

**STATUS OF THE SPACE-BASED COMPONENT
OF THE GLOBAL OBSERVING SYSTEM (GOS)
as of September 2005**

(Submitted by WMO)

This document collects essential information on satellites and instruments that form the space-based component of the GOS at the nominal date of September 2005. It is updated and extended from the first issue, CGMS XXXII WMO WP-26. It is compiled on the basis of:

- information provided by satellite operators members of CGMS at their annual meetings;
- extensive search on the Web for missing information, details and latest updates;
- books and personal notes, especially for the historical elements.

The structure of the document is such that it will provide, when updated on an annual basis, a short historical background on the various programmes, a slowly-evolving framework on current and developing systems/instruments, and a more evolutionary framework for input of the latest information on systems/instruments that are in their definition phase.

An effort has been made to provide template-like information in order to ensure compliance with homogeneity and completeness, and facilitate comparisons of programmatic elements and performances. The purpose is to provide an available and simple tool to check to which extent Earth Observation satellites fulfil WMO requirements in terms of both coverage and quality.

The following systems have been considered:

- the constellation of operational meteorological geostationary satellites;
- the constellation of operational meteorological sunsynchronous satellites;
- a selection of R&D programmes conducted by space agencies associated to CGMS.

It is regretted that a number of gaps of information or doubtful information exist, both in the chapters dealing with operational meteorological satellites (although already iterated after the first issue at CGMS XXXII) and, more, in the R&D chapter, that is new. Gaps are highlighted in **yellow colour**, and should be filled with the help of CGMS members.

The report has been prepared by Dr. Bizzarro Bizzarri as WMO consultant.

ACTIONS PROPOSED

1. CGMS to note the status of current and planned satellites of GOS at the nominal date of Sept. 2005, i.e. close to CGMS XXXIII. Special attention is called on the sections reporting the analysis of compliance of GOS with WMO requirements in terms of observation coverage (Sections 2.9 and 3.8) and instruments performance (Sections 2.10 and 3.9).
2. CGMS Members to carefully check the information reported and contribute to resolve doubtful areas and fill missing areas (**highlighted in yellow**), soon after CGMS XXXIII and in preparation of the next issue for CGMS XXXIV. To this purpose, CGMS Members are recommended to designate a contact point to interact with Dr. Bizzarri at bibizzar@tin.it.
3. CGMS members to care that, in their web sites, the information provided on satellites and instruments do not miss to provide at least the information needed for this Report.
4. CGMS members to care that their reports to CGMS XXXIV under Agenda items B1, B2, B3, C1, C2 and C3 are delivered at least one month in advance of the Session, for final tuning.

INDEX

- 1. The space-based component of the Global Observing System**
- 2. Geostationary meteorological satellites**
 - 2.1 Generalities
 - 2.2 The Meteosat programme
 - 2.3 The GOES programme
 - 2.4 The GMS and MTSAT programmes
 - 2.5 The GOMS/Elektro programme
 - 2.6 The FY-2 and FY-4 programmes
 - 2.7 The INSAT and Kalpana programmes
 - 2.8 The COMS programme
 - 2.9 Coverage provided by geostationary satellites in 2005 and 2007
 - 2.10 Comparative instrument performances
- 3. Sunsynchronous meteorological satellites**
 - 3.1 Generalities
 - 3.2 The NOAA/POES programme
 - 3.3 The DMSP programme (limited to MW sensors supportive of GOS)
 - 3.4 The NPOESS programme
 - 3.5 The EPS/Metop programme
 - 3.6 The Meteor programme
 - 3.7 The FY-1 and FY-3 programmes
 - 3.8 Coverage provided by sunsynchronous satellites in 2005 and 2007
 - 3.9 Comparative instrument performances
- 4. R&D programmes of GOS interest**
 - 4.1 Generalities
 - 4.2 ESA programmes
 - 4.2.1 Earth Watch programmes
 - 4.2.2 The ERS 1/2 and Envisat programmes
 - 4.2.3 The Earth Explorer programme
 - 4.3 NASA programmes
 - 4.3.1 The Nimbus programme, SeaSat, ERBS and UARS
 - 4.3.1.1 Instrument evolution through the Nimbus programme
 - 4.3.1.2 The SeaSat mission
 - 4.3.1.3 The ERBS mission
 - 4.3.1.4 The UARS mission
 - 4.3.2 The Landsat programme and follow-on
 - 4.3.3 The EOS programme
 - 4.3.4 The Earth System Science Pathfinder programme
 - 4.3.5 Selection of other missions relevant to GOS
 - 4.3.5.1 TRMM and the GPM
 - 4.3.5.2 Radio-occultation sounding missions
 - 4.4 The JAXA programmes
 - 4.5 The CNES programmes
 - 4.5.1 Land observing missions
 - 4.5.2 Ocean and atmosphere missions
 - 4.5.2.1 Ocean altimetry missions
 - 4.5.2.2 Atmospheric missions
 - 4.6 The ISRO programmes
 - 4.7 The RosKosmos programmes
- Annex 1** - Frequencies used from operational meteorological satellites for data transmission to the ground
 - A1.1 Geostationary satellites
 - A1.2 Sunsynchronous satellites
- Annex 2** - Definitions and acronyms (except for instruments that are listed in Annex 3)
 - A2.1 Definition of spectral bands
 - A2.2 List of acronyms (except for instruments)
- Annex 3** - Instruments of the Space-based component of GOS
 - A3.1 Operational meteorological satellites
 - A3.2 Research and Development satellites

1. The space-based component of the Global Observing System

The *Global Observing System (GOS)* is coordinated by the WMO in support of all its programmes:

- WWW (World Weather Watch)
- WCP (World Climate Programme), including:
 - World Climate Data and Monitoring Programme
 - World Climate Applications and Services Programme
 - World Climate Impact Assessment and Response Strategies Programme
 - World Climate Research Programme
 - Global Climate Observing System
- AREP (Atmospheric Research and Environment Programme), including:
 - Global Atmosphere Watch
 - World Weather Research Programme
 - Tropical Meteorology Research Programme
 - Physics and Chemistry of Clouds and Weather Modification Research Programme
- AMP (Applications of Meteorology Programme), including:
 - Agricultural Meteorology Programme
 - Aeronautical Meteorology Programme
 - Marine Meteorology and Associated Oceanographic Activities Programme
 - Public Weather Services Programme
- HWRP (Hydrology and Water Resources Programme), including:
 - Operational Hydrology Programme - Basic Systems
 - Operational Hydrology Programme - Applications and Environment
 - Programme on Water-related Issues
- Education and Training Programme
- Technical Cooperation Programme
- Regional Programme
- WSP (WMO Space Programme)
- WDPMP (Natural Disaster Prevention and Mitigation Programme).

The GOS is composed of surface-based systems and space-based systems. The space-based component of the GOS is implemented and managed by agencies linked to national meteorological services as well as two intergovernmental organizations, EUMETSAT and ESA. The *Coordination Group for Meteorological Satellites (CGMS)* is a forum for coordination of the space-based systems. CGMS Members or Observers whose primary focus is operational meteorological satellite systems are:

- CMA (China Meteorological Department)
- EUMETSAT, on behalf of 18 European Member States and 11 Cooperating States
- IMD (India Meteorological Department)
- IOC (Intergovernmental Oceanographic Commission) of UNESCO
- JMA (Japan Meteorological Agency)
- KMA (Korea Meteorological Administration)
- NOAA (National Oceanic and Atmospheric Administration)
- RosHydroMet (Hydro-Meteorological Service of the Russian Federation)
- WMO (World Meteorological Organization).

CGMS now includes several R&D space agencies, either as supportive to their corresponding operationally-oriented agency or as a full CGMS member. They are:

- CNES (Centre National d'Etudes Spatiales).
- CNSA (China National Space Agency)
- ESA (European Space Agency) on behalf of 17 European Member States and 3 Cooperating States
- ISRO (India Space Research Organisation)

- JAXA (Japan Aerospace Exploration Agency), formerly NASDA
- KARI (Korea Aerospace Research Institute)
- NASA (National Aeronautics and Space Administration)
- RosKosmos (Russian Space Agency)

The space-based component of the GOS includes:

- operational meteorological satellites in geostationary orbit
- operational meteorological satellites in sunsynchronous orbit
- a number of R&D satellites, or instruments carried by R&D satellites or R&D instruments carried on an operational satellite, that comply with certain basic WMO criteria such as:
 - relevance to WMO programmes
 - limited service continuity, though, in some cases, within an evolutionary system/instrument environment
 - data access on a non-discriminatory basis as defined by the R&D agency and according to modes standardised to the maximum extent possible
 - a formal statement made to WMO describing the commitment.

The *WMO Space Programme* agreed upon by the Fourteenth WMO Meteorological Congress in May, 2003 and entered into force on 1 January 2004, provides monitoring of the space-based component of the GOS and, specifically, of the progressive extension from the traditional operational “core” to a wider system inclusive of contributions from R&D satellites as well as the transition of appropriate R&D missions and instruments into operational services.

The *operational meteorological geostationary satellite system* includes the following series:

- the European Meteosat
- the United States of America’s GOES
- the Japanese GMS being replaced by MTSAT
- the Russian GOMS-Elektro
- the Chinese FY-2 to be replaced by FY-4
- the Indian INSAT and Kalpana (formerly MetSat)
- the Korean COMS currently being developed.

The *operational meteorological sunsynchronous satellite system* includes the following series:

- the United States of America’s POES, supported by DMSP, to converge into NPOESS
- the European Metop (close to start operations)
- the Russian Meteor
- the Chinese FY-1 to be replaced by FY-3.

The system of operational meteorological satellites in geostationary and sunsynchronous orbits is intended to fulfil the WMO requirement for:

- six satellites regularly spaced in the geostationary orbit
- four satellites optimally spaced in sunsynchronous orbits
- comparable quality across systems.

Fig. 1.1 and *Fig.1.2* show the coverage that would be provided by the space-based component of the GOS if implemented by (Fig. 1.1) six geostationary satellites 60-degrees spaced, at any time, and (Fig. 1.2) four sunsynchronous satellites at equally-spaced Local Solar Time (LST), in three hours. The figures refer to instruments with day-and-night capability (i.e. operating in IR or MW), useful field of view of 60° geocentric angle from GEO, and various swaths from LEO: typical of VIS/IR imagers (2900 km), of sounders (2200 km) and of conical scanning microwave radiometers (1400 km).

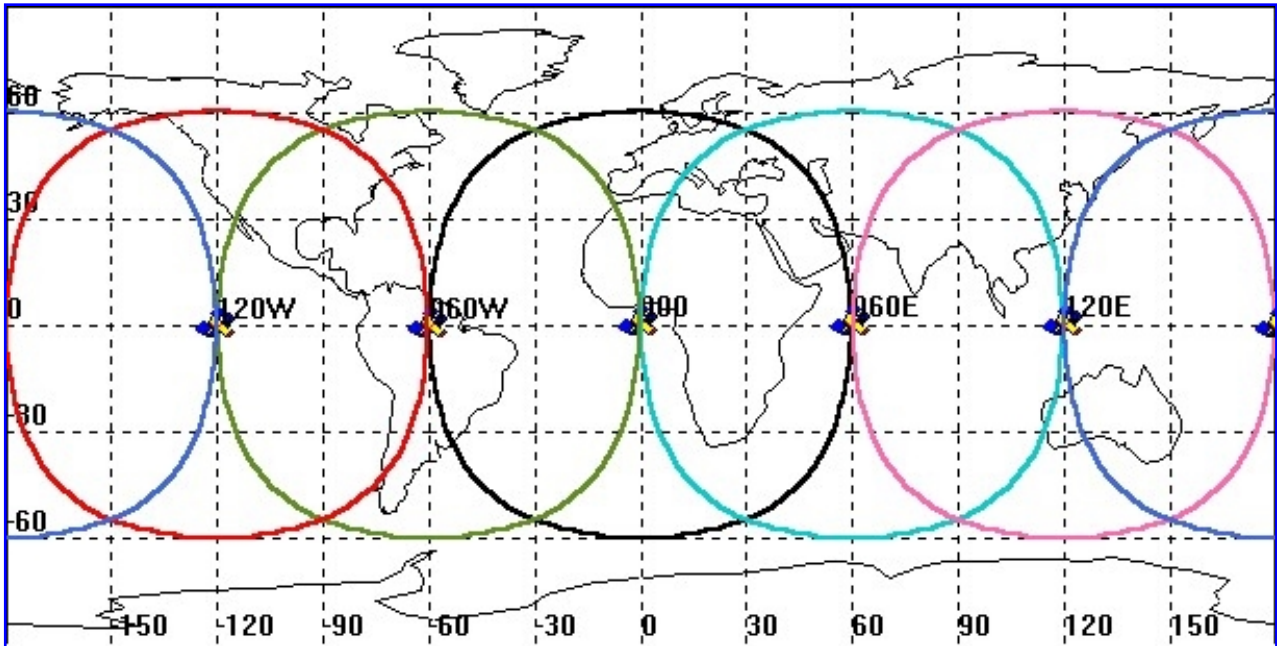

Fig. 1.1 - Coverage from six regularly-space geostationary satellites. The circles subtend a geocentric angle of 60° , considered the practical limit for quantitative observations (images extend beyond). All latitudes between 55°S and 55°N are covered.

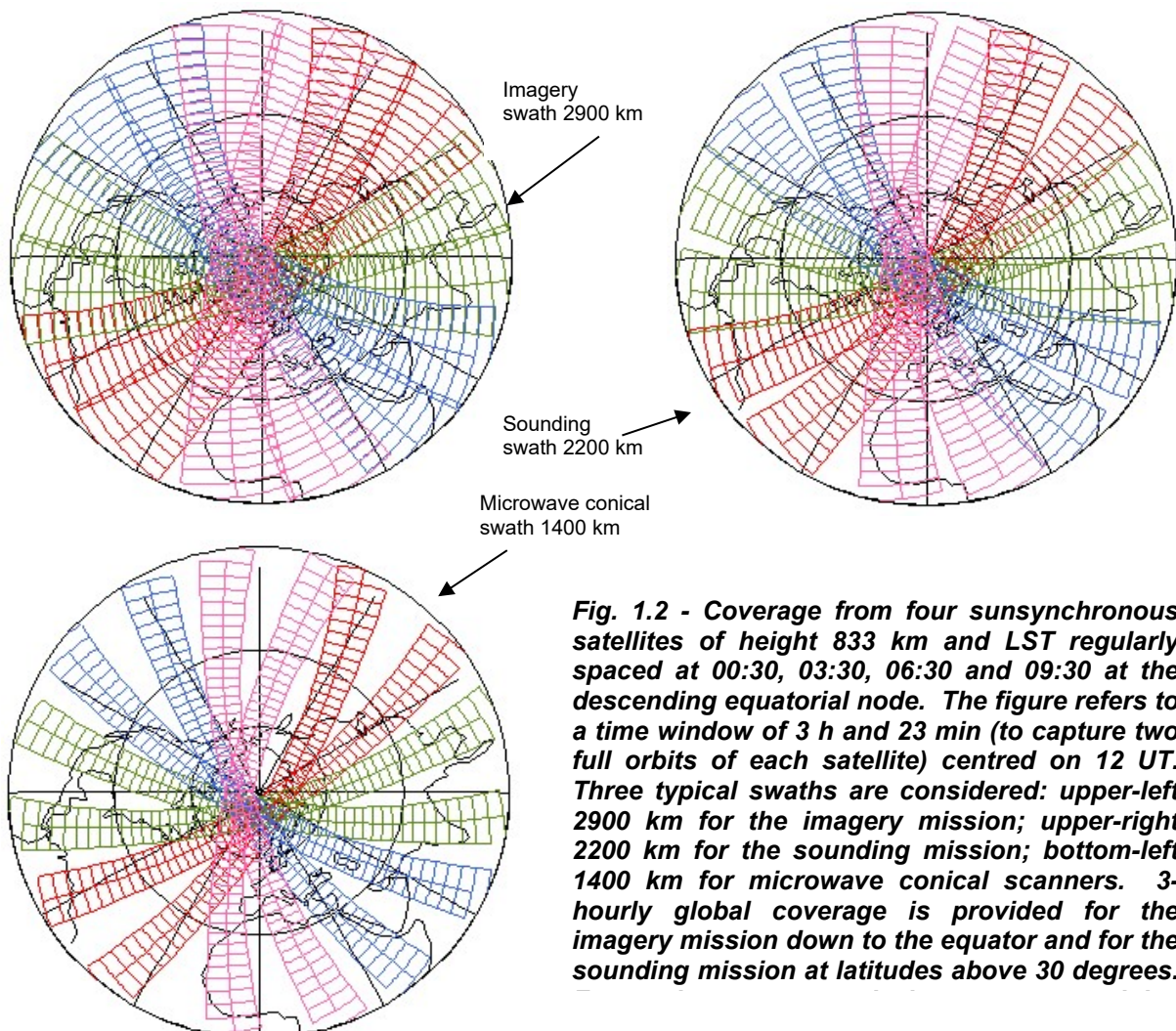

Fig. 1.2 - Coverage from four sunsynchronous satellites of height 833 km and LST regularly spaced at 00:30, 03:30, 06:30 and 09:30 at the descending equatorial node. The figure refers to a time window of 3 h and 23 min (to capture two full orbits of each satellite) centred on 12 UT. Three typical swaths are considered: upper-left 2900 km for the imagery mission; upper-right 2200 km for the sounding mission; bottom-left 1400 km for microwave conical scanners. 3-hourly global coverage is provided for the imagery mission down to the equator and for the sounding mission at latitudes above 30 degrees.

The integration of **R&D satellites** into the GOS is formally established by the WMO Congress in 2003, and coordinated under the Commission for Basic Systems (CBS) with guidance for the WMO Space Programme by the “WMO Consultative Meetings on High Level Policy on Satellite Matters” (CM) and with CBS having lead technical commission responsibility for the Space Programme.

The variety of R&D programmes is extreme, both because of the high number of national space agencies in the world, and the number of programmes within a space agency. In this Report we only include consideration of a selection of the most significant programmes for the purpose of the GOS, run by space agencies connected with CGMS. Reporting includes:

- for ESA: the ERS-1/ERS-2/Envisat satellites; the Earth Watch and Earth Explorer programmes;
- for NASA: the Nimbus, Landsat, EOS, ESSP programmes; the SeaSat/ERBS/UARS satellites; and a selection of other missions relevant for GOS;
- for JAXA: the MOS-1, MOS-1B, JERS, ADEOS-1, ADEOS-2, ALOS and GOSAT satellites;
- for CNES: the SPOT and Pléiades programmes, the PARASOL and Megha-Tropiques satellites;
- for ISRO: the IRS programme;
- for RosKosmos: the Resurs and Okean programmes, the Monitor-E satellite.

In this Report, the following information is provided, for each satellite programme:

- a short description of the programme, inclusive of some historical background
- the status of the currently operational satellites
- a description of the next satellites in the series
- the radio frequency plans for data transmission to the ground (limited to meteorological satellites)
- tables containing instrument information for currently operational and consolidated planned payloads (in *Annex 3*).

The level of detail of instrument description is uneven: the basic imagery and sounding missions are described to some extent, whereas other missions are mentioned to a lower extent.

The Report attempts to assess the degree of compliance of the operational meteorological satellite constellation with WMO requirements in respect of the following features:

- coverage from the geostationary orbit (requirement: global in the latitude belt $\pm 55^\circ$)
- coverage from the sunsynchronous orbits (requirement: global each three hours)
- suitability of the instrumentation to provide information of comparable quality across systems.

It is recognised that the parts of the Report dealing with operational meteorology and R&D programmes do not have the same level of accuracy. The reason is that, for operational meteorology, this document is an update of CGMS XXXII WMO WP-26, performed with the help of some iteration with the agencies responsible of meteorological satellite. For the R&D parts this is a new text, only in few cases iterated with R&D space agencies.

When compiling this Report, extensive use has been made of information available from the Web. On this subject, it is regretted that the trend in web architecture is in the direction of more and more spectacle, sometime at level of advertisement, and less technical information.

It is recommended that CGMS members care that, in their web sites, the information provided on satellites and instruments do not miss to provide at least the information needed for this Report.

It would have been useful to assimilate in this Report the last-minute information provided by CGMS members at the CGMS Session. Unfortunately, though the issue of this Report has been differed as much as practicable, up to 10 days prior to CGMS XXXIII only very few Members had loaded their reports on the status of current and planned satellites.

It is recommended that CGMS members care that their reports under Agenda items B1, B2, B3, C1, C2 and C3 are delivered at least one month in advance of the Session.

2. Geostationary meteorological satellites

2.1 Generalities

At the time of the First GARP Global Experiment (FGGE, 1979-80) the WMO requirement for geostationary satellites was four satellites, regularly spaced by about 90° around the equator. The coverage was varying from a maximum of over 60° latitude at the longitude of stationarity to a minimum of 45° latitude in between the stationarity points of two satellites. In the early 90's the requirement was increased to five satellites spaced 72° to rise the minimum coverage to about 52° latitude. In 2002 the requirement has been increased to six satellites optimally spaced, that extends global coverage to a minimum of 55° latitude. That also ensures that sufficient contingency margins exist in case one of the satellites is defective, waiting for the replacement.

The mission of geostationary satellites is, as a core:

- to provide cloud imagery at 30 min intervals for the purpose of nowcasting
- to derive wind vectors by tracking cloud or water vapour features, for the purpose of NWP.

Several satellites provide more than this. Some provide more frequent images, some temperature and humidity profiles by IR radiometry, some Earth radiation budget observation. In addition, several products are derived by image processing, specifically surface parameters and precipitation estimates. It is reminded that the “*Implementation Plan for Evolution of Space and Surface-based Sub-systems of the GOS*” developed by the CBS Open Programme Area Group on the Integrated Observing Systems (OPAG-IOS) (WMO/TD No. 1267 dated April 2005), recommended that, as concerns future geostationary satellites:

- *GEO Imagers - Imagers of future geostationary satellites should have improved spatial and temporal resolution (appropriate to the phenomena being observed), in particular for those spectral bands relevant for depiction of rapidly developing small-scale events and retrieval of wind information.*
- *GEO Sounders - All meteorological geostationary satellites should be equipped with hyper-spectral infrared sensors for frequent temperature/humidity sounding as well as tracer wind profiling with adequately high resolution (horizontal, vertical and time).*
- *GEO Sub-mm - An early demonstration mission on the applicability of sub-mm radiometry for precipitation estimation and cloud property definition from geostationary orbit should be provided, with a view to possible operational follow-on.*

The first two recommendations are consistent with CGMS Action 31.36, the third one with the CGMS initiative for an International Geostationary Laboratory (IGeoLab) as a mechanism to implement demonstration mission of potential operational interest through international cooperation.

2.2 The Meteosat programme

The Meteosat programme is designed to be fully redundant, with the nominal operational satellite stationary over 0°. The programme evolved through three phases:

- **Meteosat Pre-operational Programme** (Meteosat-1/2/3)
- **Meteosat Operational Programme (MOP)** (Meteosat-4/5/6/7, the last also known as **Meteosat Transition Programme** or **MTP**)
- **Meteosat Second Generation (MSG)** (Meteosat-8 to be followed by 9/10/11).

All Meteosat satellites, both of the first series (**Fig. 2.2.1**) and MSG (**Fig. 2.2.2**), are spin-stabilised. **Table 2.2.1** summarises the chronology of the Meteosat programme.

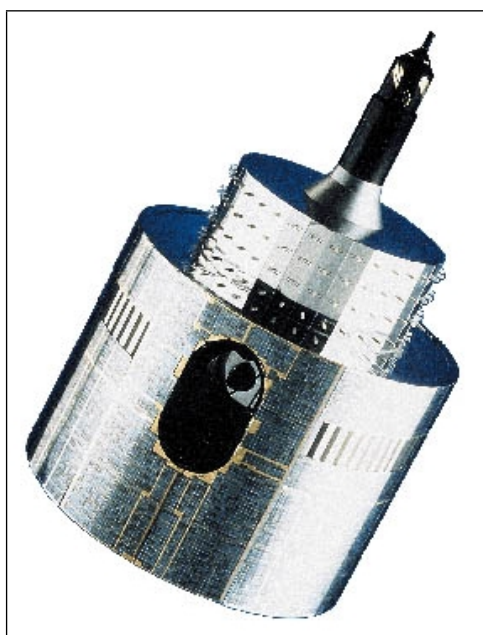

Fig. 2.2.1 - View of Meteosat/MOP.



Fig. 2.2.1 – View of Meteosat/MSG.

Table 2.2.1 - Chronology of the Meteosat programme (in bold the satellites active in Sept 2005)

Satellite	Launch	End of service	Position	Status (Sept 2005)	Instruments
Meteosat-1	23 Nov 1977	24 Nov 1979		Inactive	MVIRI, DCS
Meteosat-2	19 Jun 1981	2 Dec 1991		Inactive	MVIRI, DCS
Meteosat-3	15 Jun 1988	22 Nov 1995		Inactive	MVIRI, DCS
Meteosat-4	6 Mar 1989	8 Nov 1995		Inactive	MVIRI, DCS
Meteosat-5	2 Mar 1991	expected ≥ 2006	63°E	Operational	MVIRI, DCS
Meteosat-6	20 Nov 1993	expected ≥ 2007	9°E	Backup (+ rapid scan)	MVIRI, DCS
Meteosat-7	3 Sep 1997	expected ≥ 2008	0°	Operational	MVIRI, DCS
Meteosat-8 (MSG-1)	28 Aug 2002	expected ≥ 2009	3.6°W	Operational	SEVIRI, GERB, DCS, GEOSAR
Meteosat-9	Dec 2005	expected ≥ 2012		Close to be launched	SEVIRI, GERB, DCS, GEOSAR
Meteosat-10	2009	expected ≥ 2016		Being built	SEVIRI, GERB, DCS, GEOSAR

Meteosat-11	2011	expected \geq 2018		Planned	SEVIRI, GERB, DCS, GEOSAR
MTG	2015	expected \geq 2020		Being defined	Being defined

At mid-2005, three satellites of the MOP series are still active (Meteosat 5, 6 and 7) and the commissioning of the prototype of the MSG series (MSG-1 = Meteosat-8) has been completed.

Meteosat-5

Launched in March 1991, Meteosat-5 was moved in July 1998 over the longitude of 63°E to support INDOEX (Indian Ocean Experiment). Since then it still continues to provide an operational service. It could in principle be operated through 2006 and beyond.

Meteosat-6

Launched in November 1993, Meteosat-6 was moved in August 2000 over the longitude of 9°W to support MAP (Mesoscale Alpine Programme) by providing frequent imagery (at 10 min intervals) over a limited area. Since then, the rapid scan service is being continued. It also constitutes the backup of Meteosat-7, the nominal operational satellite of the MOP series. After the launch of MSG-1, in October 2002 it has been moved over 10°E. It could in principle be operated through 2007 and beyond.

Meteosat-7

Previously known as MTP (Meteosat Transition Programme), Meteosat-7, launched in September 1997, is the nominal MOP operational satellite over the 0° longitude. It will be operated till at least the whole 2008 in parallel with MSG-1 to ensure a smooth transition between the two satellite generations.

Payload of Meteosat 1 to 7

All Meteosat satellites till Meteosat-7 are equipped with a single sensor:

- ***MVIRI (Meteosat Visible and Infra Red Imager)***, a 3-channel VIS/IR radiometer with 5 km resolution in two IR channels and 2.5 km in VIS; image cycle 30 min (or less, over a progressively limited area, as with Meteosat-6). See instrument sheet in Annex A3.1.
- ***Data Collection Service (DCS)*** to relay *in situ* observations from Data Collection Platforms (DCP) - Main features:
 - uplink: frequencies 402.0-402.1 MHz for 33 international channels, 402.1-402.2 MHz for 33 regional channels; bandwidth 3.0 kHz each, data rate 100 bps, polarisation right-hand circular.

Data transmission from Meteosat 1 to 7

Image data are transmitted in real time to the:

- ***Primary Ground Station (PGS)***. Main transmission characteristics:
 - frequency 1686.833 MHz, bandwidth 1.3332 MHz, linear polarisation, data rate 333 kbps (nominal mode) and 5.4 MHz at data rate of 2.66 Mbps (burst mode).

After pre-processing, data are re-transmitted to user stations in S-band. There are two services:

- ***HRIDS, High Resolution Image Dissemination Service***, for digital images
- ***WEFAX Dissemination Service***, for analogue images.

Correspondingly, there are two types of user stations:

- ***PDUS (Primary Data User Station)*** - Main features:
 - frequency: 1694.5 MHz; bandwidth: 1.5 MHz; polarisation: linear
 - antenna diameter \sim 3 m, G/T \sim 10.5 dB/K, data rate 166 kbps.
- ***SDUS (Secondary Data User Station)*** - Main features:
 - frequency: 1691 (dedicated) and 1694.5 MHz (shared); bandwidth: 1.5 MHz; polarisation: linear
 - antenna diameter \sim 1.5 m, G/T \sim 2.5 dB/K, base band 1.6 kHz (analogue).

The satellites of the operational series (Meteosat 4 to 7) also provide:

- ***Meteorological Data Distribution (MDD) Service*** to relay meteorological maps (gridded or facsimile) and other data from national meteorological centres to remote user terminals - Main features:
 - uplink: from up to four centres (currently from three: Rome, Bracknell and Toulouse);
 - user terminals: frequency 1695.68-1695.80 MHz (four 20-kHz-width channels spaced 31.2 kHz), antenna diameter ~ 2.4 m, G/T ~ 6.0 dB/K, data rate 2.4 kbps, linear polarisation.

Meteosat-8

Launched in August 2002, Meteosat-8, previously known as MSG-1, i.e. first flight model of the ***Meteosat Second Generation*** has completed its commissioning phase in December 2003 at the 10.5°W position. The satellite has been moved during January 2004 to a 3.4°W position to become operational in parallel with Meteosat-7.

Payload of Meteosat Second Generation

- ***SEVIRI (Spinning Enhanced VIS and IR Imager)***, a 12-channel VIS/IR radiometer with 3 km resolution in 11 VIS/IR narrow-bandwidth channels and 1 km in one broad-bandwidth VIS channel, 15 min image cycle. See instrument sheet in Annex A3.1.
- ***GERB (Geostationary Earth Radiation Budget experiment)***, 2-channel broad-band radiometer for Earth Radiation Budget, 42 km resolution, image cycle 5 min (or 15 min after integration to meet SNR requirements). See instrument sheet in Annex A3.1.
- ***Data Collection Service (DCS)*** to relay *in situ* observations from Data Collection Platforms (DCP) - Main features:
 - uplink: frequency 402.0-402.1 MHz for 33 international channels with 3 kHz bandwidth, 402.10-402.44 for 223 regional channels with 1.5 kHz bandwidth, 401.7-402.0 for 210 channels with 1.5 kHz bandwidth as contingency; data rate 100 bps, polarisation right-hand circular.
- ***GEOSAR (Geostationary Search And Rescue)***, to relay distress signals from beacons at 406 MHz to a central European station of the international Search & Rescue system.

Data transmission from Meteosat Second Generation

Image data are transmitted in real time to the:

- ***Primary Ground Station (PGS)***. Main transmission characteristics:
 - frequency 1686.833 MHz, bandwidth 5.4 MHz linear polarisation, data rate 3.2 Mbps.

After pre-processing, data are re-transmitted to user stations in S-band. There are two transmission services, both digital:

- ***HRIT, High Rate Information Transmission***
- ***LRIT, Low Rate Information Transmission***

Correspondingly, there are two types of user stations:

- ***HRUS (High Rate User Station)*** - Main features:
 - frequency: 1695.15 MHz; bandwidth: 1.96 MHz; polarisation: linear
 - antenna diameter ~ 3 m, G/T ~ 14 dB/K, data rate 1.0 Mbps;
- ***LRUS (Low Rate User Station)*** - Main features:
 - frequency: 1691.0 MHz; bandwidth: 0.66 MHz; polarisation: linear
 - antenna diameter ~ 2 m, G/T ~ 6 dB/K, data rate 128 kbps.

In addition, continuation is provided to:

- ***Meteorological Data Distribution (MDD) Service*** to relay meteorological maps and other data from national meteorological centres to remote user terminals - Main features:
 - uplink: from up to four centres (currently from three: Rome, Bracknell and Toulouse);
 - user terminals: not required in so far as the data are made available to HRUS and LRUS.

The EUMETCast service

As a matter of fact, the Meteosat-8 High Power Amplifier basic for the HRIT and LRIT services failed in orbit. Therefore the data to be disseminated (both images and DCP/MDD data) are currently transmitted by means of commercial satellites using the Digital Video Broadcast (DVB) system. This is called ***EUMETCast service***. There are two types of user terminals:

- Ku-band terminals (11.096 GHz) served by the HotBird satellites managed by EUTELSAT, optimally covering Europe; antenna diameter 85-180 cm; polarisation linear; rate 27.5 M symbols/s;
- C-band terminals (3.727 GHz) served by the Atlantic Bird satellites managed by EUTELSAT, covering also Africa, Eastern North/Central America and Western Asia; antenna diameter 2.4-3.7 m; polarisation left-hand circular; rate 5.96 M symbols/s.

Plans for Meteosat Third Generation

Planning for MTG (Meteosat Third Generation) has started in early 2001 and, at mid-2005, initial requirements have been agreed and preliminary industrial studies are under way. The prototype MTG should be ready for launch in 2015. The following missions/instruments are being defined.

- ***MTG imager(s)*** - One instruments would address the following requirements:
 - High Resolution Fast Imagery, driven by nowcasting applications, with about 5 VIS/IR channels, resolution 0.5-1.0 km, cycle 2-5 min over a limited area (1/3 of the visible disk);
 - Full Disk High Spectral Imagery, evolution of MSG/SEVIRI, with about 15 VIS/IR channels, resolution 1.0-3.0 km, cycle 5-10 min; optional features such as a spectrometer in the 4.3-5.5 μm band (to be considered if there isn't an independent sounder) and sets of channels in the 14 μm band and around 0.76 μm (for cloud top height) also are being studied.
- ***MTG sounder*** - An IR spectrometer is foreseen, to provide high vertical resolution. Main features:
 - range 4.0 to $\geq 14.3 \mu\text{m}$, resolution 0.5 cm^{-1} (goal at 14 μm) to 1.25 cm^{-1} (threshold at 5 μm)
 - geometric resolution: from 3 to 6 km (at 5 μm) and 6 to 12 km (at 14 μm)
 - cycle: 15 to 30 min for full disk, correspondingly less for limited areas.
- ***MTG lightning mapper*** - CCD camera operating at 777.4 nm (O_2), resolution 5-10 km, time resolution $\sim 1 \text{ ms}$, probability of lightning detection $> 90 \%$, probability of false detection $< 1 \text{ s}^{-1}$.
- ***Follow-on of GERB*** - Not in the baseline, could be considered at a later stage.
- ***Chemistry mission by UV/VIS spectroscopy*** - Requirements and instrument definition being developed. It could be considered as a cooperative programme with the European Union and ESA.
- ***Precipitation mission by MW/Sub-mm imagery/sounding*** - Being considered as a side activity.

Instrument sheets of the MTG imager(s), sounder and lightning mapper are provided in Annex A3.1.

2.3 The GOES programme

The GOES programme is designed to cover two positions (GOES-W at 135°W, GOES-E at 75°W) by two satellites, with one common backup satellite in intermediate position (105°W) to be moved in replacement of any of the two in case of failure. The programme evolved through the following phases:

- the precursor *ATS (Application Technology Satellite)*, ATS-1 and ATS-3 spin-stabilised, ATS-6 three-axis stabilised;
- the prototype *SMS (Synchronous Meteorological Satellite)* (SMS-1 and SMS-2) and the first three *GOES (Geostationary Operational Environmental Satellite)* (GOES-1/2/3), spin-stabilised, equipped with an imager (VISSR);
- GOES 4 to 7, with VISSR upgraded to VAS to provide either imagery or sounding;
- GOES-8 and follow-on (to continue to GOES-16), three-axis stabilised, equipped with independent IMAGER and SOUNDER.

Table 2.3.1 records the chronology of the GOES programme.

Table 2.3.1 - Chronology of the GOES programme (in bold the satellites active in Sept 2005)

Satellite	Launch	End of service	Position	Status (Sept 2005)	Instruments
ATS-1	6 Dec 1966	1 Dec 1978		Inactive	SSCC
ATS-3	6 Nov 1967	1 Dec 1978		Inactive	MSSCC
ATS-6	30 Apr 1974	3 Aug 1979		Inactive	VHRR
SMS-1	17 May 1974	21 Jan 1981		Inactive	VISSR, DCIS, SEM
SMS-2	6 Feb 1975	5 Aug 1982		Inactive	VISSR, DCIS, SEM
GOES-1	16 Oct 1975	7 Mar 1985		Inactive	VISSR, DCIS, SEM
GOES-2	16 Jun 1977	during 1993		Inactive	VISSR, DCIS, SEM
GOES-3	16 Jun 1978	during 1993		Inactive	VISSR, DCIS, SEM
GOES-4	9 Sep 1980	11 Nov 1988		Inactive	VAS, DCIS, SEM
GOES-5	22 May 1981	18 Jul 1990		Inactive	VAS, DCIS, SEM
GOES-6	28 Apr 1983	during 1989		Inactive	VAS, DCIS, SEM
GOES-7	26 Feb 1987	11 Jan 1996		Inactive	VAS, DCIS, SEM
GOES-8	13 Apr 1994	5 May 2004		Inactive	IMAGER, SOUNDER, DCIS, SEM, GEOSAR
GOES-9	23 May 1995	expected ≥ 2005	155°E	Operational (partly)	IMAGER, SOUNDER, DCIS, SEM, GEOSAR
GOES-10	25 Apr 1997	expected ≥ 2006	135°W	Operational	IMAGER, SOUNDER, DCIS, SEM, GEOSAR
GOES-11	3 May 2000	expected ≥ 2007	105°W	Standby	IMAGER, SOUNDER, DCIS, SEM, GEOSAR
GOES-12	23 Jul 2001	expected ≥ 2008	75°W	Operational	IMAGER, SOUNDER, DCIS, SEM, SXI, GEOSAR
GOES-13	Nov 2005	expected ≥ 2011		Ready for launch	IMAGER, SOUNDER, DCIS, SEM, SXI, GEOSAR
GOES-14	Apr 2007	expected ≥ 2014		Being built	IMAGER, SOUNDER, DCIS, SEM, SXI, GEOSAR

GOES-15	Oct 2008	expected \geq 2015		Planned	IMAGER, SOUNDER, DCIS, SEM, SXI, GEOSAR
GOES-R	Apr 2012	expected \geq 2019		Being defined	ABI, HES + TBD

Short information on past series

ATS-1 and ATS-2 were equipped, respectively, with SSCC (Spin Scan Cloud Camera) e MSSCC (Multi-color SSCC). ATS-6 was equipped with VHRR (Very High Resolution Radiometer) that, afterwards, became operational on the INSAT satellites.

The SMS-1, SMS-2 and GOES 1 to 3 were equipped with:

- **VISSR (Visible and Infrared Spin Scan Radiometer)**, a 2-channel VIS/IR radiometer with resolution 0.9 km in VIS (0.55-0.75 μm) and 7 km in IR (10.5-12.6 μm); cycle 30 min.

On GOES 4 to 7 VISSR was upgraded to enable temperature/humidity sounding, alternate with images:

- **VAS (VISSR Atmospheric Sounder)**, adding to the two VISSR channels further 12 narrow-bandwidth channels centred at 3.94, 4.44, 4.51, 6.7, 7.2, 11.2, 12.7, 13.3, 14.0, 14.2, 14.5 and 14.7 μm ; resolution 7 or 14 km depending on the channel, cycle lasting as necessary to collect enough energy as required for profile retrieval; generally used for limited area scanning.

Fig. 2.3.1 and **Fig. 2.3.2** show the change of structure from the GOES 4/5/6/7 spacecrafts to the current series (GOES-8 and follow-on).



Fig. 2.3.1 - View of GOES-

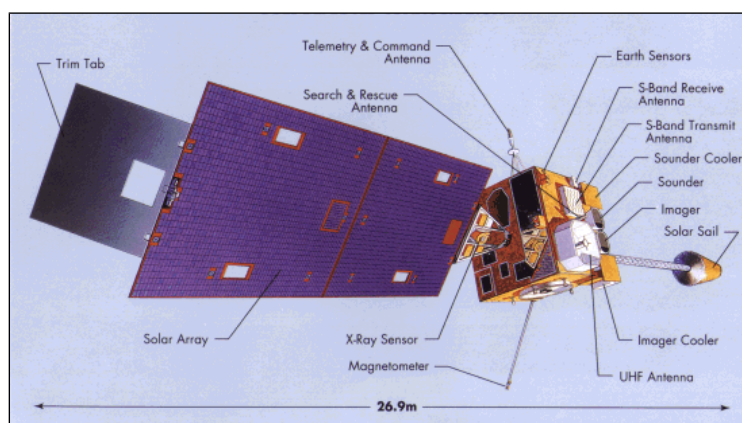

Fig. 2.3.2 – Sketch view of GOES-8 and follow-on.

GOES-8

Launched in April 1994, GOES-8 was the first of the 3-axis stabilised series. It has served as GOES-E at 75°W until spring 2003, when it was replaced by GOES-12. Then it has been moved to 165°E to serve as backup to GOES-9. It has several operational limitations.

GOES-9

Launched in May 1995, GOES-9 has served as GOES-W at 135°W until 1999, when the accumulation of a number of malfunctions led to transfer operations to GOES-10 and place GOES-9 in a standby position at 106°W. In early 2003 it has been moved to 155°E to partially fill the gap due to the end-of-life of GMS-5, waiting for the launch of MTSAT.

GOES-10 (current GOES-W)

Launched in April 1997, GOES-10 was originally placed in the standby position at 105°W. Thereafter, in 1999, it has replaced GOES-9 as the operational satellite at 135°W.

GOES-11 (current common backup of GOES-E and GOES-W)

Launched in May 2000, GOES-11 is the current standby satellite at 105°W between GOES 10 and 12.

GOES-12 (current GOES-E)

Launched in July 2001, GOES-12 was originally placed in the standby position at 105°W. Thereafter, spring 2003, it has replaced GOES-8 as the operational satellite at 75°W.

Payload of GOES 8 to 15

- **IMAGER**, a 5-channel VIS/IR radiometer with 4.0 km resolution in four IR channels and 1.0 km in the VIS channel, 30 min image cycle (less for limited areas). See instrument sheet in Annex A3.1.
- **SOUNDER**, a 19-channel IR sounding radiometer (including one in VIS) with 8.0 km resolution, generally used for limited areas (e.g., 1000 x 1000 km² in 5 min, 3000 x 3000 km² in 42 min: it would be 8 h for full disk). See instrument sheet in Annex A3.1.
- **Data Collection and Interrogation Service (DCIS)** to relay *in situ* observations from Data Collection Platforms (DCP) either transmitting at fixed times or after interrogation. This mission is in use, with progressive updating, since SMS-1. Main features:
 - uplink: two bands, frequencies 401.900 MHz and 402.200 MHz, bandwidth 350 kHz each for a total of 223 channels of bandwidth 3 kHz; data rate 100 bps, polarisation right-hand circular;
 - downlink for interrogation: two frequencies, 468.8250 MHz and 468.8375 MHz, bandwidths 200 kHz each, data rate 100 bps, polarisation right-hand circular.
- **Space Environment Monitoring (SEM)**, in use, with progressive updating, since SMS-1. A set of instruments for *in situ* measurement, at the platform's altitude, of:
 - EPS (Energetic Particles Sensor) for low-energy electron, proton and alpha particles
 - HEPAD (High Energy Proton and Alpha Particles Detector)
 - XRS (X-Ray Sensor)
 - two redundant Magnetometers.
- **Solar X-ray Imager (SXI)**, starting with GOES-12, to image the sun each minute.
- **PDR, Processed Data Relay**, associated to the WEFAX service (in use since SMS-1).
- **GEOSAR (Geostationary Search And Rescue)**, to relay distress signals from beacons at 406 MHz to the American Search & Rescue Coordination Center.

Data transmission from GOES

GOES data are transmitted in real time to the:

- **Command and Data Acquisition station (CDA)**. Main transmission characteristics:
 - frequency 1676.2 MHz, bandwidth 6.0 MHz, linear polarisation, data rate 3.0 Mbps.

Afterwards, data are re-transmitted to several centres in several modes. The ones that concern most users occurs after pre-processing, to two types of S-band stations:

- **GVAR (GOES Variable Data Format)**, for processed image and sounding data - Main features:
 - frequency: 1685.7 MHz; bandwidth: 5.0 MHz; polarisation: linear
 - antenna diameter ~ 3 m, G/T ~ 16 dB/K, data rate 2.1 Mbps;
- **WEFAX**, for selected image frames - Main features:
 - frequency: 1691.0 MHz; bandwidth: 1.0 MHz; polarisation: linear
 - antenna diameter ~ 1.5 m, G/T ~ 2.5 dB/K, base band 1.6 kHz (analogue).

The WEFAX mode is fully consistent with that one of Meteosat 1 to 7. GOES-12 has started to alternate the analogue WEFAX transmission to the digital mode as MSG (LRIT), i.e. for stations:

- **LRUS (Low Rate User Station)** - Main features:
 - frequency: 1691.0 MHz; bandwidth: 0.66 MHz; polarisation: linear
 - antenna diameter ~ 2 m, G/T ~ 6 dB/K, data rate 128 kbps.

It is foreseen that, during 2005, WEFAX will definitively be replaced by LRIT.

Plans for GOES next generation starting with GOES-R (GOES-16)

Planning for GOES-R has started in early 2001 and is making progress under the guidance of the yearly GOES User Conference. The launch should be in 2012. The following instruments are being defined.

- **ABI (Advanced Baseline Imager)**, with about 16 VIS/IR channels, resolution 2 km for 12 channels, 0.5 km for one VIS channel, 1.0 km for other three SW channels, cycle 15 min for full disk, 5 min for 3000 x 5000 km² (“CONUS”, Continental United States), 30 s for 1000 x 1000 km²;
- **HES (Hyperspectral Environmental Suite)**, currently defined to address several objectives: full disk sounding, limited-area nowcasting and coastal water observation (ocean colour). Spectral range for sounding from 4.44 μm (option 3.68 μm) to 15.38 μm (with gaps) with resolving power changing with band from 1000 to 3000, plus one VIS channel; for coastal waters about 14 VIS/NIR channel of 20 nm width and possibly 3 SWIR channels of 30 or 50 nm width and the split IR window at 11 and 12 μm. Geometric resolution: 2 to 10 km for sounding (0.5-1.0 km for the VIS channel), 0.15 to 2 km for coastal waters. Cycle: maximum 1 h for full disk, down to minutes depending on operating mode. It is realised that HES could be a suite of distinct instruments.
- **GLM (Geostationary Lightning Mapper)**, CCD camera operating at 777.4 nm (O₂), resolution 8 km, time resolution 2 ms, probability of lightning detection > 90 %, probability of false detection < 1 s⁻¹.
- **MW/Sub-mm imaging/sounder for precipitation.**

Instrument sheets of ABI, HES and LMS are provided in Annex A3.1.

2.4 The GMS and MTSAT programmes

The Japanese *GMS (Geostationary Meteorological Satellite)*¹ was a spin-stabilised satellite (*Fig. 2.4.1*) to cover the position 140°E. Its successor, *MTSAT (Multi-functional Transport Satellite)*, is 3-axis stabilised (*Fig. 2.4.2*), coupling the meteorological mission to an aviation navigation one. *Table 2.4.1* records the chronology of the GMS/MTSAT programme.

Table 2.4.1 - Chronology of the GMS/MTSAT programme (in bold the satellites active in Sept 2005)

Satellite	Launch	End of service	Position	Status (Sept 2005)	Instruments
GMS-1	14 Jul 1977	30 Jun 1989		Inactive	VISSR, DCS
GMS-2	11 Aug 1981	20 Nov 1987		Inactive	VISSR, DCS
GMS-3	3 Aug 1984	22 Jun 1995		Inactive	VISSR, DCS
GMS-4	6 Sep 1989	24 Feb 2000		Inactive	VISSR, DCS
GMS-5	18 Mar 1995	21 Jul 2005		Inactive	VISSR, DCS
MTSAT-1R	26 Feb 2005	expected ≥ 2015	140°E	Operational	JAMI, DCS
MTSAT-2	March 2006	expected ≥ 2016		Ready for launch	IMAGER, DCS

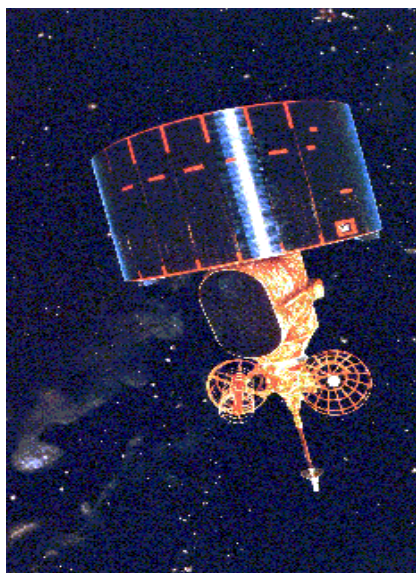

Fig. 2.4.1-View of GMS

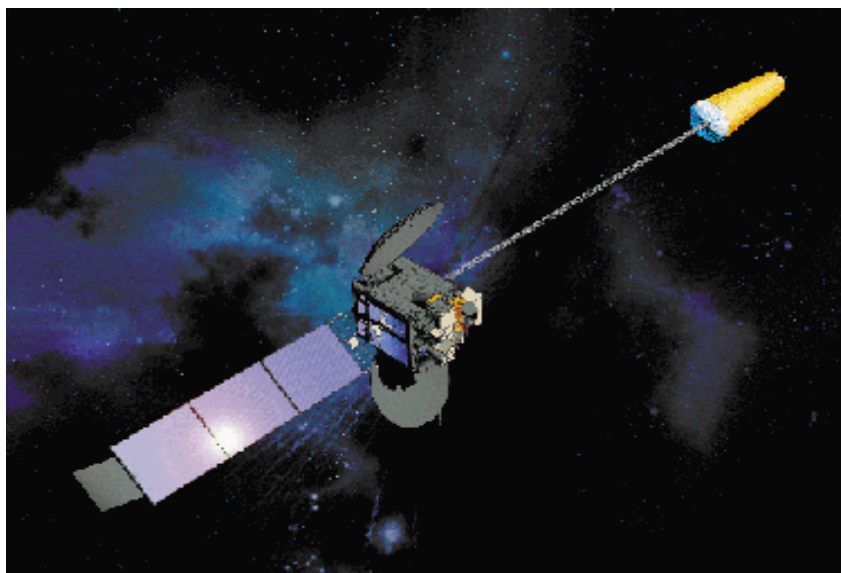

Fig. 2.4.2-View of MTSAT-1R

The last GMS satellite in the series, GMS-5, was equipped with:

- *VISSR (Visible and Infrared Spin-Scan Radiometer)*, a 4-channel VIS/IR radiometer with 5.0 km resolution in three IR channels (6.5-7.0 μm , 10.5-11.5 μm and 11.5-12.5 μm) and 1.25 km in the VIS channel (0.55-0.90 μm), 30 min image cycle (less for limited areas).
- *DCS (Data Collection Service)*, also implemented on MTSAT (see next).

The first launch of MTSAT failed in 1999. *MTSAT-1R* has been launched on 26 February 2005, to be followed by *MTSAT-2* by the end of March 2006 (to be placed in standby until 2010).

Payload of MTSAT

- *JAMI (Japanese Advanced Meteorological Imager)*, a 5-channel VIS/IR radiometer with 4.0 km resolution in four IR channels and 1.0 km in the VIS channel, 30 min image cycle (half disk in 15 min image cycle). Re-named *IMAGER* on MTSAT-2. See instrument sheet in Annex A3.1.

¹ Original name: *Himawari*, that means “Sun flower”.

- **Data Collection Service (DCS)** to relay *in situ* observations from Data Collection Platforms (DCP) either transmitting at fixed times or after interrogation - Main features:
 - uplink: two bands, frequencies 402.0-402.1 MHz for international DCP's (33 channels of bandwidth 3 kHz), 402.1-402.4 MHz for regional DCPs (100 channels of bandwidth 3 kHz); data rate 100-300 bps, polarisation right-hand circular;
 - downlink for interrogation: frequency 468.875 MHz for international DCP's, 468.924 MHz for regional DCP's, bandwidth 5.0 kHz each, data rate 300 bps, polarisation right-hand circular.

Data transmission from MTSAT-1R

MTSAT-1R images are transmitted in real time to the:

- **Command and Data Acquisition station (CDA)**. Main transmission characteristics:
 - frequency 1677.0 MHz, bandwidth 8.2 MHz, linear polarisation, data rate 2.7 Mbps.

Afterwards, MTSAT-1R images are re-transmitted to user stations. Two kinds of service in new formats, HRIT and LRIT, were initiated at the start of MTSAT-1R operation. Initially, MTSAT-1R has been providing compatibility with existing receiving stations for GMS. The compatible service of HiRID and WEFAX will be continued till end-2007 to facilitate users' preparation for the transition.

- **HiRID (High Resolution Imager Data)** provides service continuity for the Medium-scale Data Utilisation Stations (MDUS) until end-2007. Main features:
 - frequency: 1687.1 MHz; bandwidth: 2.0 MHz; polarisation: linear
 - antenna diameter ~ 4 m, G/T ~ 10.4 dB/K, data rate 660 kbps;
- **HRIT (High Resolution Information Transmission)** was started on 28 June 2005. Main features:
 - frequency: 1687.1 MHz; bandwidth: 5.2 MHz; polarisation: linear
 - antenna diameter ~ 4 m, G/T ~ 10.4 dB/K, data rate 3.5 Mbps;
- **WEFAX (Weather Facsimile)** will be time-shared till end-2007 and then replaced by the **LRIT**, that is similar to MSG and GOES. Main features:
 - frequency: 1691.0 MHz; bandwidth: 250 kHz; polarisation: linear
 - antenna diameter ~ 2.5 m, G/T ~ 3 dB/K, base band 1.6 kHz (analogue).
- **LRIT (Low Rate Information Transmission)** was started on 28 June 2005. Main features:
 - frequency: 1691.0 MHz; bandwidth: 250 kHz; polarisation: linear
 - antenna diameter ~ 2.5 m, G/T ~ 3 dB/K, data rate 75 kbps.

2.5 The GOMS/Elektro programme

The Russian programme *GOMS* (*Geostationary Operational Meteorological Satellites*), also called *Elektro*, is based on 3-axis stabilized satellites due to cover the 76°E position. The first spacecraft, named GOMS-N1 (*Fig. 2.5.1*), was launched in 1994, but its functioning experienced several problem till final deactivation in 1998. The next flight unit is now being prepared, as a first satellite of a new series *Elektro-L* (*Fig. 2.5.2*). *Table 2.5.1* records the chronology of the GOMS/Elektro programme.

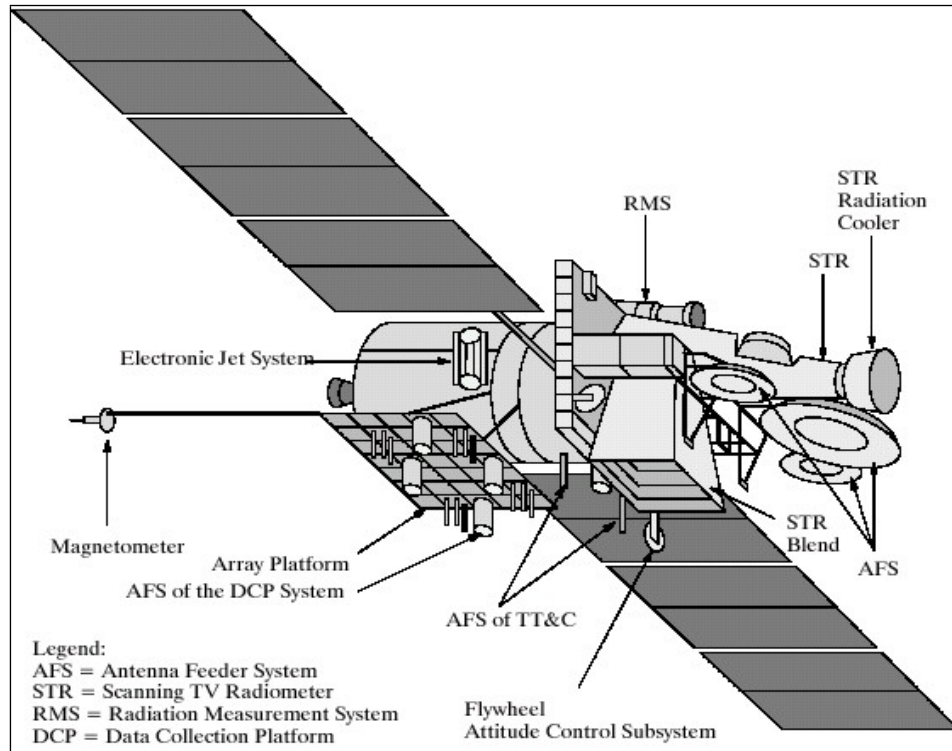

Fig. 2.5.1 – Sketch view of GOMS-N1.

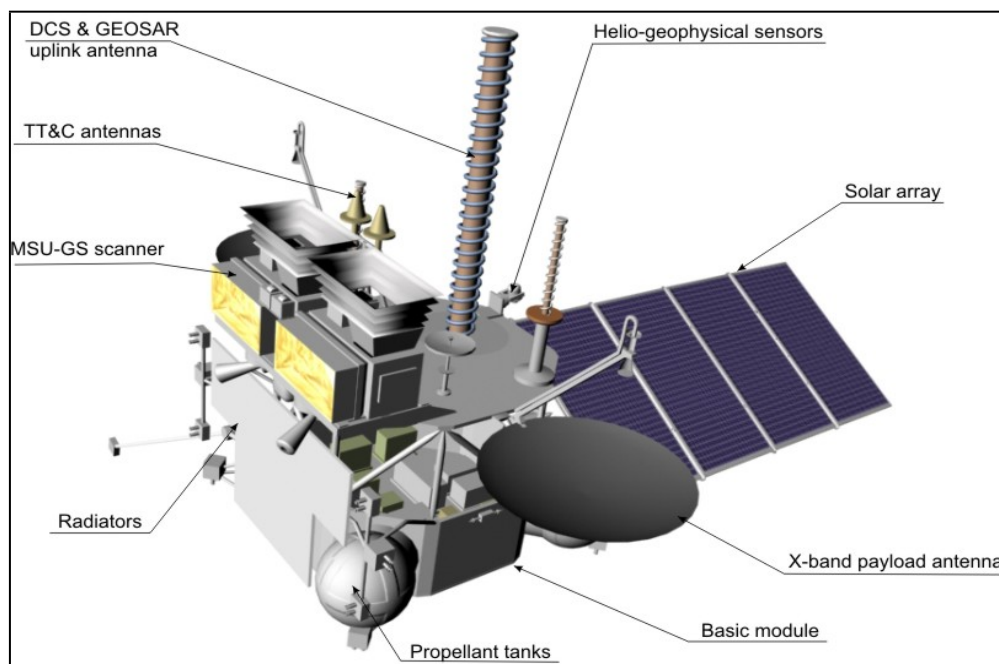

Fig. 2.5.2 – Sketch view of Electro-L N1.

Table 2.5.1 - Chronology of the GOMS / Elektro programme (no satellite active at Sept 2005)

Satellite	Launch	End of service	Position	Status (Sept 2005)	Instruments
GOMS-1	31 Oct 1994	during 1998	76°E	Inactive	STR, DCS, RMS
Elektro-L-1	2007	expected \geq 2016	76°E	Being built	MSU-GS, DCS, HMS, GEOSAR
Elektro-L-2	2009	expected \geq 2018	76°E	Planned	MSU-GS, DCS, HMS, GEOSAR

GOMS-1 was equipped with the radiometer:

- **STR (Scanning TV Radiometer)**: it was a 3-channels VIS/IR radiometer; 6.5 km resolution in two IR channels (6.0-7.0 μm and 10.5-12.5 μm), 1.25 km in VIS (0.46-0.70 μm), 30 min image cycle.

Elektro-L is being built for a first launch in 2007 and a second in 2009.

Payload of Elektro-L

- **MSU-GS**, a 10-channel VIS/IR imaging radiometer with 4.0 km resolution in seven IR channels and 1.0 km in three VIS channels, 15-30 min image cycle. See instrument sheet in Annex A3.1.
- **Data Collection Service (DCS)**, to relay *in situ* observations from Data Collection Platforms (DCP) at fixed times - Main features:
 - uplink: three bands, frequencies 402.0-402.1 MHz for international DCP's (33 channels of bandwidth 3 kHz), 401.5-402.0 MHz and 402.1-402.5 MHz for regional DCP's (300 channels of bandwidth 3 kHz); data rate 100 bps, polarisation right-hand circular;
 - downlink for DCS ground acquisition station: 1697 MHz, bandwidths 2 MHz, data rate 100-1200 bps, linear polarisation.
- **Heliogeophysical Measurements System (HMS)**, for *in situ* measurement of charged particles of the solar wind at the platform's altitude.
- **GEOSAR (Geostationary Search And Rescue)**, to relay distress signals from beacons at 406 MHz to stations of the international COSPAS/SARSAT Search & Rescue system.

Data transmission from Elektro-L

Elektro-L data are transmitted in real time to the:

- **Raw Data Acquisition Station (RDAS)** for MSU-GS and HMS. Main features:
 - frequency: 7475 MHz; bandwidth: 30 MHz; polarisation: right-hand circular; data rate 15.36 Mbps.

Afterwards, data are re-transmitted to user stations. The broadcast will comply with the HRIT and LRIT standards:

- **HRIT (High Rate Information Transmission)**. Main features:
 - frequency: 1691.0 MHz; bandwidth: 2 MHz; polarisation: right-hand circular
 - antenna diameter \sim 3.7 m, G/T \sim 12 dB/K, data rate 0.665-1 Mbps;
- **LRIT (Low Rate Information Transmission)**, similar to MSG, GOES and MTSAT. Main features:
 - frequency: 1691.0 MHz; bandwidth: 200 kHz; polarisation: right-hand circular
 - antenna diameter \sim 1.5 m, G/T \sim 4 dB/K, data rate 64-128 kbps.
- **DCS Acquisition station (DCSA)**. Main features:
 - frequency 1697 MHz, bandwidth 2 MHz, linear polarisation, data rate 100-1200 bps.

2.6 The FY-2 and FY-4 programmes

The Chinese series *FY-2 (Feng-Yun-2)*², operational since 1997, due to cover the 105°E position, is spin stabilised (*Fig. 2.6.1*). The next generation, *FY-4* (see *Fig. 2.6.2*), to take service around 2012, will be 3-axis stabilised. *Table 2.6.1* records the chronology of the FY-2/F-4 programme.

Table 2.6.1 - Chronology of the FY-2 programme (in bold the satellites active in Sept 2005)

Satellite	Launch	End of service	Position	Status (Sept 2005)	Instruments
FY-2A	10 Jun 1997	????????	86.5°E	Inactive	S-VISSR, DCS, SEN
FY-2B	26 Jun 2000	expected ≥ 2006	123.5°E	Partial backup	S-VISSR, DCS, SEM
FY-2C Oct 2004	expected ≥ 2009	105°E	Operational	S-VISSR (improved), DCS, SEM
FY-2D	2006	expected ≥ 2011		Being built	S-VISSR (improved), DCS, SEM
FY-2E	2009	expected ≥ 2014		Planned	S-VISSR (improved), DCS, SEM
FY-2F	2011	expected ≥ 2015		Planned	S-VISSR (improved), DCS, SEM
FY-4A	2012	expected ≥ 2017		Being defined	Imager, sounder, lightning
FY-4B	2015	expected ≥ 2020		Being defined	MW radiometer



Fig. 2.6.1 – View of FY-2.

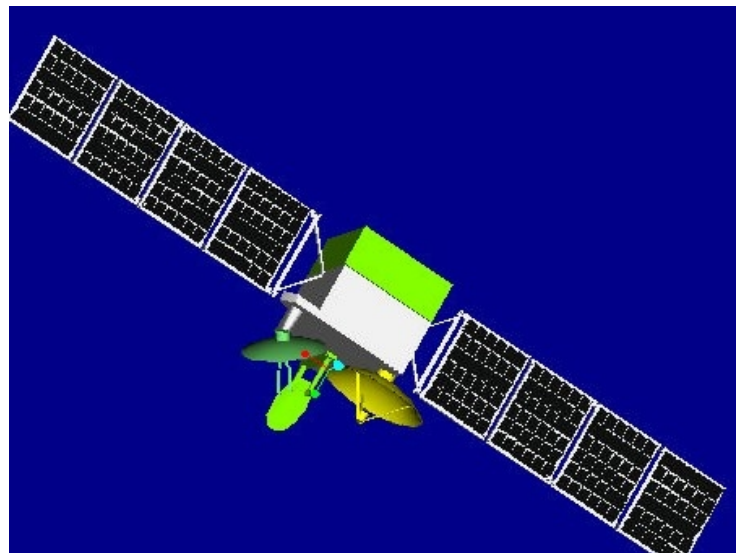

Fig. 2.6.2 – View of FY-4.

FY-2A

Launched in June 1997 on the 105°E position, was moved to 86.5°E in July 2000 to leave the operational service to FY-2B. It still has some capabilities that could be used in emergency.

FY-2B

Launched in June 2000, it exhibits now several operational limitation and serves as backup at 123.5°E.

FY-2C, 2D, 2E and 2F

FY-2C has been launched on **.... October 2004**, and will be followed by FY-2D (2006), FY-2E (2009) and FY-2F (2011). The payload has been improved in respect of that one of FY-2A and FY-2B.

Payload of FY-2

² *Feng-Yun* means “Wind and Cloud”. The “2” series is geostationary, the “1” and “3” series sunsynchronous.

- ***S-VISSR (Stretched Visible and Infrared Spin Scan Radiometer)*** – The version of FY-2A/B had three VIS/IR channels (0.5-1.05 μm , 6.3-7.6 μm and 10.5-12.5 μm) the improved version for FY-2 C/D/E splits the IR channel in two and adds a 3.5-4.0 μm channel. The resolution also is slightly improved: from 5.76 km (IR) and 1.44 km (VIS), to 5.0 km (IR) and 1.25 km (VIS). The image cycle is 30 min. See instrument sheet in Annex A3.1.

- **Data Collection Service (DCS)** - Main features:
 - uplink: two bands, frequencies 402.0-402.1 MHz for international DCPs (33 channels of bandwidth 3 kHz), 401.1-401.4 MHz for regional DCPs (100 channels of bandwidth 3 kHz); data rate 100 kbps, polarisation right-hand circular.
- **SEM (Space Environment Monitor).**

Data transmission from FY-2

FY-2 data are transmitted in real time to the:

- **Command and Data Acquisition Station (CDAS).** Main transmission characteristics:
 - frequency 1681.6 MHz, bandwidth 14 MHz, linear polarisation, data rate 14 Mbps.

Afterwards, data are re-transmitted to user stations. The broadcast will comply with the HRIT and LRIT standards and initially, with WEFAX for continuity reasons:

- **S-VISSR Data Transmission**, compatible with MDUS acquisition stations. Main features:
 - frequency: 1687.5 MHz; bandwidth: 2.0 MHz; polarisation: linear
 - antenna diameter ~ 3 m, G/T ~ 12 dB/K, data rate 660 kbps.
- **WEFAX** from FY-2 A/B, **LRIT (Low Rate Information Transmission)** from FY-2 C/D/E, similar to MSG, GOES, MTSAT and GOMS-N2. Main features of LRIT:
 - frequency: 1691.0 MHz; bandwidth: 260 kHz; polarisation: linear
 - antenna diameter ~ 1 m, G/T ~ 3 dB/K, data rate 150 kbps.

FY-4

A second generation geostationary series, **FY-4**, is being defined. It will be based on a 3-axis stabilised platform, with much improved payload in respect of FY-2. Currently, it is thought to have two types of missions:

- one (**FY-4A**) with an advanced VIS/IR imager, an IR sounding spectrometer and a lightning mapper; to be launched around 2012;
- one (**FY-4B**) with a MW radiometer for all-weather sounding and precipitation; to be launched around 2015.

2.7 The INSAT and Kalpana programmes

Although not part of the GOS, the *Indian National Satellite programme (INSAT)* supports national requirements and is coordinated within CGMS. It combines the meteorological mission with the function of supporting domestic telecommunications. It is a 3-axis stabilised satellite (*Fig. 2.7.1*), with generally two flight models in orbit, at 74°E and 93.5°E. Not all INSAT flight models carry a meteorological payload. In 2002 a small satellite entirely dedicated to meteorology, originally named *MetSat*, thereafter renamed *Kalpana*³, was launched over 74°E. *Table 2.7.1* records the chronology of the INSAT and Kalpana programmes.

Table 2.7.1 - Chronology of the INSAT and Kalpana programmes (in bold the satellites active in Sept 2005)

Satellite	Launch	End of service	Position	Status (Sept 2005)	Instruments
INSAT-1A	10 Apr 1982	6 Sep 1982		Inactive	VHRR, DCS
INSAT-1B	30 Aug 1983	Jul 1993		Inactive	VHRR, DCS
INSAT-1C	22 Jul 1988	Nov 1989		Inactive	VHRR, DCS
INSAT-1D	12 Jun 1990	May 2002		Inactive	VHRR, DCS
INSAT-2A	9 Jul 1992	30 May 2002		Inactive	VHRR, DCS
INSAT-2B	22 Jul 1993	2004		Inactive	VHRR, DCS
INSAT-2C	6 Dec 1995	April 2002		Inactive	No meteo
INSAT-2D	3 Jun 1997	4 Oct 1997		Inactive	No meteo
INSAT-2E	3 Apr 1999	expected ≥ 2006	83°E	Meteo not used	VHRR, CCD
INSAT-3A	10 Apr 2003	expected ≥ 2010	93.5°E	Operational	VHRR, CCD, DCS
INSAT-3B	22 mar 2000	expected ≥ 2008		Operational	No meteo
INSAT-3C	24 gen 2002	expected ≥ 2008		Operational	No meteo
INSAT-3D	2007	expected ≥ 2014	83°E	Being built	IMAGER, SOUNDER, DCS
Kalpana	12 set 2002	expected ≥ 2007	74°E	Operational	VHRR, DCS

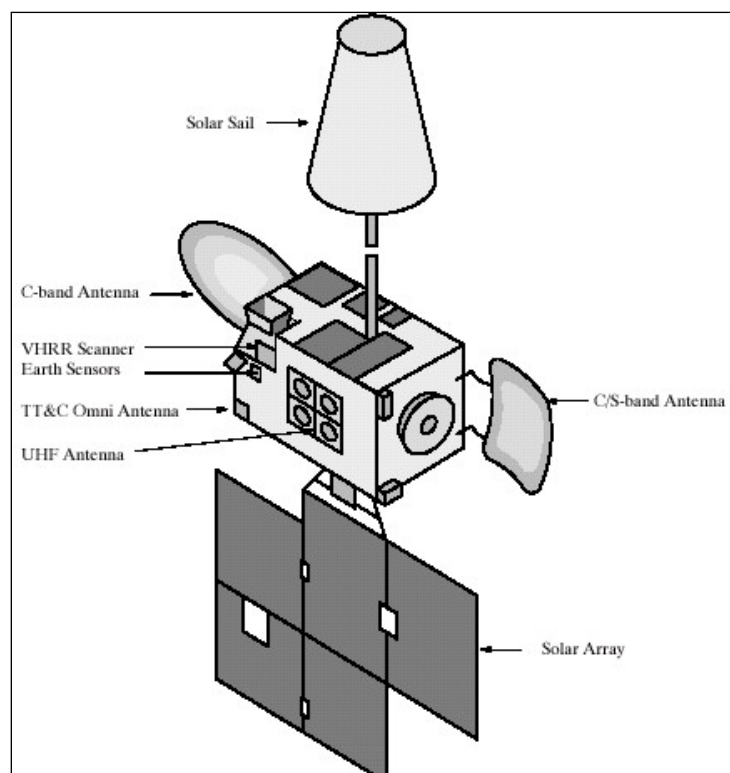

³ Kalpana was launched on 12 September 2002. **Fig. 2.7.1 – Sketch view of INSAT satellites.**

post with **Fig. 2.7.2 – View of Kalpana.** in

The series *INSAT-1*, used from 1982 to 2002, was carrying an imager, *VHRR*, derived by ATS-6 (see Table 2.3.1). It only had two VIS/IR channels (0.55-0.75 μm and 10.5-12.5 μm); resolution 11 km in IR, 2.75 km in VIS.

INSAT-2E and *3A*

INSAT 2E, launched in April 1999, is no longer being used for meteorological services. This satellite is located over 83°E. *INSAT-3A* is the operational satellite, on 93.5°E.

KALPANA

The Kalpana satellite was launched in September 2002 as a dedicated meteorological mission. It provides the operational service from 74°E.

Payload of INSAT and Kalpana satellites

- *VHRR (Very High Resolution Radiometer)* is a 3-channels VIS/IR radiometer with 8 km resolution in the two IR channels and 2 km in the VIS channel (only two channels on INSAT-1 and INSAT-2 A/B). The image cycle is three hours, but more frequent images are taken at intervals to generate trace-motion winds. See instrument sheet in Annex A3.1.
- On INSAT-2E and 3/A: *CCD Camera*, a TV camera with three VIS/NIR channels each at 1 km resolution, image cycle 3 hours, more frequent on demand. See instrument sheet in Annex A3.1.
- *Data Collection Service (DCS)* - Main features:
 - uplink: frequencies 402.65-402.85 MHz for international DCPs (8 channels of bandwidth 6 kHz), data rate 4.8 kbps, polarisation right-hand circular.

INSAT-3D

The traditional difficulty with INSAT usage was the need to share satellite resources with the (priority) telecommunication mission. *INSAT-3D*, instead, is being designed to be dedicated to meteorology. It will have imagery and sounding capabilities similar to those of the current GOES series:

- *IMAGER*, a 6-channels VIS/IR radiometer with 4.0 km resolution in 3 IR channels, 1.0 km in the VIS channel, 8 km in the water-vapour channels. Image cycle 30 min. See instrument sheet in Annex A3.1.
- *SOUNDER*, a 19-channel IR radiometer (including a VIS channels), 10 km resolution, Cycle 3 hours for 6000 km x 6000 km viewing area. See instrument sheet in Annex A3.1.

Data transmission from INSAT and Kalpana

INSAT and Kalpana data are first transmitted in real time to:

- *Command and Data Acquisition Station (CDAS)*: main transmission characteristics:
 - frequency MHz, bandwidth MHz, linear polarisation, data rate 0.526 Mbps.

After ground processing, data are provided to the users by:

- *Meteorological Data Distribution (MDD) Service*. Regular transmissions occur at 3-hour interval, with increased frequency during the cyclone season. Main features:
 - uplink: from the system central processing facility;
 - user terminals: frequency 2599.225 MHz, bandwidth 200 kHz, linear polarisation, antenna diameter ~ m, G/T ~ dB/K, base band 10 kHz (analogue)

With INSAT-3D, 2006, the system will be upgraded from current (analogue) to digital, following the HRIT and LRIT standards.

2.8 The COMS programme

The Korea Aerospace Research Institute (KARI) is developing *COMS (Communication, Oceanography and Meteorology Satellite)* for the Korea Meteorological Administration (KMA). It will be a multi-purpose satellite, 3-axis stabilised. *Table 2.8.1* records the planning details as known so far. *Fig. 2.8.1* provides an idea of the spacecraft structure

Table 2.8.1 - Chronology of the COMS programme

Satellite	Launch	End of service	Position	Status (Sept 2005)	Instruments
COMS-1	2008	expected \geq 2015	116°E	Being defined	Meteorological imager, Ocean sensor
COMS-2	2014	expected \geq 2021	116°E	Being defined	Meteorological imager, Ocean sensor

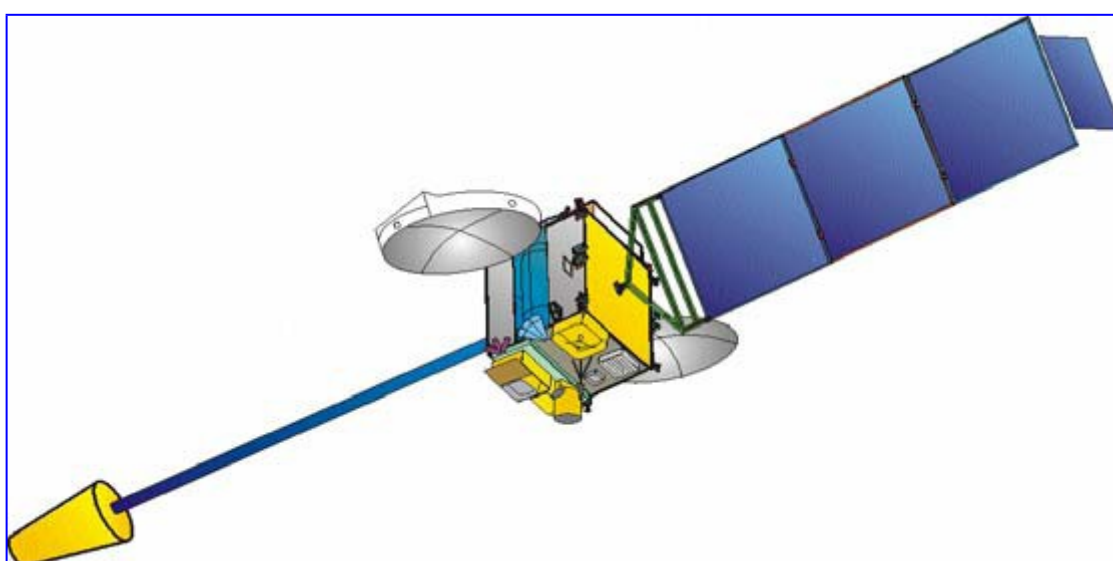

Fig. 2.8.1 - Sketch view of COMS

The *COMS payload* for Earth Observation includes:

- A *Meteorological Imager* with 10 channels in the range 0.6-13.7 μm , resolution 1 km in 3 VNIR channels, 4 km in 7 IR channels, 25 min for full disk imaging (proportionally less for limited areas). See instrument sheet in Annex A3.1.
- An *Ocean Sensor* with 8 narrow-band channels in the range 400-865 nm for ocean colour monitoring; resolution 500 m over a limited coverage (2500 km x 2500 km). See instrument sheet in Annex A3.1.

Data transmission from COMS

Raw data are transmitted to:

- the *Meteo/Ocean Data Application Center (MODAC)* and to the Satellite Operation Control Center:
 - frequency MHz, bandwidth MHz, linear polarisation, data rate Mbps.

After ground processing at MODAC, data are re-transmitted to the users by:

- **HRIT (High Rate Information Transmission)**. Main features:
 - frequency: \sim 1700 MHz; bandwidth: MHz; polarisation: linear
 - antenna diameter \sim m, G/T \sim dB/K, data rate Mbps;
- **LRIT (Low Rate Information Transmission)**, similar to MSG, GOES and MTSAT. Main features:
 - frequency: 1691.0 MHz; bandwidth: 200 kHz; polarisation: linear

- antenna diameter ~ m, G/T ~ ... dB/K, data rate kbps.

2.9 Coverage provided by geostationary satellites in 2005 and 2007

In this Section the compliance of the constellation of geostationary satellites with WMO requirements is evaluated. Since the requirement calls for six satellites equally spaced around the equator, *Table 2.9.1* identifies six sectors each one 60° wide. In addition, since two main satellites, Elektro-L and INSAT-3D, are planned for launch in 2007, the perspective situation in year 2007 is shown in *Table 2.8.2*. For 2007, the assumption has been made that INSAT-3D takes the current position of INSAT-2E (83°E) and GOES-10 replaces GOES-9 at 155°E.

Table 2.9.1 - Coverage from GEO as of Sept 2005 (CGMS XXXIII)

Geographic area	Satellite	Position	Status (Sept 2005)	Main instruments
30°W - 30°E Europe, Africa, Eastern Atlantic	Meteosat-8	3.6°W	Operational	SEVIRI, GERB
	Meteosat-7	0°	Redundant (for transition)	MVIRI
	Meteosat-6	9.3°E	Backup + Rapid scan	MVIRI
30°E - 90°E Western Asia, Indian Ocean	Meteosat-5	63°E	Operational	MVIRI
	Kalpana	74°E	Operational	VHRR
	FY-2A	86.5°E	Partial backup	S-VISSR
90°E - 150°E East-Asia, Australia, West- Pacific	INSAT-3A	93.5°E	Operational	VHRR, CCD
	FY-2C	105°E	Operational	S-VISSR
	FY-2B	123.5°E	Partial backup	S-VISSR
150°E - 150°W Oceania, Central Pacific	MTSAT-1R	140°E	Operational	JAMI
	GOES-9	155°E	Operational (with limitation)	IMAGER, SOUNDER
150°W - 90°W East-Pacific, North-West America	GOES-10	135°W	Operational	IMAGER, SOUNDER
	GOES-11	105°W	Standby	IMAGER, SOUNDER
90°W - 30°W South America, NE America, West Atlantic	GOES-12	75°W	Operational	IMAGER, SOUNDER

Table 2.9.2 - Coverage from GEO as expected for 2007 (CGMS XXXI)

Geographic area	Satellite	Position	Expected status in 2007	Main instruments
30°W - 30°E Europe, Africa, Eastern Atlantic	Meteosat-9	0°	Operational	SEVIRI, GERB
	Meteosat-8	~ 0°	Hot standby	SEVIRI, GERB
	Meteosat-7	~ 0°	Redundant (for transition)	MVIRI
	Meteosat-6	~ 0°	Backup + Rapid scan	MVIRI
30°E - 90°E Western Asia, Indian Ocean	Kalpana	74°E	Backup	VHRR
	Elektro-L-1	76°E	Operational	MSU-GS
	INSAT-3D	83°E	Operational	IMAGER, SOUNDER
90°E - 150°E East-Asia, Australia, West- Pacific	INSAT-3A	93.5°E	Backup	VHRR, CCD
	FY-2C	105°E	Operational	S-VISSR
	MTSAT-1	140°E	Operational	JAMI
	MTSAT-2	~ 140°E	Hot standby	IMAGER
150°E - 150°W Oceania, Central Pacific	GOES-10	155°E	Operational	IMAGER, SOUNDER
150°W - 90°W East-Pacific, North-West America	GOES-11	135°W	Operational	IMAGER, SOUNDER
	GOES-13	105°W	Hot standby	IMAGER, SOUNDER
90°W - 30°W	GOES-12	75°W	Operational	IMAGER,

South America, NE America, West Atlantic				SOUNDER
------------------------------------------	--	--	--	----------------

Table 2.9.3 shows the distribution of gaps of coverage in respect of the required $\pm 55^\circ$ latitude. The gaps in respect of the requirement are highlighted in grey. There is a gap around 0° that is only apparent, since EUMETSAT has several backup satellites in the area (see Tables 2.9.1 and 2.9.2). The other gap is over Oceania and Central Pacific, but can easily be filled by moving GOES-9 (2005) or GOES 10 (2007) eastward.

Table 2.9.3 – Latitudinal coverage at Sept 2005 and expected for 2007 (highlighted if $< 55^\circ$)

2005	GOES-10	GOES-12	Meteosat-8	Meteosat-5	Kalpana	INSAT-3A	FY-2C	MTSAT-1R	GOES-9	GOES-10
S.S.P.	135°W	75°W	3.6°W	63°E	74°E	93.5°E	105°E	140°E	155°E	135°W
Δ SSP	60°	71.4°	66.6°	11°	19.5°	11.5°	35°	15°	70°	
Latitude cover	$\pm 55^\circ$	$\pm 52^\circ$	$\pm 53^\circ$	$\pm 60^\circ$	$\pm 60^\circ$	$\pm 60^\circ$	$\pm 59^\circ$	$\pm 60^\circ$	$\pm 52^\circ$	
2007	GOES-11	GOES-12	Meteosat-9	Elektro-L-1	INSAT-3D	FY-2C	MTSAT-1R	GOES-10	GOES-11	
S.S.P.	135°W	75°W	0°	76°E	83°E	105°E	140°E	155°E	135°W	
Δ SSP	60°	75°	76°	7°	22°	35°	15°	70°		
Latitude cover	$\pm 55^\circ$	$\pm 51^\circ$	$\pm 50^\circ$	$\pm 60^\circ$	$\pm 60^\circ$	$\pm 59^\circ$	$\pm 60^\circ$	$\pm 52^\circ$		

Fig. 2.9.1 and **Fig. 2.9.2** show the composite coverage from the operational satellites in September 2005 and in 2007, respectively (in bold in Tables 2.9.1 and 2.9.2). The figures should be compared with the WMO requirement shown in Fig. 1.1. It can be noted that, from a “mechanical” viewpoint, i.e. independent on data quality (the subject of section 2.10, next), the coverage situation, though not optimal, is and will remain satisfactory. Also, there is enough built-in contingency to keep the system operational under most circumstances.

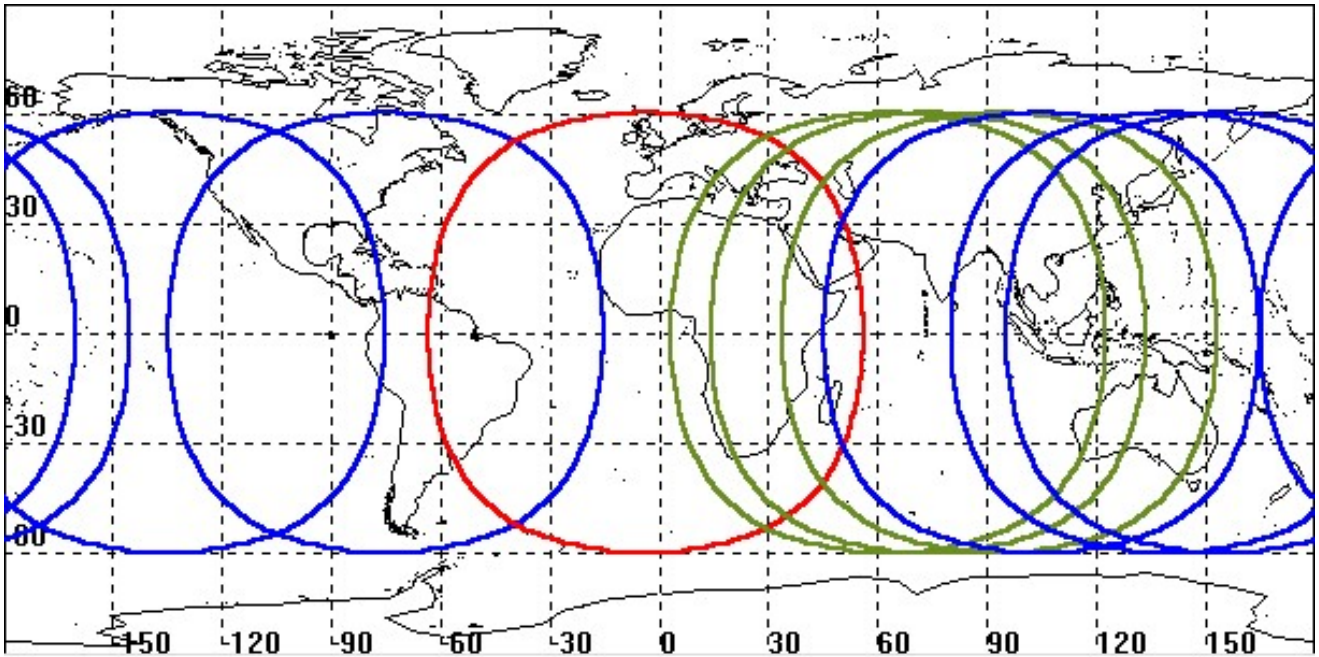

Fig. 2.9.1 – Coverage from operational geostationary satellites as of September 2005. Satellites: GOES-10 (135°W), GOES-12 (75°W), Meteosat-8 (3.6°W), Meteosat-5 (63°E), Kalpana (74°E), INSAT-3A (93.5°E), FY-2C (105°E), MTSAT-1R (140°E) and GOES-9 (155°E). Red: advanced imagers (Meteosat-8 SEVIRI); blue: 5 channel imagers (GOES-9/10/12 IMAGER, FY-2C S-VISSR, MTSAT-1R JAMI); green: 3 channel imagers (Meteosat-5 MVIRI, INSAT-3A VHRR and CCD, Kalpana VHRR).

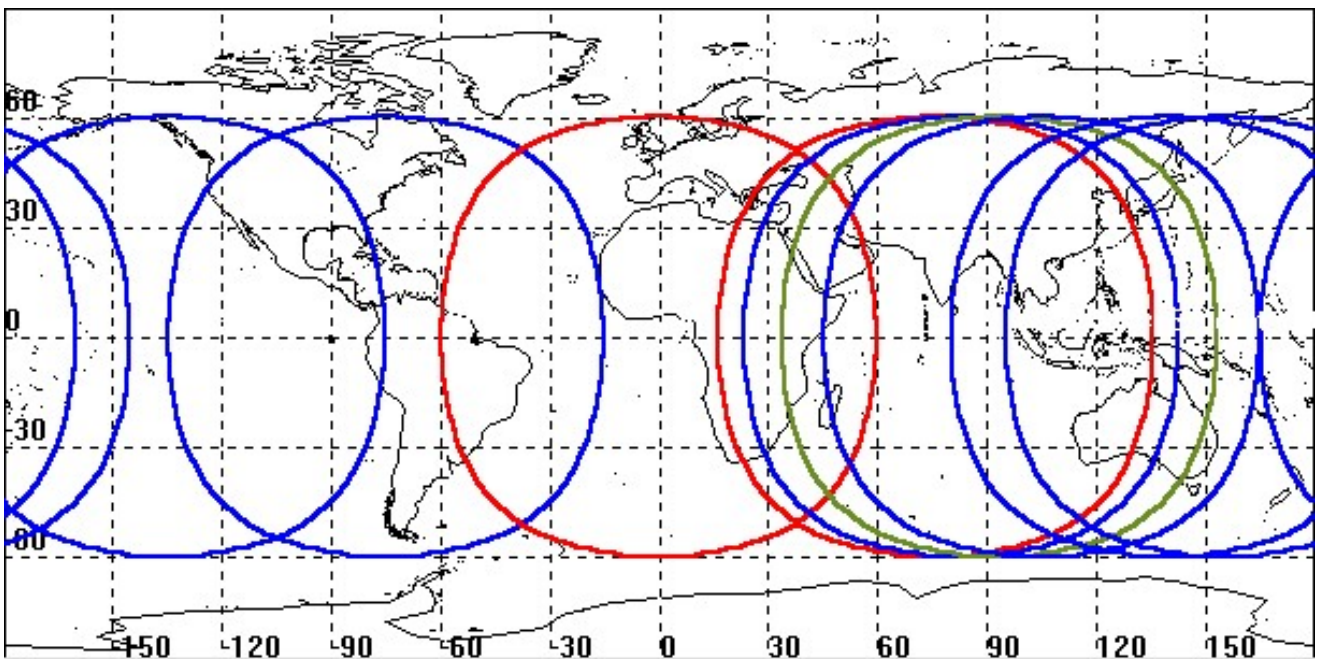

Fig. 2.9.2 – Coverage from operational geostationary satellites as expected in 2007. Satellites: GOES-11 (135°W), GOES-12 (75°W), Meteosat-9 (0°), Elektro-L-1 (76°E), INSAT-3D (83°E), FY-2C (105°E), MTSAT-1R (140°E) and GOES-10 (155°E). Red: advanced imagers (Meteosat-9 SEVIRI, Elektro-L-1 (MSU-GS)); blue: 5-6 channel imagers (GOES 10/11/12 IMAGER, INSAT-3D IMAGER, FY-2C S-VISSR, MTSAT-1 JAMI).

2.10 Comparative instrument performances

In addition to the coverage, the system also must provide homogeneous performances in terms of data quality, that depends on the instruments. *Table 2.10.1* compares the main features of imagers being operational in September 2005, *Table 2.10.2* refers instead to what is expected in year 2007.

Table 2.10.1 - Main features of imagers on-board GEO satellites in Sept 2005

Meteosat-8 SEVIRI (*)	Meteosat-5 MVIRI	GOES-9/10 IMAGER	GOES-12 IMAGER	FY-2C S-VISSR	INSAT-3A VHRR + CCD	MTSAT-1R JAMI	Kalpana VHRR
12.4-14.4 μm			13.0-13.7 μm				
11.0-13.0 μm		11.5-12.5 μm		11.5-12.5 μm		11.5-12.5 μm	
9.80-11.8 μm	10.5-12.5 μm	10.2-11.2 μm	10.2-11.2 μm	10.3-11.3 μm	10.5-12.5 μm	10.3-11.3 μm	10.5-12.5 μm
9.38-9.94 μm							
8.30-9.10 μm							
6.85-7.85 μm							
5.35-7.15 μm	5.70-7.10 μm	6.50-7.00 μm	5.80-7.30 μm	6.30-7.60 μm	5.70-7.10 μm	6.50-7.00 μm	5.70-7.10 μm
3.40-4.20 μm		3.80-4.00 μm	3.80-4.00 μm	3.50-4.00 μm		3.50-4.00 μm	
1.50-1.78 μm					1.55-1.70 μm		
0.74-0.88 μm					0.77-0.86 μm		
0.56-0.71 μm	0.50-0.90 μm	0.55-0.75 μm	0.55-0.75 μm	0.55-0.99 μm	0.55-0.75 μm	0.55-0.90 μm	0.55-0.75 μm
0.60-0.90 μm					0.63-0.79 μm		
15 min	15 min	30 min	30 min	30 min	180 min	60 min	3 hours
VIS/IR 3.0 km HRVIS 1.0 km	VIS/IR 5.0 km HRVIS 2.5 km	IR 4.0 km VIS 1.0 km	IR 4.0 km VIS 1.0 km	IR 5.76 km VIS 1.44 km	IR 8.0 km VIS 2.0 km CCD 1.0 km	IR 4.0 km VIS 1.0 km	IR 8.0 km VIS 2.0 km

(*) SEVIRI channels are defined as 99 % of encircled energy instead of half-power-width.

Table 2.9.2 - Main features of imagers on-board GEO satellites expected for 2007

Meteosat-9 SEVIRI (*)	GOES-10/11 IMAGER	GOES-12 IMAGER	MTSAT-1 JAMI	Elektro-L-1 MSU-GS	FY-2C S-VISSR	INSAT-3D IMAGER	Kalpana-2 VHRR
12.4-14.4 μm		13.0-13.7 μm					
11.0-13.0 μm	11.5-12.5 μm		11.5-12.5 μm	11.2-12.5 μm	11.5-12.5 μm	11.5-12.5 μm	
9.80-11.8 μm	10.2-11.2 μm	10.2-11.2 μm	10.3-11.3 μm	10.2-11.2 μm	10.3-11.3 μm	10.2-11.2 μm	10.5-12.5 μm
9.38-9.94 μm				9.20-10.2 μm			
8.30-9.10 μm				8.20-9.20 μm			
6.85-7.85 μm				7.50-8.50 μm			
5.35-7.15 μm	6.50-7.00 μm	5.80-7.30 μm	6.50-7.00 μm	5.70-7.00 μm	6.30-7.60 μm	6.50-7.00 μm	5.70-7.10 μm
3.40-4.20 μm	3.80-4.00 μm	3.80-4.00 μm	3.50-4.00 μm	3.50-4.00 μm	3.50-4.00 μm	3.80-4.00 μm	
1.50-1.78 μm						1.55-1.70 μm	

μm							
0.74-0.88 μm				0.80-0.90 μm			
0.56-0.71 μm	0.55-0.75 μm	0.55-0.75 μm	0.55-0.90 μm	0.65-0.80 μm	0.55-0.99 μm	0.52-0.72 μm	0.55-0.75 μm
0.60-0.90 μm				0.50-0.65 μm			
15 min	30 min	30 min	60 min	30 min	30 min	30 min	3 hours
VIS/IR 3.0 km HRVIS 1.0 km	IR 4.0 km VIS 1.0 km	IR 4.0 km VIS 1.0 km	IR 4.0 km VIS 1.0 km	IR 4.0 km VIS/NIR 1.0km	IR 5.0 km VIS 1.25 km	IR 4km,WV 8km VIS/NIR 1.0km	IR 8.0 km VIS 2.0 km

(*) SEVIRI channels are defined as 99 % of encircled energy instead of half-power-width.

Three categories of instruments can be identified:

- with 3 channels: Meteosat-5 MVIRI, Kalpana VHRR, INSAT-3A VHRR, INSAT-3-A CCD;
- 5-6 channels: GOES-12 IMAGER, MTSAT-1R JAMI, FY-2C S-VISSR, INSAT-3D IMAGER;
- advanced imagers with pseudo-sounding capability: Meteosat-8/9 SEVIRI, Elektro-L-1 MSU-GS.

In Fig. 2.9.1 and Fig. 2.9.2 the coverage from images of different classes is highlighted by different colours. It is noted that in September 2005 there is lack of quality in Central Asia / Indian Ocean, whereas in 2007 this gap will be filled.

3. Sunsynchronous meteorological satellites

3.1 Generalities

At the time of the First GARP Global Experiment (FGGE, 1979-80) the WMO requirement for sunsynchronous satellites was two satellites with orthogonal orbital planes. For large-swath instruments with day and night capability this would ensure global coverage at 6-hour intervals. In the 90's, the EUMETSAT and NOAA agreement for a Joint Polar System (JPS) was aiming at three satellites with orbital planes de-phased by 60° so as to achieve global coverage at 4-hour intervals. In 2002 the WMO requirement has been increased to four satellites, two in morning orbits and two in afternoon orbits, so as to provide global coverage at 3-hour intervals in average, and also to ensure that sufficient contingency margins exist in case one of the satellites experiences degraded performance, waiting for the replacement.

The mission of sunsynchronous satellites is, as a minimum:

- to provide temperature and humidity global sounding for the purpose of NWP;
- to provide imagery mission to high latitudes inaccessible to geostationary satellites.

Several satellites provide more than this. Some provide observation of ozone and other trace gases, some exploit microwave radiometry for precipitation observation, some carry active microwave instruments (radar) for, e.g., sea-surface wind observation, etceteras. In addition, several products are derived by image processing, specifically surface parameters. Imaging and sounding instruments are in continuous upgrading process, generally under the aspects of number of channels (imagers) and spectral resolution (sounders). As for further upgrading to be pursued within the operational context, it is reminded that the “*Implementation Plan for Evolution of Space and Surface-based Sub-systems of the GOS*” developed by the CBS Open Programme Area Group on the Integrated Observing Systems (OPAG-IOS) (WMO/TD No. 1267 dated April 2005), as concerns future polar satellites has recommended the following:

- *LEO Sea Surface Wind - Sea-surface wind data from R&D satellites should continue to be made available for operational use; 6-hourly coverage is required. In the NPOESS and Metop era, sea surface wind should be observed in a fully operational framework. Therefore it is urgent to assess whether the multi-polarisation passive MW radiometry is competitive with scatterometry.*
- *LEO Altimeter - Missions for ocean topography should become an integral part of the operational system.*
- *LEO Earth Radiation Budget - Continuity of ERB-type global measurements for climate records requires immediate planning to maintain broad-band radiometers on at least one LEO satellite.*

In addition, OPAG-IOS indicated missions to be prepared by R&D satellites before considering their adoption into an operational framework. These recommendation are recorded in Section 4.1 to follow.

3.2 The NOAA/POES programme

The American *POES (Polar-orbiting Operational Environmental Satellite)*, when considering the precursor series TIROS, ESSA and ITOS, is the most long-standing meteorological satellite programme (first launch: 1° April 1960). It evolved through the following phases.

- 1st generation – Ten satellites *TIROS (Television and Infra-Red Observation Satellite)*, spin-stabilised (**Fig. 3.2.1**), to experience orbits, instruments and communication systems. Instruments:
 - VCS (Vidicon Camera System) with Narrow-Angle (NA) and high resolution (0.25 km), Medium-Angle (MA) and resolution (1.6 km), Wide-Angle (WA) and low resolution (2.4 km);
 - APT (Automatic Picture Transmission), resolution 1.8 km;
 - MRIR (Medium Resolution Infrared Radiometer) and FPR (Flat Plate Radiometer)
- 2nd generation – Nine satellites *ESSA (Environmental Science and Services Administration)*, two in orbit at any time (*TOS, TIROS Operational System*) for image broadcasting either in real time (ESSA-2/4/6/8) or after on-board storage (ESSA-1/3/5/7/9). They were spin-stabilised in a “cartwheel” mode so as to be able to point the camera towards Earth (**Fig. 3.2.2**). Instruments:
 - on ESSA-2/4/6/8: APT (Automatic Picture Transmission), resolution 3.7 km;
 - on ESSA-1/3/5/7/9: AVCS (Advanced Vidicon Camera System), resolution 3.7 km, and FPR.
- 3rd generation – Six satellites *ITOS (Improved TOS)*, the first named TIROS-M or ITOS-1, the other ones *NOAA (National Oceanic and Atmospheric Administration)* (**Fig. 3.2.3**). They introduced IR imagery and temperature sounding. 3-axis stabilised. Instruments:
 - SR (Scanning Radiometer): 0.55-0.75 μm , resolution 3.6 km, and 10.5-12.5 μm , 7.2 km;
 - VHRR (Very High Resolution Radiometer): same channels as SR but with resolution 0.9 km;
 - VTPR (Vertical Temperature Profile Radiometer): 8 channels, 11 to 20 μm , resolution 55 km;
 - SPM (Solar Proton Monitor) and FPR;
- 4th generation – Ten operational satellites, the first named TIROS-N, the following nine *NOAA* from 6 to 14, with an improvement (*ATN, Advanced TIROS-N*) starting from NOAA-8. Two satellites in orbit at any time, with LST (Local Solar Time) at 7.30 and 14.00. 3-axis-stabilised. Instruments:
 - AVHRR (Advanced VHRR): see next
 - HIRS/2 (High-resolution Infra Red Sounder): see next
 - MSU (Microwave Sounding Unit): 4 channels from 50 to 58 GHz, resolution 110 km
 - SSU (Stratospheric Sounding Unit): three channels around 14.95 μm , resolution 150 km
 - SBUV/2 (Solar Backscatter Ultraviolet): see next
 - ERBE (Earth Radiation Budget Experiment): only on NOAA-9 and NOAA-10
 - SEM (Space Environment Monitor), SARSAT (Search and Rescue Satellite Aided Tracking System), ARGOS/DCS (ARGOS Data Collection System); see next.
- 5th generation, the current one, now called *POES (Polar-orbiting Operational Environmental Satellite)*, started in 1998 with NOAA-15, to be used until around 2012 by five flight models (NOAA-K/L/M/N/N'). POES satellites (**Fig. 3.2.4**) still use the 3-axis stabilised ATN platform and are in orbit two at any time, at LST 7.30 and 14.00. The difference between the 4th and 5th generations consists of the improvement of the instrumentation for MW atmospheric sounding.

Table 3.2.1 records the chronology of NOAA and precursor satellites. For sunsynchronous satellites (starting with TIROS-9) the LST is provided, for previous the orbital inclination. Morning LSTs are defined at the equatorial descending node, afternoon at the ascending node.

At the end of 2005, the two nominal operational satellites are NOAA-17 and NOAA-18, with NOAA-15 and NOAA-16 still sufficiently efficient as to act as backup. NOAA-12 and NOAA-14 still have some functionalities (NOAA-12: AVHRR, SEM and Argos; NOAA-14, the last satellite of the 4th generation, still has HIRS/2, SSU, SEM, Argos and SARSAT operable).

Table 3.2.1 – Chronology of the NOAA/POES programme (in bold the satellites active in Sept 2005)

Satellite	Launch	End of service	Height	LST or inclin.	Status (Sept 2005)	Instruments
TIROS-1	1 Apr 1960	17 Jun 1960	720 km	48.4°	Inactive	VCS-WA, VCS-NA
TIROS-2	23 Nov 1960	24 Dec 1961	670 km	48.6°	Inactive	VCS-WA, VCS-NA, MRIR, FPR
TIROS-3	12 Jul 1961	27 Feb 1962	780 km	47.9°	Inactive	2 x VCS-WA, MRIR, FPR
TIROS-4	8 Feb 1962	19 Jul 1962	770 km	48.3°	Inactive	VCS-WA, VCS-MA, MRIR, FPR
TIROS-5	19 Jun 1962	27 Nov 1963	750 km	58.1°	Inactive	VCS-WA, VCS-MA
TIROS-6	18 Sep 1962	12 Oct 1963	700 km	58.3°	Inactive	VCS-WA, VCS-MA
TIROS-7	19 Jun 1963	3 Jun 1968	680 km	58.2°	Inactive	2 x VCS-WA, MRIR, FPR
TIROS-8	21 Dec 1963	1 Jul 1967	730 km	58.5°	Inactive	APT, VCS-WA
TIROS-9	22 Jan 1965	12 Jun 1968	1350 km	9.30	Inactive	2 x VCS-WA (“cartwheel”)
TIROS-10	2 Jul 1965	1 Jul 1967	790 km	9.30	Inactive	2 x VCS-WA
ESSA-1	3 Feb 1966	8 Mar 1967	770 km	9.30	Inactive	2 x VCS-WA, FPR
ESSA-2	28 Feb 1966	16 Oct 1970	1390 km	9.30	Inactive	2 x APT
ESSA-3	2 Oct 1966	2 Dec 1968	1440 km	9.30	Inactive	2 x AVCS, FPR
ESSA-4	26 Jan 1967	5 May 1968	1380 km	9.30	Inactive	2 x APT
ESSA-5	20 Apr 1967	20 Feb 1970	1390 km	9.30	Inactive	2 x AVCS, FPR
ESSA-6	10 Nov 1967	3 Dec 1969	1450 km	9.30	Inactive	2 x APT
ESSA-7	16 Aug 1968	10 Mar 1970	1450 km	9.30	Inactive	2 x AVCS, 2 x FPR
ESSA-8	15 Dec 1968	12 Mar 1976	1440 km	9.30	Inactive	2 x APT
ESSA-9	26 Feb 1969	15 Nov 1972	1470 km	9.30	Inactive	2 x AVCS, 2 x FPR
ITOS-1 (TIROS-M)	23 Jan 1970	18 Jun 1971	1470 km	14.30	Inactive	2 x AVCS, 2 x APT, 2 x SR, FPR, SPM
NOAA-1 (ITOS-A)	11 Dec 1970	19 Aug 1971	1450 km	13.30	Inactive	2 x AVCS, 2 x APT, 2 x SR, FPR, SPM
NOAA-2 (ITOS-D)	13 Oct 1972	30 Jan 1975	1450 km	14.30	Inactive	2 x VHRR, 2 x SR, 2 x VTPR, SPM
NOAA-3 (ITOS-F)	6 Nov 1973	31 Aug 1976	1500 km	14.30	Inactive	2 x VHRR, 2 x SR, 2 x VTPR, SPM
NOAA-4 (ITOS-G)	15 Nov 1974	18 Nov 1978	1450 km	14.30	Inactive	2 x VHRR, 2 x SR, 2 x VTPR, SPM
NOAA-5 (ITOS-H)	29 Jul 1976	16 Jul 1979	1510 km	14.30	Inactive	2 x VHRR, 2 x SR, 2 x VTPR, SPM
TIROS-N	13 Oct 1978	27 Feb 1981	850 km	14.30	Inactive	AVHRR, HIRS/2, MSU, SSU, SEM, Argos
NOAA-6	27 Jun 1979	31 Mar 1987	840 km	07.30	Inactive	AVHRR, HIRS/2, MSU, SSU, SEM, Argos
NOAA-7	23 Jun	7 Jun	860 km	14.30	Inactive	AVHRR, HIRS/2, MSU, SSU,

	1981	1986				SEM, Argos
NOAA-8	28 Mar 1983	29 Dec 1985	820 km	07.30	Inactive	AVHRR, HIRS/2, MSU, SSU, SEM, Argos, SARSAT
NOAA-9	12 Dec 1984	13 Feb 1998	850 km	14.30	Inactive	AVHRR, HIRS/2, MSU, SSU, SEM, Argos, SARSAT, ERBE, SBUV/2
NOAA-10	17 Sep 1986	30 Aug 2001	810 km	07.30	Inactive	AVHRR, HIRS/2, MSU, SSU, SEM, Argos, SARSAT, ERBE, SBUV/2
NOAA-11	24 Sep 1988	6 Nov 2004	843 km	14.15	Inactive	AVHRR, HIRS/2, MSU, SSU, SEM, Argos, SARSAT, SBUV/2
NOAA-12	14 May 1991	expected ≥ 2005	808 km	04.40	Limited use	AVHRR, HIRS/2, MSU, SSU, SEM, Argos
NOAA-13	9 Aug 1993	21 Aug 1993	820 km	14.00	Inactive	AVHRR, HIRS/2, MSU, SSU, SEM, Argos, SARSAT, SBUV/2
NOAA-14	30 Dec 1994	expected ≥ 2005	847 km	07.40	Limited use	AVHRR/2, HIRS/2, MSU, SSU, SEM, Argos, SARSAT, SBUV/2
NOAA-15	13 May 1998	expected ≥ 2005	807 km	06.00	Backup	AVHRR/3, HIRS/3, AMSU-A, AMSU-B, SEM/2, Argos, SARSAT
NOAA-16	21 Sep 2000	expected ≥ 2006	849 km	14.54	Backup	AVHRR/3, HIRS/3, AMSU-A, AMSU-B, SBUV/2, SEM/2, Argos, SARSAT
NOAA-17	24 Jun 2002	expected ≥ 2009	810 km	10.24	Operational	AVHRR/3, HIRS/3, AMSU-A, AMSU-B, SBUV/2, SEM/2, Argos, SARSAT
NOAA-18	20 May 2005	expected ≥ 2010	854 km	13.54	Operational	AVHRR/3, HIRS/3, AMSU-A, MHS, SBUV/2, SEM/2, Argos, SARSAT
NOAA-19 (NOAA-N')	2007	expected ≥ 2011	840 km	14.00	Being built	AVHRR/3, HIRS/3, AMSU-A, MHS, SBUV/2, SEM/2, Argos, SARSAT

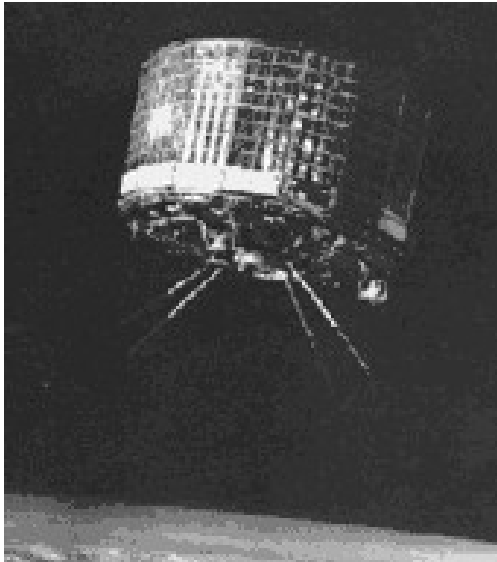

**Fig. 3.2.1 – View of TIROS
(spin-stabilised).**

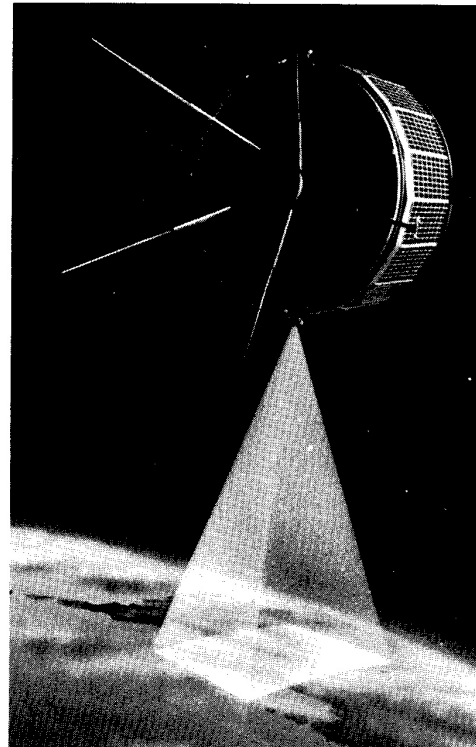

**Fig. 3.2.1 – View of ESSA
("cartwheel" spin-**

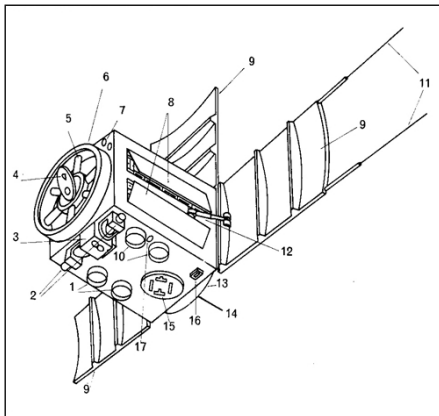

**Fig. 3.2.3 – Sketch view of ITOS
(first**

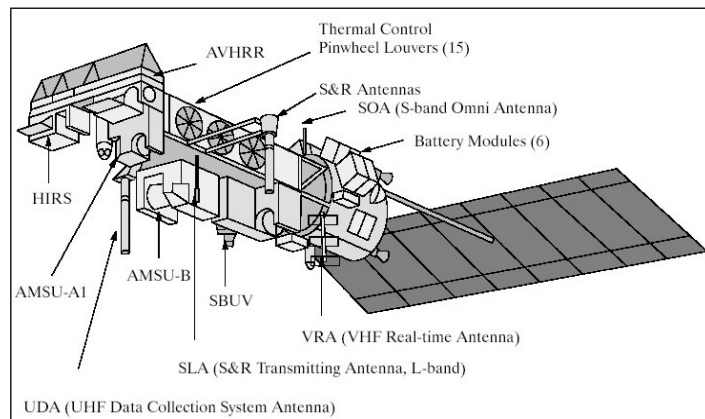

Fig. 3.2.4 – Sketch view of NOAA (K, L, M series).

NOAA-15

Launched in May 1998, it is the first satellite of the 5th generation, that replaces the sounding package TOVS (TIROS Operational Vertical Sounding = HIRS/2 + MSU + SSU), by *ATOVS (Advanced TOVS = HIRS/3 + AMSU-A + AMSU-B)*. Some instruments currently are defective, but still NOAA-15 could backup NOAA-17 in case of problems.

NOAA-16

Launched in September 2000, it is the current operational satellite in the afternoon orbit. Unfortunately, its VHF transmitter for APT has failed.

NOAA-17

Launched in June 2002, it is the last NOAA satellite in the morning orbit.

NOAA-18

Launched in May 2005, it is the first of the two last satellites (NOAA-N and NOAA-N'), on which AMSU-B is replaced by the EUMETSAT-provided MHS.

Payload of the 5th generation NOAA satellites (NOAA-15 onwards)

- ***AVHRR/3 (Advanced VHRR)***: 6-channel VIS/IR radiometer for multi-purpose imagery with 1.1 km resolution and 2900 km swath. Only 5 channels transmitted (1.6 μm and 3.7 μm are alternative, day and night respectively). See instrument sheet in Annex A3.1.
- ***HIRS/3 (High-resolution Infra Red Sounder - 3)***: 20-channels IR radiometer (including one VIS) for temperature/humidity sounding, resolution 18 km and swath 2250 km. See instrument sheet in Annex A3.1.
- ***AMSU-A (Microwave Sounding Unit - A)***: 15-channel MW radiometer for nearly-all-weather temperature sounding, resolution 48 km, swath 2250 km. See instrument sheet in Annex A3.1.
- ***AMSU-B (Microwave Sounding Unit - B)***: 5-channel MW radiometer for nearly-all-weather humidity sounding, resolution 16 km, swath 2250 km. To be replaced on NOAA-N and NOAA-N' by ***MHS (Microwave Humidity Sounder)***. See instrument sheet in Annex A3.1.
- ***SBUV/2 (Solar Backscatter Ultraviolet - 2)***: 12-channel UV spectro-radiometer for ozone profiling, resolution 170 km, nadir-only viewing. See instrument sheet in Annex A3.1.
- ***SEM/2 (Space Environment Monitor)***, an instrument suite for *in situ* measurement of the energy of charged particle of the solar wind at orbital height (not on NOAA-15).
- ***DCS/2 (Data Collection System – 2)***, also know as ***Argos***, to collect data from automatic stations and localise the platform. Platform transmission frequency: 401.65 MHz.
- ***SARSAT (Search and Rescue Satellite Aided Tracking System)***, location system for emergency calls from transmitters at 121.5 or 243 or 406 MHz.

Data transmission from NOAA satellites

The totality of the information from NOAA instruments is transmitted in real time, and only part is stored on board for successive transmission to:

- ***Command and Data Acquisition stations (CDA)*** in charge of global data recovery. Main features:
 - frequencies: 1702.5 MHz (left-hand circular polarisation) and 1698 or 1707 MHz (right-hand circular polarisation); bandwidth MHz, data rate 2.66 Mbps;
 - GAC (Global Area Coverage) all data from low-bit-rate instruments at full resolution and AVHRR images with resolution reduced to 4 km, for the full orbit (102 min);
 - LAC (Local Area Coverage) for up to 11 min of selected AVHRR full resolution image frames.

There are three types of transmission with different contents for different ground receiving stations.

- ***HRPT (High Resolution Picture Transmission)***, for the whole information at full resolution in digital form at S-band frequencies. Main features:
 - frequencies: 1698 or 1707 MHz; bandwidth: 2.66 MHz; polarisation: right hand circular (backup: 1702.5 MHz, polarisation left hand circular)
 - antenna diameter ~ 2 m, G/T ~ 6.0 dB/K, data rate 665.4 kbps;
- ***APT (Automatic Picture Transmission)***, for two image channels at reduced resolution (4 km) with correction of the panoramic distortion, in analogue form at VHF frequencies. Main features:
 - frequencies: 137.5 or 137.62 MHz; bandwidth: 34 kHz; polarisation: right hand circular
 - omni-directional antenna, G/T ~ -30 dB/K, base band 2.1 kHz (analogue);
- ***DSB (Direct Sounder Broadcast)***, for low-bit instruments (but not AMSU), in digital form at VHF frequencies. Main features:
 - frequencies: 137.35 or 137.77 MHz; bandwidth: kHz; polarisation: right hand circular
 - antenna:, G/T \sim dB/K, data rate 8.32 kbps.

3.3 The DMSP programme (limited to MW sensors supportive of GOS)

Strictly speaking, the *DMSP (Defense Meteorological Satellite Program)* is not part of the GOS, but data from the Special Sensors in Microwave (SSM) are distributed from NOAA either to make up for the lack of MW imagers on NOAA satellites, or as a backup to the MW temperature/humidity sounders.

DMSP is a 3-axis stabilised satellite using the same platform as current NOAA satellites (see again Fig. 3.2.4). The DoD (Department of Defense) uses to have two satellites in orbit at any time, with LST 5.30 and 7.30 respectively. *Table 3.3.1* records the chronology of the DMSP limited to the period since the introduction of the SSM instruments.

Table 3.3.1 – Chronology of the DMSP/SSM programme (in bold the satellites active in Sept 2005)

Satellite	Launch	End of service	Height	LST	Status (Sept 2005)	MW instruments
DMSP-F04	6 Jun 1979	29 Aug 1980	850 km	????	Inactive	SSM/T
DMSP-F07	18 Dec 1983	17 Oct 1987	850 km	????	Inactive	SSM/T
DMSP-F08	18 Jun 1987	13 Aug 1991	850 km	06.05	Inactive	SSM/I, SSM/T
DMSP-F09	3 Feb 1988	????	850 km	????	Inactive	SSM/T
DMSP-F10	1 Dec 1990	14 Nov 1997	850 km	10.20	Inactive	SSM/I, SSM/T
DMSP-F11	28 Nov 1991	16 May 2000	850 km	07.30	Inactive	SSM/I, SSM/T, SSM/T-2
DMSP-F12	29 Aug 1994	31 Jul 2002	850 km	05.45	Inactive	SSM/T, SSM/T-2
DMSP-F13	24 Mar 1995	expected ≥ 2005	850 km	06.25	Operational	SSM/I, SSM/T
DMSP-F14	4 Apr 1997	expected ≥ 2005	852 km	07.40	Backup	SSM/I, SSM/T, SSM/T-2
DMSP-F15	12 Dec 1999	expected ≥ 2006	850 km	09.15	Operational	SSM/I, SSM/T, SSM/T-2
DMSP-F16	18 Oct 2003	expected ≥ 2008	833 km	08.00	Operational	SSMIS
DMSP-F17	2005	expected ≥ 2009	833 km	05.30	Close to launch	SSMIS
DMSP-F18	2006	expected ≥ 2010	833 km	08.00	Being built	SSMIS
DMSP-F19	2008	expected ≥ 2012	833 km	05.30	Planned	SSMIS
DMSP-F20	2010	expected ≥ 2014	833 km	05.30	Planned	SSMIS

NOAA acquires and distribute (on request) data from the following instruments:

- **SSM/I (Special Sensor Microwave / Imager)**, for precipitation rate, sea-surface wind speed and sea ice; 4-frequency / 7-channel radiometer (double polarisation for three frequencies); conical scanning with resolution between 13 km at 85 GHz and 55 km at 19 GHz; useful swath 1400 km. See instrument sheet in Annex A3.1.
- **SSM/T (Special Sensor Microwave / Temperature)**, for nearly-all-weather temperature sounding; 7-channel radiometer operating in the 54 GHz band, resolution 200 km, cross-track scanning, 1500 km swath. See instrument sheet in Annex A3.1.
- **SSM/T-2 (Special Sensor Microwave / Humidity)**, for nearly-all-weather humidity sounding; 5-channel radiometer operating in the 183 GHz band, resolution 48 km, cross-track scanning, 1500 km swath. See instrument sheet in Annex A3.1.

Starting with DMSP-F16, SSM/I, SSM/T and SSM/T-2 are progressively being replaced by:

- **SSMIS (Special Sensor Microwave / Imager/Sounder)**, a 21-frequency / 24 channel radiometer (double polarisation for three frequencies); conical scanning with resolution between 13 km in the range 50-190 GHz and 55 km at 19 GHz; nominal swath 1700 km, useful 1400 km. See instrument sheet in Annex A3.1.

3.4 The NPOESS programme

As shown in Tables 3.2.1 and 3.3.1, the NOAA programme foresees the last launch in 2008 and DMSP in 2010. This is because the civilian NOAA and the military DMSP are due to merge into **NPOESS (National Polar-orbiting Operational Environmental Satellite System)**. NPOESS (*Fig. 3.4.1*) is based on three satellites with LST 5.30, 9.30 and 13.30 respectively. The 9.30 satellite will carry a limited number of instruments, since it is coordinated, on the same orbit, with the European Metop (see next). To reduce the risks associated to newly-developed instruments, an **NPP (NPOESS Preparatory Project)** will precede the series. *Table 3.4.1* records the currently envisaged chronology of NPOESS, also showing that satellites in different orbits may carry different instruments.

Table 3.4.1 – Chronology of the NPOESS program (instrument distribution not consolidated)

Satellite	Launch	End of service	Height	LST	Status (Sept 2005)	Instruments
NPP	Oct 2006	expected \geq 2011	824 km	10.30	Being built	VIIRS, CrIS, ATMS, OMPS
NPOESS-1	Nov 2009	expected \geq 2016	833 km	9.30	Planned	VIIRS, CMIS, APS, SARSAT
NPOESS-2	Jun 2011	expected \geq 2018	833 km	13.30	Planned	VIIRS, CrIS, ATMS, CMIS, OMPS, GPSOS, SESS, ERBS, A-DCS, SARSAT
NPOESS-3	Jun 2013	expected \geq 2020	833 km	5.30	Planned	VIIRS, CrIS, ATMS, CMIS, TSIS, ALT, A-DCS, SARSAT
NPOESS-4	Nov 2015	expected \geq 2022	833 km	9.30	Planned	VIIRS, CMIS, APS, SARSAT
NPOESS-5	Jan 2018	expected \geq 2025	833 km	13.30	Planned	VIIRS, CrIS, ATMS, CMIS, OMPS, GPSOS, SESS, ERBS, A-DCS, SARSAT
NPOESS-6	2019	expected \geq 2026	833 km	5.30	Planned	VIIRS, CrIS, ATMS, CMIS, TSIS, ALT, A-DCS, SARSAT



Fig. 3.4.1 – View of NPOESS.

Main payload of NPOESS

Not all instruments of NPOESS have been fully consolidated. The following is known as of end-2003. No new information has been available since.

- ***VIIRS (Visible/Infrared Imager Radiometer Suite)***, the successor of AVHRR: 22-channel VIS/IR radiometer for multipurpose imagery; resolution 400 m for four AVHRR-like channels and one day-night VIS channel, and 800 m for the remaining 17 channels; swath 3000 km. See instrument sheet in Annex A3.1.
- ***CrIS (Cross-track Infrared Sounder)***, the successor of HIRS/4, actually a totally different instrument based on an IR interferometer to provide high-vertical-resolution temperature/humidity sounding; 1302 channels with spectral resolution 0.625 to 2.5 cm⁻¹, resolution 14 km, swath 2200 km. See instrument sheet in Annex A3.1.
- ***ATMS (Advanced Technology Microwave Sounder)***, the successor of AMSU-A and AMSU-B for nearly-all-weather temperature and humidity sounding; 22-channel MW radiometer with bands at 54 and 183 GHz, resolution 16 km at 183 GHz and 32 km at 54 GHz, swath 2200 km. See instrument sheet in Annex A3.1.
- ***CMIS (Conical-scanning Microwave Imager/Sounder)***, the successor of the DMSP SSMIS for multi-purpose MW imagery and supporting temperature/humidity sounding; 63 frequencies, 77 channels (3 with double polarisation, 2 with four polarisations and 1 with six polarisations); resolution from 3 km at 89 GHz to 40 km at 6.6 GHz, swath 1700 km nominal (conical scanning), 1400 km useful. See instrument sheet in Annex A3.1.
- ***OMPS (Ozone Mapping and Profiler Suite)***, the successor of SBUV/2, that adds to the nadir-view (best for vertical profile of ozone) the cross-track scanning capability (swath 2800 km) for total ozone mapping and limb sounding for high-vertical-resolution in the stratosphere. Tracked species: BrO, HCHO, NO₂, O₃, OClO, SO₂. Resolution 250 km (profiler), 50 km (mapper), 1-km vertical (limb). See instrument sheet in Annex A3.1.
- ***GPSOS (Global Positioning System Occultation Sensor)***, for all-weather very-high-vertical resolution temperature and humidity profile by observing the phase delay of GPS signals received during the occultation phase. 0.5-1 km vertical resolution, ~ 300 km horizontal resolution; 500 measurements/day. See instrument sheet in Annex A3.1.
- ***APS (Aerosol Polarimetry Sensor)***, for tropospheric aerosol observation: 9-channel VIS/NIR/SWIR polarimeter scanning along-track within ± 60° and measuring polarisations at 0, 45, 90 and 135° to get the four Stokes components. Resolution 10 km. See instrument sheet in Annex A3.1.
- ***ERBS (Earth Radiation Budget Sensor)***, successor of ERBE and of CERES (Clouds and the Earth's Radiant Energy System), being flown on TRMM and EOS Terra/Aqua; 3 channels (two broad-band, one narrow), resolution 20 km, swath 3000 km. See instrument sheet in Annex A3.1.
- ***ALT (Radar Altimeter)***, derived from Jason-1, for ocean topography and wave height; two frequencies, resolution 25 km, nadir-viewing. See instrument sheet in Annex A3.1.
- ***SESS (Space Environment Sensor Suite)***, successor of SEM/2 for *in situ* measurements of charged particles of the solar wind.
- ***TSIS (Total Solar Irradiance Sensor)***, for total irradiance and the fraction in the 0.2-2.0 μm range.
- ***A-DCS (ARGOS Data Collection System)***, successor of DCS/2, with the additional capability of sending messages to the Data Collection Platform for the purpose of changing its configuration.
- ***SARSAT (Search and Rescue Satellite Aided Tracking System)***, successor of previous one except that only the 406 MHz will be retained.

Data transmission from NPP and NPOESS

The full information from all instruments is stored on board and transmitted in Ka-band to a number of ground stations, according to the standard:

- ***SMD (Stored Mission Data)***, frequency 25.65 GHz, bandwidth 300 MHz, data rate 150 Mbps.

Direct read-out is provided according to two systems, both digital:

- **HRD (High Rate Data)**, for full information in X-band. Main features:
 - frequencies: 7812 or 7830 MHz; bandwidth: 30.8 MHz; polarisation: right hand circular
 - antenna diameter ~ 2 m, G/T ~ dB/K, data rate 20 Mbps;
- **LRD (Low Rate Data)** for selected information in S-band. Main features:
 - frequency: 1706 MHz; bandwidth: 8 MHz; polarisation: right hand circular-
 - antenna diameter ~ 1 m, G/T ~ dB/K, data rate 3.88 Mbps

NPP will only use the HRD standard. The data rate will be 15 Mbps.

3.5 The EPS/Metop Programme

The European *EPS (EUMETSAT Polar System)* draws its origins from the 1980's, when the USA decided to reduce their involvement in the morning orbit for focusing on the afternoon one. ESA started with studying a very large satellite, called POEM (Polar Orbit Earth-observation Mission), based on the 3-axis stabilised "Polar Platform", another ESA programme. Thereafter (1993) the POEM mission was split in two missions: Envisat, focusing on science and environment, and *Metop*, designed for operational meteorology to implement the EPS programme. The EPS Programme was finally approved by the EUMETSAT Council in 1999. Three Metop flight models (*Fig. 3.5.1*) are being built. *Table 3.5.1* records the chronology of the Metop/EPS programme.

Table 3.5.1 – Chronology of the first three satellites (Metop) of the EPS programme

Satellite	Launch	End of service	Height	LST	Status (Sept 2005)	Instruments
Metop-1	Apr 2006	expected \geq 2010	834 km	09.30	Close to launch	AVHRR/3, HIRS/4, AMSU-A, MHS, IASI, GOME-2, GRAS, ASCAT, SEM/2, A-DCS, SARSAT
Metop-2	Oct 2010	expected \geq 2015	834 km	09.30	Being built	AVHRR/3, HIRS/4, AMSU-A, MHS, IASI, GOME-2, GRAS, ASCAT, SEM/2, A-DCS, SARSAT
Metop-3	Apr 2015	expected \geq 2020	834 km	09.30	Being built	AVHRR/3, AMSU-A, MHS, IASI, GOME-2, GRAS, ASCAT, A-DCS

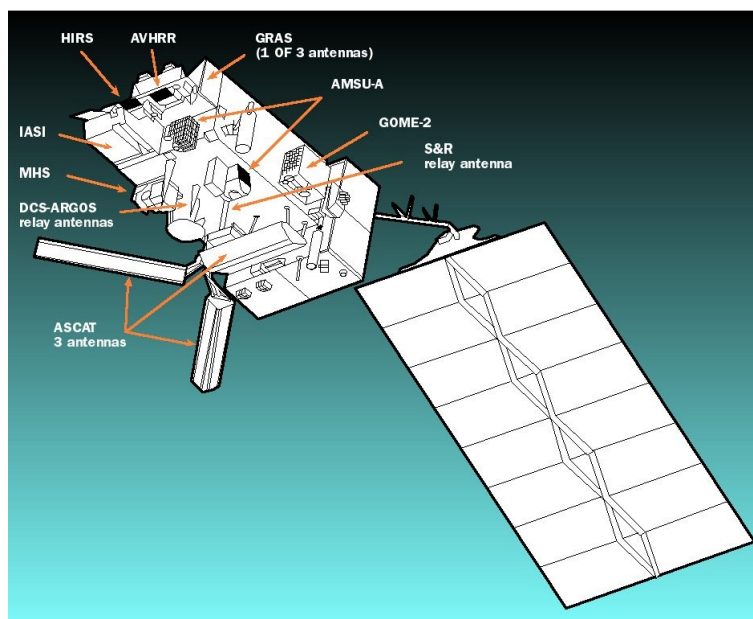

Fig. 3.5.1 – Sketch view of Metop.

Payload of Metop/EPS

- *AVHRR/3 (Advanced Very High Resolution Radiometer)*, provided by NOAA: 6-channel VIS/IR radiometer for multi-purpose imagery with 1.1 km resolution and 2920 km swath. Only 5 channels transmitted (1.6 μ m and 3.7 μ m are alternative, day and night respectively). See instrument sheet in Annex A3.1.
- *HIRS/4 (High-resolution Infrared Radiation Sounder)*, provided by NOAA: 20-channels IR radiometer (including one VIS) for temperature/humidity sounding, resolution 10 km and swath 2080 km. (NB: This instrument will not fly on Metop-3). See instrument sheet in Annex A3.1.

- **AMSU-A (Advanced Microwave Sounding Unit - A)**, provided by NOAA: 15-channel MW radiometer for nearly-all-weather temperature sounding, resolution 48 km, swath 2070 km. See instrument sheet in Annex A3.1.
- **MHS (Microwave Humidity Sounder)**: 5-channel MW radiometer for nearly-all-weather humidity sounding, resolution 16 km, swath 2170 km. See instrument sheet in Annex A3.1.
- **IASI (Infrared Atmospheric Sounding Interferometer)**, cooperation with CNES: IR interferometer to provide high-vertical-resolution temperature/humidity sounding; 8460 channels with spectral resolution 0.25 cm^{-1} , resolution 12 km, swath 2130 km. See instrument sheet in Annex A3.1.
- **GOME-2 (Global Ozone Monitoring Experiment - 2)**, follow-on of the ERS-2 GOME: 4096-channel UV/VIS grating spectrometer (plus 200 polarisation channels) for ozone (total-column and profile) and other trace species (generally total-column). Tracked species: BrO, ClO, H₂O, HCHO, NO, NO₂, NO₃, O₂, O₃, O₄, OClO, SO₂ and aerosol. Resolution 40 km for a 960 km swath or 80 km for a 1920 km swath. See instrument sheet in Annex A3.1.
- **GRAS (GNSS Receiver for Atmospheric Sounding)**, for all-weather high-vertical resolution temperature and humidity profile by observing the phase delay of GPS signals received during the occultation phase. 0.5-1 km vertical resolution, ~ 300 km horizontal resolution; 500 measurements/day. See instrument sheet in Annex A3.1.
- **ASCAT (Advanced SCATterometer)**, follow-on of the ERS 1/2 radar scatterometer for sea-surface wind. Frequency 5.255 GHz, resolution 25 km, two side swaths of 550 km either side of the sub-satellite track. See instrument sheet in Annex A3.1.
- **SEM/2 (Space Environment Monitor)**, provided by NOAA: an instrument suite for *in situ* measurement of the energy of charged particle of the solar wind at orbital height (NB: This instrument will not fly on Metop-3).
- **A-DCS (Advanced Data Collection System)**, provided by NOAA and CNES, also known as *Argos*, to collect data from automatic stations and localise the platform. Platform transmission frequency: 401.65 MHz.
- **SARSAT (Search And Rescue Satellite-Aided Tracking System)**, provided by NOAA: location system for emergency calls from transmitters at 121.5 or 243 or 406 MHz. (NB: This instrument will not fly on Metop-3).

Data transmission from Metop/EPS

The full information from all instruments is stored on board and transmitted in X-band as:

- **GDS (Global Data Stream)**: frequency 7800 MHz, bandwidth 63 MHz, data rate 70 Mbps.

Direct read-out is provided according to two systems, both digital:

- **AHRPT (Advanced High Resolution Picture Transmission)**, for the whole information at full resolution in digital form at S-band frequencies. Main features:
 - frequencies: 1701.3 MHz; bandwidth: 4.5 MHz; polarisation: right-hand circular (backup: 1707 MHz, polarisation right-hand circular);
 - antenna diameter ~ 2 m, G/T ~ 6.0 dB/K, data rate 3.5 Mbps;
- **LRPT (Low Resolution Picture Transmission)**, for selected information (3 AVHRR channel JPEG-compressed and ATOVS data) in digital form at VHF frequencies. Main features:
 - frequency: 137.9 MHz; bandwidth: 150 kHz; polarisation: right-hand circular (backup: 137.1 MHz, polarisation right-hand circular)
 - Yagi antenna, G/T ~ -22.4 dB/K, data rate 72 kbps.

3.6 The Meteor programme

The Russian *Meteor* programme, if considered inclusive of the experiments carried out on the multi-purpose *Cosmos* series, has origins nearly as long-standing as those of the American TIROS-ESSA-ITOS-NOAA-POES. However, the first satellite dedicated to operational meteorology is dated 1969. There have been three series, Meteor-1, Meteor-2 and Meteor-3, in non-sunsynchronous orbits whereas the current one, Meteor-3M, is sunsynchronous. The programme run through the following phases.

- **Meteor-1**, 25 flight models launched, 3-axis stabilised. Instruments:
 - TV camera (0.4-0.8 μm), resolution 1.25-3 km, swath 1000 km
 - IR radiometer (8-12 μm), resolution 15 km, swath 1000 km
 - AC, radiometer for Earth radiation budget (0.3-30 μm), resolution 45 km, swath 2500 km.
- **Meteor-2**, 21 flight models launched, 3-axis stabilised. Instruments:
 - TV camera (0.4-0.8 μm), resolution 1.25-3 km, swath 1000 km
 - IR radiometer (8-12 μm), resolution 15 km, swath 1000 km
 - SM, IR temperature and humidity sounder (see next)
 - RMK-2, *in situ* charged particles counters (see next).
- **Meteor-3**, 7 flight models launched, 3-axis stabilised. Instruments:
 - MR-2000M and MR-900B, two cameras (0.5-0.8 μm), one with resolution 1 km and swath 3100 km, the other with resolution 1.5 km and swath 2600 km;
 - Klimat, an IR radiometer (10.5-12.5 μm) with resolution 3 km and swath 3100 km;
 - SM, a 10-channel IR radiometer in the range 9.65-18.70 μm for temperature and humidity sounding; resolution 42 km, swath 1000 km;
 - RMK-2, a suite of charged particle counters to *in situ* observe solar wind;
 - TOMS (Total Ozone Mapping Spectrometer) (only on Meteor-3-6), a NASA-provided six-band UV spectrometer (0.31-0.38 μm) with resolution 47 km and swath 3100 km;
 - ScaRaB (Scanner for Radiation Budget) (only on Meteor-3-7) a CNES-provided radiometer with two broad-band (0.2-4.0 μm and 0.2-50 μm) and two narrow-band (0.5-0.7 μm and 10.5-12.5 μm) channels; resolution 60 km, swath 3200 km.

The current series, *Meteor-3M*, is based on a 3-axis stabilised platform in a sunsynchronous orbit (see *Fig. 3.6.1*). The first flight model, currently operational, was launched in December 2001. With the second flight model the name has been changed to ~~of the current series Meteor-3M-SC~~ *Meteor-M*. Two flight models of Meteor-M are being developed. *Table 3.6.1* records the chronology of the Meteor programme.

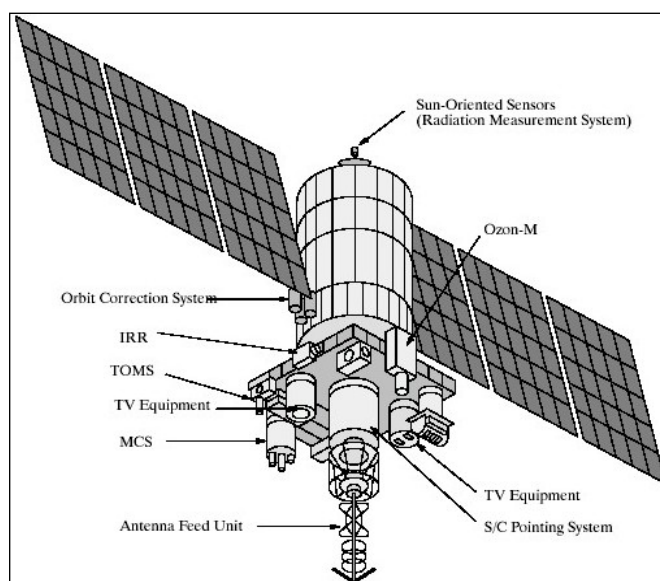

Fig. 3.6.1 – Sketch view of Meteor-3.

Table 3.6.1 – Chronology of the Meteor programme (in bold the satellites active in Sept 2005)

Satellite	Launch	End of service	Height	LST or inclin.	Status (Sept 2005)	Instruments
Meteor-1-1	23 Mar 1969	~ 1970	680 km	81.2°	Inactive	TV, IR, AC
Meteor-1-2	6 Oct 1969	~ 1970	660 km	81.2°	Inactive	TV, IR, AC
Meteor-1-3	17 Mar 1970	~ 1971	650 km	81.2°	Inactive	TV, IR, AC
Meteor-1-4	28 Apr 1970	~ 1971	680 km	81.2°	Inactive	TV, IR, AC
Meteor-1-5	23 Jun 1970	~ 1971	880 km	81.2°	Inactive	TV, IR, AC
Meteor-1-6	15 Oct 1970	~ 1971	650 km	81.2°	Inactive	TV, IR, AC
Meteor-1-7	20 Jan 1971	~ 1972	650 km	81.2°	Inactive	TV, IR, AC
Meteor-1-8	17 Apr 1971	~ 1972	630 km	81.2°	Inactive	TV, IR, AC
Meteor-1-9	6 Jul 1971	~ 1972	630 km	81.2°	Inactive	TV, IR, AC
Meteor-1-10	29 Dec 1971	~ 1972	890 km	81.2°	Inactive	TV, IR, AC
Meteor-1-11	30 Mar 1972	~ 1973	890 km	81.2°	Inactive	TV, IR, AC
Meteor-1-12	30 Jun 1972	~ 1973	910 km	81.2°	Inactive	TV, IR, AC
Meteor-1-13	27 Oct 1972	~ 1973	900 km	81.2°	Inactive	TV, IR, AC
Meteor-1-14	20 Mar 1973	~ 1974	890 km	81.2°	Inactive	TV, IR, AC
Meteor-1-15	29 May 1973	~ 1974	890 km	81.2°	Inactive	TV, IR, AC
Meteor-1-16	5 Mar 1974	~ 1975	880 km	81.2°	Inactive	TV, IR, AC
Meteor-1-17	24 Apr 1974	~ 1975	890 km	81.2°	Inactive	TV, IR, AC
Meteor-1-19	28 Oct 1974	~ 1975	890 km	81.2°	Inactive	TV, IR, AC
Meteor-1-20	17 Dec 1974	~ 1975	890 km	81.2°	Inactive	TV, IR, AC
Meteor-1-21	1 Apr 1975	~ 1976	890 km	81.2°	Inactive	TV, IR, AC
Meteor-2-1	11 Jul 1975	~ 1976	890 km	81.3°	Inactive	TV, IR, SM, RMK-2
Meteor-1-22	18 Sep 1975	~ 1976	890 km	81.2°	Inactive	TV, IR, AC
Meteor-1-23	25 Dec 1975	~ 1976	880 km	81.2°	Inactive	TV, IR, AC
Meteor-1-24	7 Apr 1976	~ 1977	880 km	81.2°	Inactive	TV, IR, AC
Meteor-1-26	5 Oct 1976	~ 1977	890 km	81.2°	Inactive	TV, IR, AC
Meteor-2-2	6 Jan 1977	~ 1978	910 km	81.3°	Inactive	TV, IR, SM, RMK-2
Meteor-1-28	5 Apr 1977	~ 1978	890 km	81.2°	Inactive	TV, IR, AC
Meteor-2-3	14 Dec 1977	~ 1979	890 km	81.2°	Inactive	TV, IR, SM, RMK-2
Meteor-2-4	1 Mar 1979	~ 1980	880 km	81.2°	Inactive	TV, IR, SM, RMK-2
Meteor-2-5	31 Oct 1979	~ 1980	890 km	81.2°	Inactive	TV, IR, SM, RMK-2
Meteor-2-6	9 Sep 1980	~ 1981	890 km	81.2°	Inactive	TV, IR, SM, RMK-2
Meteor-2-7	15 May 1981	~ 1982	890 km	81.3°	Inactive	TV, IR, SM, RMK-2
Meteor-2-8	25 Mar 1982	~ 1983	960 km	82.5°	Inactive	TV, IR, SM, RMK-2
Meteor-2-9	15 Dec 1982	~ 1984	870 km	81.3°	Inactive	TV, IR, SM, RMK-2
Meteor-2-10	28 Oct 1983	~ 1985	840 km	81.2°	Inactive	TV, IR, SM, RMK-2
Meteor-2-11	5 Jul 1984	~ 1985	960 km	82.5°	Inactive	TV, IR, SM, RMK-2
Meteor-2-12	7 Feb 1985	~ 1986	960 km	82.5°	Inactive	TV, IR, SM, RMK-2

Meteor-3-1	24 Oct 1985	~ 1987	1250 km	82.5°	Inactive	MR-2000M, MR-900B, Klimat, SM,RMK-2
Meteor-2-13	6 Dec 1985	~ 1987	960 km	82.5°	Inactive	TV, IR, SM, RMK-2
Meteor-2-14	27 May 1986	~ 1987	960 km	82.5°	Inactive	TV, IR, SM, RMK-2
Meteor-2-15	5 Jan 1987	~ 1988	960 km	82.5°	Inactive	TV, IR, SM, RMK-2
Meteor-2-16	18 Aug 1987	~ 1988	960 km	82.5°	Inactive	TV, IR, SM, RMK-2
Meteor-2-17	30 Dec 1987	~ 1989	960 km	82.5°	Inactive	TV, IR, SM, RMK-2
Meteor-2-18	30 Jan 1988	~ 1989	960 km	82.5°	Inactive	TV, IR, SM, RMK-2
Meteor-3-3	26 Jul 1988	~ 1990	1210 km	82.5°	Inactive	MR-2000M, MR-900B, Klimat, SM,RMK-2
Meteor-2-19	28 Feb 1989	~ 1990	960 km	82.5°	Inactive	TV, IR, SM, RMK-2
Meteor-3-4	25 Oct 1989	~ 1992	1210 km	82.5°	Inactive	MR-2000M, MR-900B, Klimat, SM,RMK-2
Meteor-2-20	28 Jun 1990	~ 1992	960 km	82.5°	Inactive	TV, IR, SM, RMK-2
Meteor-2-21	28 Sep 1990	~ 2001	960 km	82.5°	Inactive	TV, IR, SM, RMK-2
Meteor-3-5	24 Apr 1991	2003	1210 km	82.5°	Inactive	MR-2000M, MR-900B, Klimat, SM,RMK-2
Meteor-3-6	15 Aug 1991	~ 1993	1210 km	82.5°	Inactive	MR-2000M, MR-900B, Klimat, SM,RMK-2, TOMS
Meteor-2-22	31 Aug 1993	1994	960 km	82.5°	Inactive	TV, IR, SM, RMK-2
Meteor-3-7	25 Jan 1994	1995	1200 km	82.5°	Inactive	MR-2000M, MR-900B, Klimat, SM, ScaRaB
Meteor-3M	10 Dec 2001	expected ≥ 2005	830 km	9.15	Operational	MR-2000M1, Klimat, MIVZA, MTVZA, MSU-E, SAGE-III, SFM-2, KGI-4C, MSGI-5EI
Meteor-M-1	2006	expected ≥ 2009	830 km	9.15	Being built	MSU-MR, MTVZA, KMSS, Severjanin, GGAK-M
Meteor-M-2	2008	expected ≥ 2012	830 km	9.15	Planned	MSU-MR, IRFS-2, MTVZA, KMSS, Radiomet, Severjanin, GGAK-M, DCS

Payload of the current satellite, Meteor-3M

- **MR-2000M1**, TV camera (0.5-0.8 μm), resolution 1 km, swath 3100 km. See instrument sheet in Annex A3.1.
- **Klimat**, IR radiometer (10.5-12.5 μm), resolution 3.0 km, swath 3100 km. See instrument sheet in Annex A3.1.
- **MIVZA**, 3-frequencies / 5 channels (double polarisation at two frequencies) MW conical-scanning radiometer, resolution ~~.....~~25 km at 94 GHz, ~~.....~~100 km at 20 GHz, swath 1500 km. There is no evidence that the instrument has been actually flown.
- **MTVZA**, a 20-frequency / 26-channel radiometer (double polarisation for six frequencies), for multi-purpose MW imagery and nearly-all-weather temperature/humidity sounding; conical scanning with resolution between 14 km at 183.31 GHz and 90 km at 18.7 GHz, swath 1500 km. See instrument sheet in Annex A3.1.
- **MSU-E**, 3-channels VIS/NIR radiometer (0.5-0.6, 0.6-0.7, 0.8-0.9 μm) for high-resolution (38 m) limited swath imagery (46 km with possible pointing within 430 km). See instrument sheet in Annex A3.1.
- **SAGE-III (Stratospheric Aerosol and Gas Experiment - III)**, a NASA-provided grating spectrometer in 9 bands of the 290-1550 nm range in solar or lunar occultation. Species: H₂O, NO₂, NO₃, O₃, OClO and aerosol. Resolution ~ 300 km (horizontal), 1-2 km (vertical) in the range 10-85 km. See instrument sheet in Annex A3.1.
- **SFM-2**, a UV spectrometer for ozone during solar occultation. Spectral range ~~.....~~0.2-0.51 nm, resolution ~ 300 km (horizontal), 1-2 km (vertical) in the range 10-60 km. There is no evidence that the instrument has been actually flown.
- **KGI-4C** and **MSGI-5EI**, suite of charged particles counters for *in situ* observation of solar wind.

Because of technical problems, only MSU-E and SAGE-III data are transmitted to user stations.

Payload of Meteor-M

- **MSU-MR**, replacing MR-2000M1 + Klimat for multi-purpose imagery: 6-channel VIS/IR radiometer, resolution 1.0 km, swath 2800 km. See instrument sheet in Annex A3.1.
- **MTVZA**, a 21-frequency / 29-channel radiometer (double polarisation for eight frequencies), with 3 more channels than on Meteor-3M, for multi-purpose MW imagery and nearly-all-weather temperature/humidity sounding; conical scanning with resolution between 14 km at 183.31 GHz and 130 km at 10.6 GHz, swath 1500 km. See instrument sheet in Annex A3.1.
- **IRFS-2**, IR interferometer for high-vertical-resolution temperature/humidity sounding, about 4000 channels with spectral resolution 0.5 cm^{-1} , resolution 35 km, swath 1000 km to 2500 km. IRFS-2 is planned for Meteor-M-2. See instrument sheet in Annex A3.1.
- **KMSS**, replacing MSU-E for multi-purpose imagery: 6-channel imaging system, resolution 50 or 100 m, swath 400 or 900 km. See instrument sheet in Annex A3.1.
- ~~by adding one channel (μm) and degrading the resolution to 100 m in favour of larger swath.~~
- **Radiomet**, for all-weather very-high-vertical resolution temperature and humidity profile by observing the phase delay of GPS signals received during the occultation phase. 0.5-1 km vertical resolution, ~ 300 km horizontal resolution; 500 measurements/day. Radiomet is planned for Meteor-M-2. See instrument sheet in Annex A3.1.
- **Severjanin**, a Synthetic Aperture Radar (SAR): X-band (9.623,275-GHz), resolution either 400 or 1000 m, swath up to 600 km. See instrument sheet in Annex A3.1.
- **GGAK-M**, replacing KGI-4C + MSGI-5EI for *in situ* observation of charged particles in solar wind.
- **DCS (Data Collection System)**, to collect and relay data from automatic stations (on Meteor-M-2); uplink: frequency 402.1-402.5 MHz, data rate 400 or 1200 bps.

Data transmission from Meteor-M

Global data are stored on board and transmitted in X-band to:

- **Data Acquisition station (DA):** ~~2 frequencyfrequencies:~~ 8128 ~~;-or_~~8320 MHz, bandwidth 32-~~250~~ MHz, data rate: 15.36, 30.72, 61.44 or 122.88 Mbps.

~~As for direct read-out, Meteor-M has lost the APT transmission capability and can provide a HRPT-like transmission at 1700 GHz, by with data in non-HRPT-compatible format.~~ Meteor-M direct-read-out will comply with standards similar to NOAA:

- **HRPT (Advanced High Resolution Picture Transmission)**, for the whole information at full resolution in digital form at S-band frequencies. Main features-
 - ~~frequencyfrequency:~~ 1700 MHz; bandwidth: 2.0 MHz; polarisation: right-hand circular
 - ~~antenna diameter ~ 2 m, G/T ~ 6.0 dB/K, data rate 665 kbps.~~
- **LRPT (Low Resolution Picture Transmission)**, for selected information. Main features:
 - ~~frequencyfrequencies:~~ 137.89 or 137.1 MHz; bandwidth: 150 kHz; polarisation: right-hand circular
 - ~~Yagi antenna, G/T ~ -22.4 dB/K, data rate 72 kbps.~~

In addition, Meteor-M-2 will provide relay of data from DCP's and other sources through:

- **Onboard radio-complex** in the frequency band 1690-1710 MHz, bandwidth 2 MHz, polarisation right-hand circular, data rate 400 or 1200 bps.

3.7 The FY-1 and FY-3 programmes

The Chinese *FY-1* and *FY-3* series⁴ started in 1988. The first two satellites (FY-1A and FY-1/B) were using the ITOS platform (see section 3.2 and Fig. 3.2.3), the next two (FY-1C and FY-1D) a new platform (*Fig. 3.7.1*). The FY-3 series is being developed and include 7 flight models. All satellites are 3-axis stabilised, in sunsynchronous orbit. *Table 3.7.1* records the chronology of the FY-1 / FY-3 programme.

Table 3.7.1 – Chronology of the FY-1/FY-3 programme (in bold the satellites active in Sept 2005)

Satellite	Launch	End of service	Height	LST	Status (Sept 2005)	Instruments
FY-1A	7 Sep 1988	16 Oct 1988	900 km	11.30	Inactive	MVISR, SEM
FY-1B	3 Sep 1990	5 Aug 1991	900 km	16.00	Inactive	MVISR, SEM
FY-1C	10 May 1999	?????	862 km	6.45	Inactive	MVISR, SEM
FY-1D	15 May 2002	expected ≥ 2006	866 km	8.20	Operational	MVISR, SEM
FY-3A	2007	expected ≥ 2010	836 km	10.00	Being built	VIRR, MERSI, MWRI, IRAS, MWTS, MWHS, TOU/SBUS, SEM
FY-3B	2010	expected ≥ 2013	836 km	10.00	Planned	VIRR, MERSI, MWRI, IRAS, MWTS, MWHS, TOU/SBUS, SEM
FY-3C	2012	expected ≥ 2015	836 km	10.00	Planned	VIRR, MERSI, MWRI, IRAS, MWTS, MWHS, TOU/SBUS, SEM
FY-3D	2014	expected ≥ 2017	836 km	10.00	Planned	VIRR, MERSI, MWRI, IRAS, MWTS, MWHS, TOU/SBUS, SEM
FY-3E	2016	expected ≥ 2019	836 km	10.00	Planned	VIRR, MERSI, MWRI, IRAS, MWTS, MWHS, TOU/SBUS, SEM
FY-3F	2018	expected ≥ 2021	836 km	10.00	Planned	VIRR, MERSI, MWRI, IRAS, MWTS, MWHS, TOU/SBUS, SEM
FY-3G	2020	expected ≥ 2023	836 km	10.00	Planned	VIRR, MERSI, MWRI, IRAS, MWTS, MWHS, TOU/SBUS, SEM

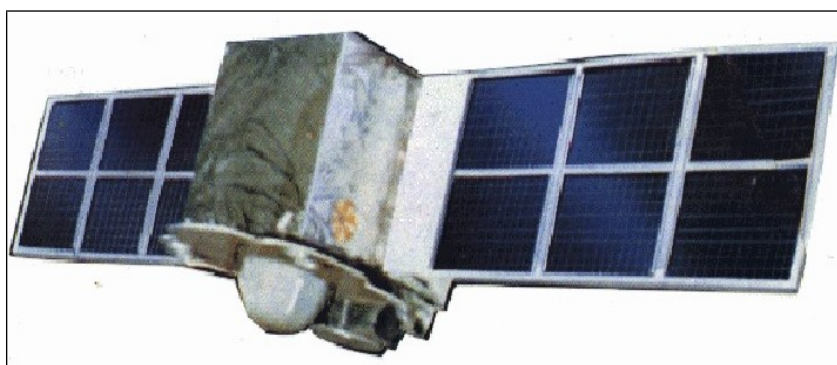

Fig. 3.7.1 – View of FY-1.

Payload of FY-1

At end 2005, the operational satellite is *FY-1D*, launched in 2002. It embarks a the following instruments:

- *MVISR (Multichannel Visible and Infrared Scanning Radiometer)*, VIS/IR radiometer for multi-purpose imagery, resolution 1.1 km, swath 2800 km. On FY-1A and FY-1B MVISR had 5 channels

⁴ FY = *Feng-Yun*, “Wind and Cloud”.

(0.48-0.53, 0.53-0.58, 0.58-0.68, 0.725-1.10 e 10.5-12.5 μm). On FY-1C and FY-1D there are 10 channels. See instrument sheet in Annex A3.1.

- **SEM (Space Environment Monitoring)** for *in situ* observation of charged particles in solar wind.

Data transmission from FY-1

Global data are stored on board and transmitted in S-band as:

- **China Delayed Picture Transmission (CDPT)**: MVISR imagery with resolution reduced to 4 km; frequency 1708.5 MHz (backup 1695.5 MHz, bandwidth 5.6 MHz, data rate 1.33 Mbps).

As for direct read-out, there is:

- **CHRPT (China High Resolution Picture Transmission)**, for the whole information at full resolution in digital form at S-band frequencies. Main features:
 - frequencies: 1700.5 MHz (backup 1704.5 GHz); bandwidth: 5.6 MHz; polarisation: right-hand circular
 - antenna diameter ~ 2 m, G/T ~ 6.0 dB/K, data rate 1.33 kbps.

Payload of FY-3

- **VIRR (Visible and Infra Red Radiometer)**, close to MVISR except that the water vapour channel at 932 nm is replaced by 1360 nm; 10-channel VIS/IR radiometer for multi-purpose imagery, resolution 1.1 km, swath 2800 km. See instrument sheet in Annex A3.1.
- **MERSI (Medium Resolution Spectral Imager)**, 20-channel radiometer (19 in VIS/NIR/SWIR + one TIR at 10.0-12.5 μm) for ocean colour and vegetation indexes; resolution 250 m for 4 VIS/NIR and the TIR channel, 1 km for all other channels; swath 2800 km. See instrument sheet in Annex A3.1.
- **MWRI (Micro-Wave Radiation Imager)**, 6-frequencies / 12 channels (all frequencies in double polarisation) for multi-purpose MW imagery. Conical-scanning radiometer, resolution 9.5 x 15 km at 90 GHz, 30 x 50 km at 19 GHz, swath 1400 km. See instrument sheet in Annex A3.1.
- **IRAS (Infra Red Atmospheric Sounder)**, 26-channel IR radiometer (including one VIS) for temperature/humidity sounding, resolution 17 km, swath 2250 km. See instrument sheet in Annex A3.1.
- **MWTS (Micro-Wave Temperature Sounder)**, 4-channel MW radiometer for nearly-all-weather temperature sounding, 54 GHz band, resolution 70 km, cross-track scanning, swath 2200 km. See instrument sheet in Annex A3.1.
- **MWHS (Micro-Wave Humidity Sounder)**, 4-frequency / 5-channel (one frequency in double polarisation) MW radiometer for nearly-all-weather humidity sounding, 118 GHz band, resolution 15 km, cross-track scanning, swath 2700 km. See instrument sheet in Annex A3.1.
- **TOU/SBUS (Total Ozone Unit and Solar Backscatter Ultraviolet Sounder)**, a suite of two UV spectro-radiometers, one (TOU) with 6 channels in the 308-360 nm range, resolution 50 km, swath 3000 km, for total ozone; the other one (SBUS) with 12 channels in the range 252-380 nm, resolution 200 km, nadir viewing, for ozone profile. See instrument sheet in Annex A3.1.
- **SEM (Space Environment Monitoring)** for *in situ* observation of charged particles in solar wind.

Data transmission from FY-3

The data rate of the MERSI instrument requires moving to X-band, both for global data recovery and for full information real-time transmission. Global data stored on board are transmitted as:

- **Delayed Picture Transmission (DPT)**: frequency 8146 MHz, bandwidth 128 MHz, data rate 93 Mbps.

Direct read-out is provided according to two systems:

- **MPT (Medium-resolution Picture Transmission)**, for full information in X-band. Main features:
 - frequency: 7775 MHz; bandwidth: 37.4 MHz; polarisation: right hand circular
 - antenna diameter ~ 3 m, G/T ~ 21.4 dB/K, data rate 18.7 Mbps;
- **AHRPT (Advanced High Resolution Picture Transmission)** for selected information in S-band. Main features:
 - frequency: in the range 1704.5 MHz; bandwidth: 5.6 MHz; polarisation: right hand circular
 - antenna diameter ~ 3 m, G/T ~ 6.8 dB/K, data rate 4.2 Mbps.

3.8 Coverage provided by sunsynchronous satellites in 2005 and 2007

In this Section the compliance of the constellation of sunsynchronous meteorological satellites with WMO requirements is evaluated. Since the requirement calls for four satellites at optimally-spaced LST, *Table 3.9.1* identifies eight time sectors each wide 3 hours. In addition, since four major satellites are expected to be launched in 2006 and 2007 (Metop-1, Meteor-M-1, FY-3A and NPP), the perspective situation in year 2007 is shown in *Table 3.9.2*.

Table 3.9.1 - Coverage from sunsynchronous satellites as of Sept 2005 (CGMS XXXIII)

Time	Satellite	LST	Instruments
00-03	NOAA-18	01.54 d	AVHRR/3, HIRS/3, AMSU-A, M, SBUV/2, SEM/2, Argos, SARSAT
	NOAA-16	02.54 d	AVHRR/3, HIRS/3, AMSU-A, AMSU-B, SBUV/2, SEM/2, Argos, SARSAT
03-06	NOAA-15	06.00 d	AVHRR/3, HIRS/3, AMSU-A, AMSU-B, SEM/2, Argos, SARSAT
06-09	DMSP F13	06.25 d	SSM/I, SSM/T + others not available
	DMSP F16	08.00 d	SSMIS
	FY-1D	08.20 a	MVISR, SEM
09-12	Meteor-3M	09.15 d	MR-2000M1, Klimat, MIVZA, MTVZA, MSU-E, SAGE-III, SFM-2, KGI-4C, MSGI-5E1
	DMSP F15	09.15 d	SSM/I, SSM/T, SSM/T-2 + others not available
	NOAA-17	10.24 d	AVHRR/3, HIRS/3, AMSU-A, AMSU-B, SBUV/2, SEM/2, Argos, SARSAT
12-15	NOAA-18	13.54 a	AVHRR/3, HIRS/3, AMSU-A, MHS, SBUV/2, SEM/2, Argos, SARSAT
	NOAA-16	14.54 a	AVHRR/3, HIRS/3, AMSU-A, AMSU-B, SBUV/2, SEM/2, Argos, SARSAT
15-18	NOAA-15	18.00 a	AVHRR/3, HIRS/3, AMSU-A, AMSU-B, SEM/2, Argos, SARSAT
18-21	DMSP F13	18.25 a	SSM/I, SSM/T + others not available
	DMSP F16	20.00 d	SSMIS
	FY-1D	20.20 a	MVISR, SEM
21-24	Meteor-3M	21.15 a	MR-2000M1, Klimat, MIVZA, MTVZA, MSU-E, SAGE-III, SFM-2, KGI-4C, MSGI-5E1
	DMSP F15	21.15 a	SSM/I, SSM/T, SSM/T-2 + others not available
	NOAA-17	22.24 a	AVHRR/3, HIRS/3, AMSU-A, AMSU-B, SBUV/2, SEM/2, Argos, SARSAT

Table 3.8.2 - Coverage from sunsynchronous satellites as expected in 2007

Time	Satellite	LST	Instruments
00-03	NOAA-18	02.00 d	AVHRR/3, HIRS/3, AMSU-A, MHS, SBUV/2, SEM/2, Argos, SARSAT
03-06	DMSP F17	05.30 d	SSMIS
06-09	DMSP F16	08.00 d	SSMIS
	FY-1D	08.20 d	MVISR, SEM
09-12	Meteor-M-1	09.15 d	MSU-MR, MTVZA, KMSS, Severjanin, GGAK-M
	Metop-1	09.30 d	AVHRR/3, HIRS/4, AMSU-A, MHS, IASI, GOME-2, GRAS, ASCAT, SEM/2, Argos, SARSAT
	FY-3A	10.00 d	VIRR, MERSI, MWRI, IRAS, MWTS, MWHS, TOU/SBUS, SEM
	NOAA-17	10.20 d	AVHRR/3, HIRS/3, AMSU-A, AMSU-B, SBUV/2, SEM/2, Argos, SARSAT
	NPP	10.30 d	VIIRS, CrIS, ATMS, OMPS
12-15	NOAA-18	14.00 a	AVHRR/3, HIRS/3, AMSU-A, MHS, SBUV/2, SEM/2, Argos, SARSAT
15-18	DMSP F17	17.30 a	SSMIS
18-21	DMSP F16	20.00 a	SSMIS

	FY-1D	20.20 a	MVISR, SEM
21-24	Meteor-M-1	21.15 d	MSU-MR, MTVZA, KMSS, Severjanin, GGAK-M
	Metop-1	21.30 a	AVHRR/3, HIRS/4, AMSU-A, MHS, IASI, GOME-2, GRAS, ASCAT, SEM/2, Argos, SARSAT
	FY-3A	22.00 a	VIRR, MERSI, MWRI, IRAS, MWTS, MWHS, TOU/SBUS, SEM
	NOAA-17	22.20 a	AVHRR/3, HIRS/3, AMSU-A, AMSU-B, SBUV/2, SEM/2, Argos, SARSAT
	NPP	22.30 a	VIIRS, CrIS, ATMS, OMPS

Fig. 3.8.1, Fig. 3.8.2 and Fig. 3.8.3 show the 3-hourly coverage as current (September 2005) and expected (in 2007) for the VIS/IR imagery mission, the IR/MW sounding mission and MW conical scanners respectively. These figures should be compared to Fig. 1.2 showing the WMO requirement.

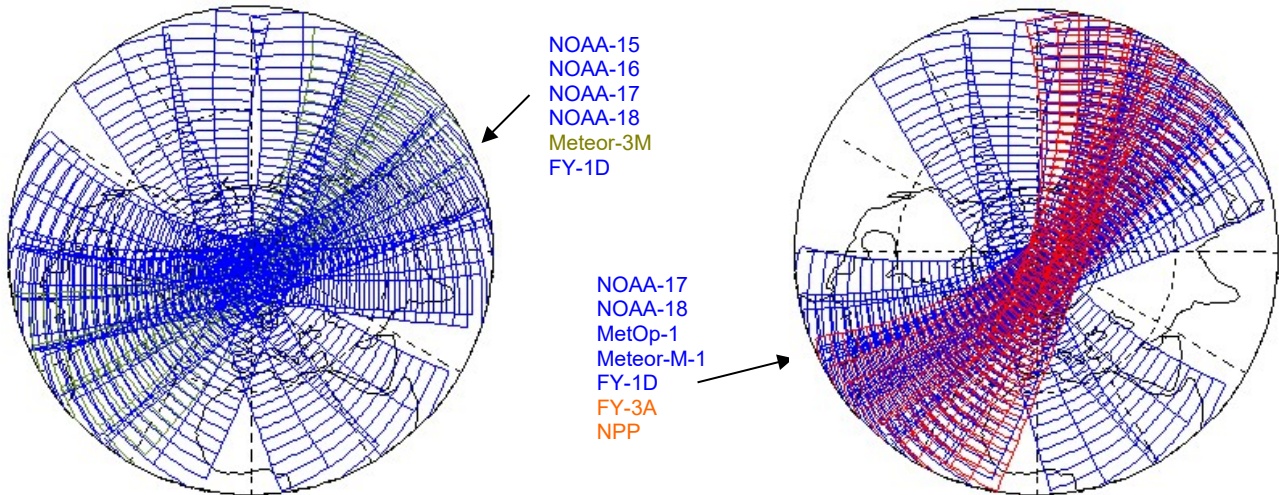

Fig. 3.8.1 – 3-hourly coverage for the VIS/IR imagery mission. Left: Sept 2005. Right: 2007.
 Green: MSP 2000M1 + Klimat Blue: AVHRR, MIVIS, MSU MB Red: MERSI+VIRB

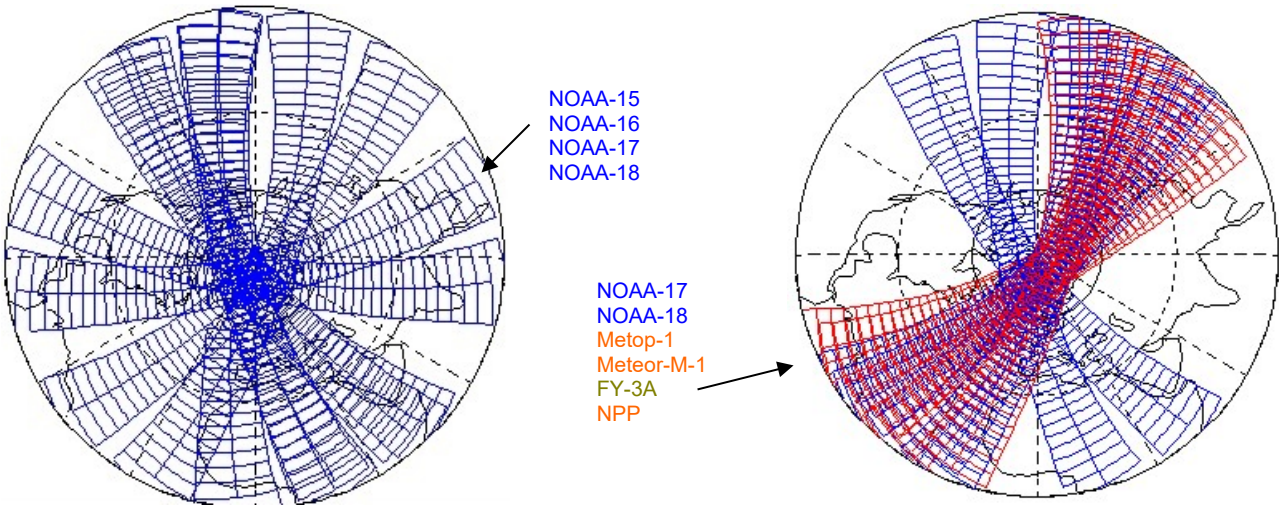

Fig. 3.8.2 – 3-hourly coverage for the IR/MW sounding mission. Left: Sept 2005. Right: 2007.
 Green: IPAS+MWTS+MWHS Blue: ATOVS Red: ATOVS+IASI IPES 2+MTVZA

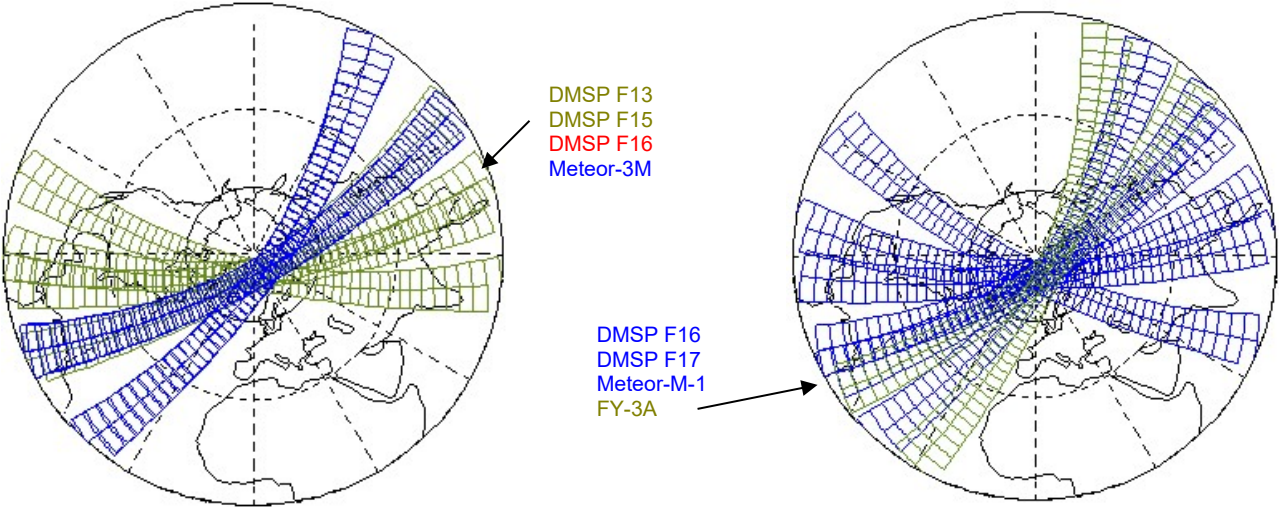

Fig. 3.8.3 – 3-hourly coverage for MW conical scanners. Left: Sept 2005. Right: 2007.
 Green: SSM/I, MWRI. Blue: imaging-sounders: SSMIS, MTVZA. Red: reserved for CMIS (2000)

Table 3.8.3, **Table 3.8.4** and **Table 3.8.5** highlight the situation of orbital parameters in respect of the VIS/IR imagery mission, the IR/MW sounding mission and for MW conical scanners, respectively. The role of these Tables is to identify the time of the day when gaps occur because of the orbital configuration of the constellation. The *gaps*, instead, arise from the combined effect of the orbital configuration and the instrument swaths (limited to ~ 2200 km for sounders and ~ 1400 km for MW conical scanners), and can be appreciated from Fig. 3.8.1, Fig. 3.8.2 and Fig. 3.8.3.

Table 3.8.3 – Coverage of the VIS/IR imagery mission (cells with $\Delta LST > 3$ h are highlighted)

2005	NOAA-18	NOAA-16	NOAA-15	FY-1D	Meteor-3M	NOAA-17	NOAA-18	NOAA-16	NOAA-15	FY-1D	Meteor-3M	NOAA-17	NOAA-18
LST	01.54	02.54	06.00	08.20	09.15	10.24	13.54	14.54	18.00	20.20	21.15	22.24	01.54
ΔLST	1 h 00'	3 h 06'	2 h 20'	0 h 55'	1 h 09'	3 h 30'	1 h 00'	3 h 05'	2 h 20'	0 h 55'	1 h 09'	3 h 30'	

2007	NOA A-18	FY-1D	Meteo r-M-1	Metop -1	FY-3A	NOA A-17	NPP	NOA A-18	FY-1D	Meteo r-M-1	Metop -1	FY-3A	NOA A-17	NPP	NOAA-18
LST	02.00	08.20	09.15	09.30	10.00	10.20	10.30	14.00	20.20	21.15	21.30	22.00	22.20	22.30	02.00
ΔLST	6 h 20'	0 h 55'	0 h 15'	0 h 30'	0 h 20'	0 h 10'	3 h 30'	6 h 20'	0 h 55'	0 h 15'	0 h 30'	0 h 20'	0 h 10'	3 h 30'	

Analysis of Table 3.8.3

- **2005** – close to optimal; only in four cases the gaps exceeds 3 hours, marginally in two cases (LST around 04.30 and 16.30 actual, by half-an-hours around noon and midnight);
- **2007** – severe lack of satellite availability (actual $\Delta LST \sim 6$ h 20') in early morning (~ 05.00) and late-afternoon (~ 17.00); minor gaps ($\Delta LST \sim 3$ h 30') around noon and midnight.

Table 3.8.4 – Coverage of the IR/MW sounding mission (cells with $\Delta LST > 3$ h are highlighted)

2005	NOAA-18	NOAA-16	NOAA-15	NOAA-17	NOAA-18	NOAA-16	NOAA-15	NOAA-17	NOAA-18
LST	01.54	02.54	06.00	10.24	13.54	14.54	18.00	22.24	01.54
ΔLST	1 h 00'	3 h 06'	4 h 24'	3 h 30'	1 h 00'	3 h 06'	4 h 24'	3 h 30'	

2007	NOAA-18	Meteo r-N-1	Metop -1	FY-3A	NOAA-17	NPP	NOAA-18	Meteo r-M-2	Metop -1	FY-3A	NOAA-17	NPP	NOAA-18
LST	02.00	09.15	09.30	10.00	10.20	10.30	14.00	21.15	21.30	22.00	22.20	22.30	02.00
ΔLST	7 h 15'	0 h 15'	0 h 30'	0 h 20'	0 h 10'	3 h 30'	7 h 15'	0 h 15'	0 h 30'	0 h 20'	0 h 10'	3 h 30'	

Analysis of Table 3.8.4

- **2005** – the 3-hourly requirement is slightly missed around 02.30 and 14.30, missed by half-an-hour around 04.30 and 16.30, and substantially missed (nearly 4 h 30') around 08.15 and 20.15;
- **2007** – severe lack of satellite availability (actual $\Delta LST \sim 7$ h 15') in early morning (~ 05.30) and late-afternoon (~ 17.30); minor gaps ($\Delta LST \sim 3$ h 30') around noon and midnight.

Table 3.8.5 – Coverage of MW conical scanners (cells with $\Delta LST > 3$ h are highlighted)

2005	DMSP F13	DMSP F16	Meteor-3M	DMSP F15	DMSP F13	DMSP F16	Meteor-3M	DMSP F15	DMSP F13
LST	06.25	08.00	09.15	09.15	18.25	20.00	21.15	21.15	06.25
ΔLST	1 h 35'	1 h 15'	0 h 00'	9 h 10'	1 h 35'	1 h 15'	0 h 00'	9 h 10'	

2007	DMSP F17	DMSP F16	Meteor-M-1	FY-3A	DMSP F17	DMSP F16	Meteor-M-1	FY-3A	DMSP F17
LST	05.30	08.00	09.15	10.00	17.30	20.00	21.15	22.00	05.30
ΔLST	2 h 30'	1 h 15'	0 h 45'	7 h 30'	2 h 30'	1 h 15'	0 h 45'	7 h 30'	

Analysis of Table 3.8.5

- **2005** – severe lack of satellite availability (actual $\Delta LST \sim 9$ h 10') in early afternoon (~ 13.30) and in night (~ 01.30);
- **2007** – severe lack of satellite availability (actual $\Delta LST \sim 7$ h 30') in early afternoon (~ 13.30) and in night (~ 01.30).

3.9 Comparative instrument performances

In addition to the coverage, the system also must provide homogeneous performances in terms of data quality, that depends on the instruments. *Table 3.9.1* compares the main features of imagers being operational in September 2005 and/or in 2007.

Table 3.9.1 – Comparative performances of imagers on-board sun-synchronous satellites

NOAA & Metop AVHRR/3		NPP VIIRS		Meteor-3M MR-2000M1 + Klimat		Meteor-M-1 MSU- MR		FY-1D & FY-3A MVISIR & VIRR		FY-3A MERSI	
λ	$\Delta\lambda$	λ	$\Delta\lambda$	λ	$\Delta\lambda$	λ	$\Delta\lambda$	λ	$\Delta\lambda$	λ	$\Delta\lambda$
		412 nm	20 nm							412 nm	20 nm
		445 nm	18 nm					455 nm	50 nm	443 nm	20 nm
										470 nm *	50 nm
		488 nm	20 nm					505 nm	50 nm	490 nm	20 nm
										520 nm	20 nm
		555 nm	20 nm					555 nm	50 nm	550 nm *	50 nm
										565 nm	20 nm
				↓ MR-2000-M1 ↓						650 nm	20 nm
630 nm	100 nm	640 nm *	80 nm	650 nm	200 nm	600 nm	200 nm	630 nm	100 nm	650 nm *	50 nm
		672 nm	20 nm							685 nm	20 nm
		700 nm *	400 nm								
		746 nm	15 nm							765 nm	20 nm
		865 nm	39 nm							865 nm	20 nm
862 nm	275 nm	865 nm *	39 nm					865 nm	50 nm	865 nm *	50 nm
								↓ FY-1/D	MVISIR ↓	905 nm	20 nm
						950 nm	300 nm	932 nm	65 nm	940 nm	20 nm
										980 nm	20 nm
		1240 nm	20 nm					↓ FY-3A	VIRR ↓	1030 nm	20 nm
		1378 nm	15 nm					1360 nm	70 nm		
		1610 nm	60 nm								
1610 nm	60 nm	1610 nm *	60 nm			1700 nm	200 nm	1600 nm	90 nm	1640 nm	50 nm
		2250 nm	50 nm							2130 nm	50 nm
		3.70 μm	0.18 μm								
3.74 μm	0.38 μm	3.74 μm *	0.38 μm			3.80 μm	0.6 μm	3.74 μm	0.4 μm		
		4.05 μm	0.16 μm								
		8.55 μm	0.30 μm								
10.80 μm	1.00 μm	10.76 μm	1.00 μm	↓ Klimat ↓		11.00 μm	1.00 μm	10.80 μm	1.00 μm		
		11.45 μm *	1.90 μm	11.5 μm	2.0 μm					11.25 μm *	2.50 μm
12.00 μm	1.00 μm	12.01 μm	0.95 μm			12.00 μm	1.00 μm	12.00 μm	1.00 μm		
6 channels		22 channels		2 channels		6 channels		10 channels		20 channels	
Swath: 2900 km		Swath: 3000 km		Swath: 3100 km		Swath: 3000 km		Swath: 2800 km		Swath: 2800 km	
IFOV: 1.1 km		IFOV: 800 m (* 400 m) ch. 700 nm: day/night		IFOV: VIS 1 km IR 3 km		IFOV: 1.0 km		IFOV: 1.1 km		IFOV: 1.0 km (* 250 m)	

It may be observed that there are three typologies of VIS/IR imagers:

- remaining models of previous series: MR-2000M1 + Klimat on Meteor-3M;
- AVHRR/3 on NOAA and Metop, MSU-MR on Meteor-M-1, MVISR on FY-1D;
- advanced imagers: VIIRS on NPP, MERSI+VIRR on FY-3/A.

In Fig. 3.8.1 the coverage from these different classes of instruments is marked by different colours (green: end-of-series instruments; blue: common current technology; red: advanced instruments).

It is observed from Fig. 3.8.1 that, in addition to the problem of the gap of coverage in the early-morning / late afternoon timeframes, there is the uneven distribution of advanced imagers in 2007, since the two satellites concerned, FY-3A and NPP, are in similar orbits (10.00 and 10.30 respectively).

Table 3.9.2 compares the main features of sounders being operational in September 2005 and/or in 2007. The Table collects information on the IR component (radiometer or spectrometer) and the MW component.

Table 3.9.2 – Comparative performances of sounders on-board sun-synchronous satellites

IR sounders				MW cross-track sounders					
NOAA & Metop HIRS/3 & HIRS/4		FY-3A IRAS		NOAA & Metop AMSU-A & AMSU-B / MHS		FY-3A MWTS & MWHS		NPP ATMS	
Central λ	Bandwidth	Central λ	Bandwidth	ν (GHz)	$\Delta\nu$ (MHz)	ν (GHz)	$\Delta\nu$ (MHz)	ν (GHz)	$\Delta\nu$ (MHz)
14.95 μm	3 cm^{-1}	14.95 μm	3 cm^{-1}	23.800	270			23.800	270
		14.80 μm	3 cm^{-1}	31.400	180			31.400	180
14.71 μm	10 cm^{-1}	14.71 μm	10 cm^{-1}	50.300	180	50.300	180	50.300	180
14.49 μm	12 cm^{-1}	14.49 μm	12 cm^{-1}					51.760	400
14.22 μm	16 cm^{-1}	14.22 μm	16 cm^{-1}	52.800	400			52.800	400
13.97 μm	16 cm^{-1}	13.97 μm	16 cm^{-1}	53.596 \pm 0.115	170	53.596 \pm 0.115	340	53.596 \pm 0.115	170
13.64 μm	16 cm^{-1}	13.64 μm	16 cm^{-1}	54.400	400			54.400	400
13.35 μm	16 cm^{-1}	13.35 μm	16 cm^{-1}	54.940	400	54.94	400	54.940	400
12.47 μm	16 cm^{-1}			55.500	330			55.500	330
11.11 μm	35 cm^{-1}	11.11 μm	35 cm^{-1}	$f_0 = 57.290344$	330	57.290	330	$f_0 = 57.290344$	330
9.71 μm	25 cm^{-1}	9.71 μm	25 cm^{-1}	$f_0 \pm 0.217$	78			$f_0 \pm 0.217$	78
		8.16 μm	25 cm^{-1}	$f_0 \pm 0.3222 \pm 0.048$	36			$f_0 \pm 0.3222 \pm 0.048$	36
7.33 μm	40 cm^{-1}	7.33 μm	40 cm^{-1}	$f_0 \pm 0.3222 \pm 0.022$	16			$f_0 \pm 0.3222 \pm 0.022$	16
6.52 μm	55 cm^{-1}	6.52 μm	80 cm^{-1}	$f_0 \pm 0.3222 \pm 0.010$	8			$f_0 \pm 0.3222 \pm 0.010$	8
4.57 μm	23 cm^{-1}	4.57 μm	23 cm^{-1}	$f_0 \pm 0.3222 \pm 0.0045$	3			$f_0 \pm 0.3222 \pm 0.0045$	3
4.52 μm	23 cm^{-1}	4.52 μm	23 cm^{-1}	89.000	2000			89.5	5000
4.47 μm	23 cm^{-1}	4.47 μm	23 cm^{-1}	89.0	1000				
4.45 μm	23 cm^{-1}	4.40 μm	23 cm^{-1}	150.0 (*)	1000	150.0	2000	165.5	3000
4.13 μm	28 cm^{-1}	4.20 μm	23 cm^{-1}	157.0 (**)	2800				
4.00 μm	35 cm^{-1}	4.00 μm	35 cm^{-1}	183.31 \pm 7.0 (*)	2000	183.31 \pm 7.0	2000	183.31 \pm 7.0	2000
3.76 μm	100 cm^{-1}	3.76 μm	100 cm^{-1}					183.31 \pm 4.5	2000
		1.64 μm	TBD	183.31 \pm 3.0	1000	183.31 \pm 3.0	1000	183.31 \pm 3.0	1000
		1.24 μm	TBD					183.31 \pm 1.8	1000
		0.94 μm	TBD	183.31 \pm 1.0	500	183.31 \pm 1.0	500	183.31 \pm 1.0	500
		0.885 μm	TBD	193.31 (**)	2200				
0.69 μm	1000 cm^{-1}	0.69 μm	1000 cm^{-1}						
		0.659 μm	TBD						
				(*) AMSU-B (**) MHS					
20 channels		26 channels		15 + 5 channels		4 + 5 channels		22 channels	
Swath: 2250 km		Swath: 2250 km		Swath: 2250 km		Swath: 2250 km		Swath: 2300 km	
IFOV: 18 km (HIRS-3) 10 km /HIRS-4)		IFOV: 17 km		IFOV: 48 km (AMSU-A) 16 km (AMSU-B)		IFOV: 70 km (MWTS) 15 km (MWHS)		IFOV: 32 km (temperature) 16 km (humidity)	

Advanced IR sounders			
Parameter	Metop IASI	NPP CrIS	Meteor-M-1 IRFS-2
Spectral range	3.62-15.5 μm (645-2760 cm^{-1})	3.92-15.4 μm (650-2550 cm^{-1})	5-15 μm (665-2000 cm^{-1})
Bands and spectral resolution	8.26-15.50 μm , 0.25 cm^{-1}	9.13-15.40 μm , 0.625 cm^{-1}	0.5 cm^{-1}
	5.00-8.26 μm , 0.25 cm^{-1}	5.71-8.26 μm , 1.25 cm^{-1}	
	3.62-5.00 μm , 0.25 cm^{-1}	3.92-4.64 μm , 2.5 cm^{-1}	
Channels	8460	1302	~ 4000
NEΔT	0.2-0.35 K @ 280 K	0.1-0.5 K @ 250 K	0.5 K @ 300 K

IFOV at s.s.p.	12 km	14 km	35 km
Sampling	2 x 2 IFOVs in 48 x 48 km ²	3 x 3 IFOVs in 48 x 48 km ²	1 IFOV in 100 x 100 km ²
Swath	2230 km (30 FOV's/scan)	2230 (30 FOV's/scan)	2000 km (20 FOV's/scan)

It may be observed that there are three typologies of sounding systems, depending on the IR component being a radiometer or a spectrometer, and the MW sounder being of the MSU or the AMSU class:

- TOVS-like: IRAS + MWTS + MWHS on FY-3A;
- ATOVS: HIRS + AMSU-A + AMSU-B/MHS on NOAA and Metop;
- advanced sounders: ATOVS + IASI on Metop, CrIS + ATMR on NPP, IRFS-2 + MTVZA on Meteor-M-1.

In Fig. 3.8.2 the coverage from these different classes of instruments is marked by different colours (green: TOVS-like; blue: ATOVS; red: advanced instruments).

It is observed from Fig. 3.8.2 that, in addition to the problem of the gap of coverage in the early-morning / late afternoon timeframes, there is the uneven distribution of advanced sounders in 2007, since the three satellites concerned, Meteor-M-1, Metop and NPP, are in similar orbits (09.15, 09.30 and 10.30 respectively).

Table 3.9.3 compares the main features of conical scanning MW radiometers being operational in September 2005 and/or in 2007.

Table 3.9.3 – Comparative performances of MW conical scanners (imagers and imaging/sounders)

FY-3A MWRI			Meteor-3M MIVZA			DMSP SSM/I			DMSP SSMIS			Meteor-3M & M-1 MTVZA		
v (GHz)	Δv (MHz)	Pol.	v (GHz)	Δv (MHz)	Pol.	v (GHz)	Δv (MHz)	Pol.	v (GHz)	Δv (MHz)	Pol.	v (GHz)	Δv (MHz)	Pol.

FY-3A MWRI			Meteor-3M MIVZA			DMSP SSM/I			DMSP SSMIS			Meteor-3M & M-1 MTVZA		
v (GHz)	Δv (MHz)	Pol.	v (GHz)	Δv (MHz)	Pol.	v (GHz)	Δv (MHz)	Pol.	v (GHz)	Δv (MHz)	Pol.	v (GHz)	Δv (MHz)	Pol.
~ 10	???	V,H												
~ 19	???	V,H				19.35	400	V,H	19.35	400	V,H	18.7	800	V,H
~ 22	???	V,H	20.0	???	???	22.235	400	V	22.235	400	V	22.235	1600	V
												33.0	2000	V,H
~ 37	???	V,H	35.0	???	V,H	37.0	1500	V,H	37.0	1500	V,H	36.5	2000	V,H
												42.0	2000	V,H
									50.3	400	H	48.0	2000	V,H
									52.8	400	H	52.80	400	V
									53.596	400	H	53.30	400	V
									54.4	400	H	53.80	400	V
												54.64	400	V
									55.5	400	H	55.63	400	V
									$f_0 = 57.29$	350	-	$f_0 = 57.29$		
									59.4	250	-	$f_0 \pm 0.3222 \pm 0.1$	50	H
									$f_1 = 60.792668$			$f_0 \pm 0.3222 \pm 0.05$	20	H
									$f_1 \pm 0.357892 \pm 0.050$	120	V+H	$f_0 \pm 0.3222 \pm 0.025$	10	H
									$f_1 \pm 0.357892 \pm 0.016$	32	V+H	$f_0 \pm 0.3222 \pm 0.01$	5	H
									$f_1 \pm 0.357892 \pm 0.006$	12	V+H	$f_0 \pm 0.3222 \pm 0.005$	3	H
									$f_1 \pm 0.357892 \pm 0.002$	6	V+H			
									$f_1 \pm 0.357892$	3	V+H			
									63.283248 ± 0.285271	3	V+H			
~ 90	???	V,H	94 GHz	???	V,H	85.5	3000	V,H	91.655	3000	V,H	91.65	3000	V,H
~150	???	V,H							150	1500	H			
									183.31 ± 6.6	1500	H	183.31 ± 7.0	1500	V
									183.31 ± 3.0	1000	H	183.31 ± 3.0	1000	V
									183.31 ± 1.0	500	H	183.31 ± 1.0	500	V
12 channels			5 channels			7 channels			24 channels			29 channels		
Swath: 1400 km			Swath: 1500 km			Swath: 1400 km			Swath: 1700 km			Swath: 2200 km		
..... km @ ~90 GHz		 km @ 94 GHz			12.5 km @ 85.5 GHz			12.5 km @ 91.655 GHz			17 km @ 91.65 GHz		

It may be observed that there are two typologies of MW conical scanners:

- imagers in window channels: SSM/I on DMSP, MWRI on FY-3A, MIVZA on Meteor-3M;
- imaging/sounders: SSMIS on DMSP, MTVZA on Meteor-3M and M-1.

In Fig. 3.8.3 the coverage from these different classes of instruments is marked by different colours (green: imagers; blue: imaging/sounders; red is reserved for advanced imaging/sounders, i.e. CMIS). In addition to the largest gaps in early afternoon and night, the figure shows that the coverage from DMSP-F16 (08.00) and Meteor-M-1 (09.15) are much overlapping.

4. R&D programmes of GOS interest

4.1 Generalities

The interest of GOS for R&D programmes, or single-launch satellites, or instruments on satellites, may stem from two motivations: i) the usefulness of data from R&D programmes/satellites/instruments in operational or research meteorology when they are being flown, even if long-term continuity is not guaranteed, data availability is not in real- or near-real time, and data quality is not fully characterised; and/or ii) the mission intends to provide demonstration of a new capability that can be later-on moved to an operational status.

It is reminded that the “*Implementation Plan for Evolution of Space and Surface-based Sub-systems of the GOS*” developed by the CBS Open Programme Area Group on the Integrated Observing Systems (OPAG-IOS) (WMO/TD No. 1267 dated April 2005), as concerns development in polar orbit of future operational interest has recommended the following:

- *LEO Doppler Winds - Wind profiles from Doppler lidar technology demonstration programme (such as Atmospheric Dynamics Mission - Aeolus) should be made available for initial operational testing; a follow-on long-standing technological programme is solicited to achieve improved coverage characteristics for operational implementation.*
- *GPM - The concept of the Global Precipitation Measurement Missions (combining active precipitation measurements with a constellation of passive microwave imagers) should be supported and the data realized should be available for operational use, thereupon, arrangements should be sought to ensure long-term continuity to the system.*
- *RO-Sounders - The opportunities for a constellation of radio occultation sounders should be explored and operational implementation planned. International sharing of ground network systems (necessary for accurate positioning in real time) should be achieved to minimize development and running costs.*
- *LEO MW - The capability to observe ocean salinity and soil moisture for weather and climate applications (possibly with limited horizontal resolution) should be demonstrated in a research mode (as with ESA’s SMOS and NASA’s OCE) for possible operational follow-on. Note that the horizontal resolution from these instruments is unlikely to be adequate for salinity in coastal zones and soil moisture on the mesoscale.*
- *LEO SAR - Data from SAR should be acquired from R&D satellite programmes and made available for operational observation of a range of geophysical parameters such as wave spectra, sea ice, land surface cover.*
- *LEO Aerosol - Data from process study missions on clouds and radiation as well as from R&D multi-purpose satellites addressing aerosol distribution and properties should be made available for operational use.*
- *Cloud Lidar - Given the potential of cloud lidar systems to provide accurate measurements of cloud top height and to observe cloud base height in some instances (stratocumulus, for example), data from R&D satellites should be made available for operational use.*
- *LEO Far IR - An exploratory mission should be implemented, to collect spectral information in the Far IR region, with a view to improve understanding of water vapour spectroscopy (and its effects on the radiation budget) and the radiative properties of ice clouds.*
- *Limb Sounders - Temperature profiles in the higher stratosphere from already planned missions oriented to atmospheric chemistry exploiting limb sounders should be made operationally available for environmental monitoring.*
- *Active Water Vapour Sensing - There is need for an exploratory mission demonstrating high-vertical resolution water vapour profiles by active remote sensing (for example by DIAL) for climate monitoring and, in combination with hyper-spectral passive sensing, for operational NWP.*

4.2 ESA programmes

ESA programmes have three activity lines:

- Earth Watch programmes, inclusive of their predecessor realisations;
- the ERS-1 / ERS-2 / Envisat programmes
- the Earth Explorer programme.

4.2.1 Earth Watch programmes

Earth Watch programmes are intended to develop operational series. Prior to formalising this activity as a “programme”, ESA had already developed:

- the *Meteosat Programme* (Meteosat-1/2/3, first launched in 1977) including launch and operations;
- the space segment of the *Meteosat Operational Programme (MOP)* (Meteosat-4/5/6/7, the last also known as *Meteosat Transition Programme* or *MTP*), was under the finance responsibility of EUMETSAT as from early 1987. The handover of operations from ESA to EUMETSAT took place in late 1995;
- the space segment of *Meteosat Second Generation (MSG)* (Meteosat-8 to be followed by 9/10/11) in partnership with EUMETSAT and providing *GERB* as an Announcement of Opportunity instrument for Meteosat-8.

Currently, ESA is cooperating with EUMETSAT for the definition of *Meteosat Third Generation (MTG)* in the framework of the Earth Watch programmes.

Information on all these components of the Meteosat programme is provided under Section 2.2.

As for the sunsynchronous orbit, ESA has already developed:

- the space segment of the three *Metop* satellites constituting the first series of the EUMETSAT Polar System (EPS) in partnership with EUMETSAT.

Information on the Metop/EPS programme is provided under Section 3.5.

Currently, ESA is cooperating with EUMETSAT for the definition of the *post-Metop programme* in the framework of the Earth Watch programmes.

Other Earth Watch programme elements are being proposed:

- A series of missions such as:
 - *TerraSAR*, for land observation by SAR in X-band (*TerraSAR-X*) and L-band (*TerraSAR-L*). The “consolidation programme” has been completed and continuation is to be discussed;
 - *FuegoSat*, prototype of a constellation for forest fire detection and monitoring. It has been redirected to become an element of GMES.
- The so-called “*Sentinels*” in the framework of the GMES (Global Monitoring for Environment and Security) space component:
 - *Sentinel-1*: provision of continuity of C-band SAR
 - *Sentinel-2*: land observation by superspectral imagery
 - *Sentinel-3*: observation of ocean circulation and surface status
 - *Sentinel-4*: atmospheric chemistry from geostationary orbit
 - *Sentinel-5*: atmospheric chemistry from sunsynchronous orbit.

A data-gap filler, to meet the most critical needs, called *GMES-1* is considered for the 2010-2011 time-frame.

4.2.2 The ERS 1/2 and Envisat programmes

After the initial involvement in meteorology, with Meteosat, ESA moved to multi-disciplinary programmes with *ERS (European Remote-sensing Satellite)*. After ERS-1, launched on 17 July 1991, the spare model was refurbished and improved with additional payload (*GOME*), and launched as ERS-2 in 1995.

Envisat (the largest Earth Observation satellite ever launched) is in fact a totally new programme but it is worth to list it in the same context of ERS since provides continuity to most of ERS instruments and closes a type of space mission approach (large multi-purpose satellites). The three satellites are 3-axis stabilised, placed in similar sunsynchronous orbits. **Table 4.2.1** records the chronology of ERS-1, ERS-2 and Envisat. **Fig. 4.2.1** and **Fig. 4.2.2** show the aspects of ERS-2 and Envisat respectively.

Table 4.2.1 – Chronology of ERS and Envisat (in bold the satellites active in Sept 2005)

Satellite	Launch	End of service	Height	LST	Status (Sept 2005)	Instruments
ERS-1	17 Jul 1991	10 Mar 2000	785 km	10.30	Inactive	AMI, RA, ATSR, MWR, LRR, PRARE
ERS-2	21 Apr 1995	expected ≥ 2006	785 km	10.30	Operational	AMI, RA, ATSR-2, MWR, GOME, LRR, PRARE
Envisat	1 Mar 2002	expected ≥ 2007	800 km	10.00	Operational	ASAR, RA-2, AATSR, MWR, MERIS, MIPAS, GOMOS, SCIAMACHY, LRR, DORIS

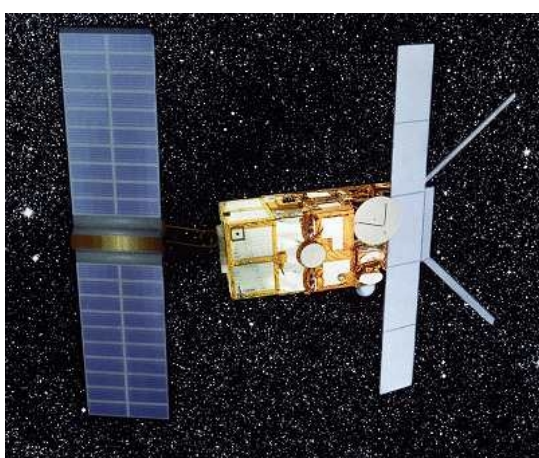

Fig. 4.2.1 – Sketch view of ERS-2.

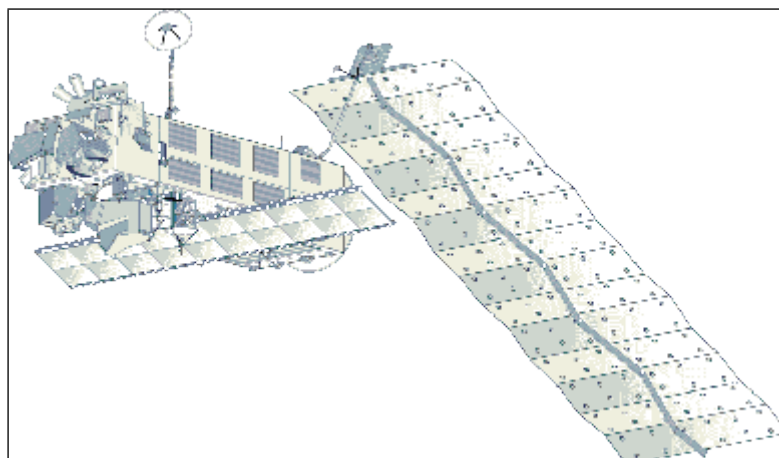

Fig. 4.2.2 - Sketch view of Envisat.

ERS-2 is still operating after 10 years from launch. All instruments are working, but the global on-board recording failed in June 2003, so now data is available only on ESA station's visibility. In one overlapping period with ERS-1 (9 months across 1995-1996) the two satellites were operated in "tandem" mode to increase the frequency of coverage and provide a large dataset for SAR interferometry (e.g., for Digital Elevation Model updating).

Envisat is operating with most instruments working at nominal performance. Exceptions: some degradation of *MIPAS* and *GOMOS*.

Payload of ERS-2 (including all of ERS-1 + ATSR improvement and addition of GOME)

- **AMI (Active Microwave Instrument):** a C-band (5.3 GHz) package that shares operations among:
 - imaging **SAR (Synthetic Aperture Radar)**, swath 100 km, resolution 30 m, duty cycle 12 %;
 - **wind scatterometer (SCAT)**, swath 500 km, resolution 50 km (sampling 25 km), duty cycle any time when the SAR imaging mode in not active, thus up to 88 %;
 - **SAR wave mode**, activated each 200 or 300 km, to observe 5 x 5 km² *imagettes* of 30 m resolution where spectra of the echoes are retrieved to determine wave power, direction and length; duty cycle 70 %, possible simultaneously with the SCAT mode.
- **RA (Radar Altimeter):** a Ku-band radar (13.8 GHz) to measure significant wave height, wind speed, ocean topography and ice topography; nadir-pointing, resolution 20 km along-track.
- **MWR (Micro-Wave Radiometer):** two-frequency radiometer (23.8 and 36.5 GHz) to measure total-column water vapour over the ocean necessary to provide wet tropospheric path delay correction for RA; nadir-pointing, resolution 20 km along-track.

- **ATSR-2 (Along-Track Scanning Radiometer - 2)**: 7-channel VIS/IR radiometer (4-channels in ERS-1/ATSR) for multi-purpose imagery (with special emphasis on very accurate sea-surface temperature); swath 500 km, conical scanning for cross-nadir and forward views, resolution 1 km.
- **GOME (Global Ozone Monitoring Experiment)**: 4096-channel grating spectrometer. Spectral range 240-790 nm with spectral resolution 0.2 nm in UV and 0.4 nm in VIS. Tracked species: O₃, O₂, O₄, NO, NO₂, NO₃, H₂O, BrO, ClO, OClO, HCHO, SO₂ and aerosol. Resolution 40 km along-track, 320 km cross-track for a 960 km swath or 40 km for a 120 km swath.
- **PRARE (Precise Range And Range-rate Equipment)** and **LRR (Laser Retro-Reflector)**: for precision orbit determination, specifically useful for the topographic applications of RA.

Instruments sheets are provided in Annex A3.2 for AMI, RA, MWR, ATSR-2 and GOME.

Payload of Envisat

- **ASAR (Advanced Synthetic Aperture Radar)**: still operating in C-band (5.3 GHz). In the “*stripmap mode*” it operates similarly to the ERS-1/2 SAR, except that the 100 km swath may be selected among 7 possibilities within a viewing area of 485 km, the polarisation may be either HH or VV, and the “*wave mode*” is activated at 100 km intervals. The resolution is still 30 m. In the “*scanSAR mode*” more modes are available:
 - *alternating polarisation* over the same image strips of the strip map mode
 - *wide swath* over 405 km with resolution degraded to 150 m
 - *global monitoring* over 405 km swath with 1 km resolution, active > 70 % of the time whereas all other modes (stripmap, alternating polarisation, wider swath) can only be active < 30 %.
- **RA-2 (Radar Altimeter - 2)**: improved over ERS-1/2 RA by complementing the basic Ku-band frequency (13.6 GHz) by an S-band frequency (3.2 GHz) for better atmospheric corrections.
- **AATSR (Advanced Along-Track Scanning Radiometer)**, re-designed after the ERS-2 ATSR-2.
- **MERIS (Medium Resolution Imaging Spectrometer)**: 15-channel VIS/NIR spectroradiometer for ocean colour, vegetation and aerosol; swath 1500 km, resolution 300 m or 1200 m.
- **MWR (Micro-Wave Radiometer)**, re-designed after the ERS-1/2 MWR.
- **MIPAS (Michelson Interferometer for Passive Atmospheric Sounding)**: limb-scanning interferometer for atmospheric chemistry. Spectral range 4.15-14.6 μm with spectral resolution 0.035 cm⁻¹. Tracked species: O₃, NO, NO₂, HNO₃, HNO₄, N₂O₅, ClONO₂, COF₂, HOCl, CH₄, H₂O, N₂O, CFC's (F11, F12, F22, CCl₄, CF₄), CO, OCS, C₂H₂, C₂H₆, SF₆ and aerosol. Vertical resolution 3 km in the range 5-150 km
- **GOMOS (Global Ozone Monitoring by Occultation of Stars)**: limb-viewing grating spectrometer for atmospheric chemistry by occultation of 25-40 stars per orbit. Spectral range 250-950 nm with spectral resolution 0.89 nm (UV/VIS) and 0.12 nm (NIR). Tracked species: O₃, H₂O, NO₂, NO₃, OClO, BrO, ClO and aerosol. Vertical resolution 1.7 km in the range 20-100 km.
- **SCIAMACHY (Scanning Imaging Absorption Spectrometer for Atmospheric Cartography)**: grating spectrometer for atmospheric chemistry exploiting both limb and cross-nadir scanning. Spectral range 240-2380 nm with spectral resolution 0.24 to 1.48 nm. Tracked species: O₃, O₂, O₄, NO, NO₂, NO₃, N₂O, CO, CO₂, CH₄, H₂O, BrO, ClO, OClO, HCHO, SO₂ and aerosol. Vertical resolution (limb mode) 3 km in the range 10-100 km, horizontal resolution (cross-nadir mode) 16 x 32 km² over a 1000 km swath.
- **DORIS (Doppler Orbitography and Radiopositioning Integrated by Satellite)** and **LRR (Laser Retro-Reflector)**: for precision orbit determination, especially useful for the topographic applications of RA-2 and limb sounders' navigation.

Instrument sheets are provided in Annex A3.2 for ASAR, RA-2, MERIS, MIPAS, SCIAMACHY and GOMOS, in addition to those of AATSR (= ATSR-2) and MWR provided under ERS-2.

Data availability for the purpose of GOS

An Announcement of Opportunity (AO) specific for the use of ERS and Envisat data for WMO members was released in January 2003. Proposals can also be submitted at any time through the ESA web site (see detailed information at eopi.esa.int).

Several data from ERS-2 and Envisat are available in Near-Real-Time (NRT), i.e. within 3 h from data acquisition, for the purpose of operational meteorology.

Early since ERS-1, low-bit-rate data (significant wave height and wind speed from *RA*, sea-surface winds from *AMI-SCAT*, wave spectra from *AMI-Wave*) are distributed, BUFR-coded, via the Global Telecommunication System (GTS) through the Rome Regional Telecommunication Hub (RTH) of the Italian Meteorological Service.

During the lifetime of ERS-2, *GOME* data centralisation and processing times have been gradually reduced, so that products such as ozone total-column are now made available in NRT on ftp sites from the German space agency (DLR) and the Dutch Meteorological Institute (KNMI).

For Envisat, a BUFR-coded “meteorological package” is made freely available in NRT on ftp servers (password needed). The package includes: significant wave height and wind speed from *RA-2* + *MWR*, wave spectra from *ASAR-wave*, sea-surface temperatures from *AATSR*, cloud thickness and water vapour from *MERIS*, ozone profiles from *GOMOS* and columnar amounts of several trace gases from *SCIAMACHY*.

The other (high-rate) data are available from the network of Processing & Archiving Facilities (PAF, for ERS) or Centres (PAC, for Envisat) of the ERS/Envisat Ground Segment.

4.2.3 The Earth Explorer programme

The Earth Explorer programme is a framework designed to develop single missions, either small (“opportunity missions”) or medium (“core missions”). The mission purposes address the study of a particular process, or the demonstration of a new observation capability. Core missions are selected following a “Call for Ideas”, Opportunity mission are selected following a “Call for Proposal”. So far, two Calls for Ideas have been processed, and one is in progress; and two Calls for Proposals. **Table 4.2.2** provides essential information on the missions so far selected (in order of expected launch date):

- *CryoSat* (“opportunity mission”)
- *GOCE (Gravity Field and Steady-State Ocean Circulation Explorer)* (“core mission”)
- *SMOS (Soil Moisture and Ocean Salinity)* (“opportunity mission”)
- *ADM-Aeolus (Atmospheric Dynamics Mission - Aeolus)* (“core mission”)
- *Swarm (The Earth’s Magnetic Field and Environment Explorers)* (“opportunity mission”)
- *Earth-CARE (Earth Clouds, Aerosol and Radiation Explorer)* (“core mission”)

Table 4.2.2 – List of selected Earth Explorer missions as of mid-2005

Satellite	Launch	Life	Orbit	Main instruments	Mission
CryoSat	8 Oct 2005 (failed)	-	Non-sunsynchronous, 717 km, inclination 92°	SIRAL (SAR/Interferometric Radar Altimeter)	Ice thickness and topography
GOCE	nov-2006	1.3 y	Sunsynchronous, 250 km, LST 06/18	Gravity Gradiometer, 12-channel GPS receiver	Gravity field anomalies and accurate geoid
SMOS	feb-2007	≥ 3 y	Sunsynchronous, 763 km, LST 06/18	MIRAS (Microwave Imaging Radiometer using Aperture Synthesis)	Large-scale salinity and soil moisture
ADM-Aeolus	sep-2008	3 y	Sunsynchronous, 400 km, LST 06/18	ALADIN (Atmospheric Laser Doppler Instrument)	Wind profile in clear air
Swarm (3 satellites)	mid-2009	4.5 y	2 sats at 450 km, 87.4° 1 sat at 530 km, 86.8°	Magnetometers (scalar and vector), Electric Field, Accelerometer	Earth interior through geomagnetic field

Earth-CARE	2012	2-3 y	Sunsynchronous, 450 km, LST 10:30	ATLID (Atmospheric Lidar), CPR (Cloud Profiling Radar), MSI (Multi-Spectral Imager), BBR (Broad-Band Radiometer)	Cloud microphysics, radiation, aerosol
-------------------	------	----------	--------------------------------------	---------------------------------------------------------------------------------------------------------------------------	----------------------------------------------

Data from Earth Explorer missions may be released for use within the GOS. Specifically, ADM-Aeolus data will need intensive evaluation in view of a possible operational follow-on. Data from SMOS and Earth-CARE also could be used to improve modelling and parameterisation in NWP.

4.3 NASA programmes

The number of Earth Observation NASA programmes or missions is very large. We limit this report to those that have or have had largest impact on the evolution of the Global Observing System (GOS). The selection, somewhat disputable, includes:

- the Nimbus programme, SeaSat, ERBS, UARS;
- the Landsat programme;
- the EOS programme;
- the Earth System Science Pathfinder programme;
- a selection of other missions relevant for GOS.

The TIROS programme has been reported as precursor of NOAA/POES under Section 3.2, the ATS programme as precursor of GOES under Section 2.3. NASA assists NOAA for installing the POES and GOES satellites and is partner of NOAA and the DoD for implementing NPOESS (Section 3.4).

4.3.1 The Nimbus programme, SeaSat, ERBS and UARS

In this Section we collect historical information on those large R&D programmes that have been basic for testing remote sensing principles and demonstrating instrumentation thereafter utilised in operational programmes. *Table 4.3.1* reports the chronology of the Nimbus, SeaSat, ERBS and UARS programmes. *Fig. 4.3.1* and *Fig. 4.3.2* show the aspects of Nimbus-7 and UARS respectively.

Table 4.3.1 – Chronology of Nimbus, SeaSat, ERBS and UARS satellites

Satellite	Launch	End of service	Height	LST / incl.	Instruments
Nimbus-1	28 Aug 1964	23 Sep 1964	680 km	12:00	HRIR, AVCS, APT
Nimbus-2	15 May 1966	17 Jan 1969	1140 km	11:30	HRIR, AVCS, APT, MRIR
Nimbus-3	13 Apr 1969	22 Jan 1972	1100 km	12:00	HRIR, IDCS, MRIR, IRIS-B, SIRS, MUSE, IRLS
Nimbus-4	8 Apr 1970	30 Sep 1980	1100 km	12:00	THIR, IDCS, IRIS-D, SIRS-B, FWS, SCR, MUSE, BUV, IRLS
Nimbus-5	10 Dec 1972	29 Mar 1983	1100 km	12:00	THIR, SCMR, ESMR, ITPR, SCR, NEMS
Nimbus-6	12 Jun 1975	29 Mar 1983	1100 km	12:00	THIR, ESMR, HIRS, PMR, SCAMS, LRIR, ERB, TWERLE
Nimbus-7	24 Oct 1978	????? 1994	947 km	12:00	THIR, CZCS, SMMR, LIMS, SAM-II, SAMS, SBUV, TOMS, ERB
SeaSat	27 Jun 1978	10 Oct 1978	785 km	108°	SAR, SMMR, ALT, SASS, VIRR, LTR
ERBS	5 Oct 1984	????????	610 km	57°	ERBE, SAGE-II
UARS	12 Sep 1991	????? 2005	700 km	57°	CLAES, ISAMS, HALOE, MLS, SOLSTICE, SUSIM, HRDI, WINDII, ACRIM-2, PEM

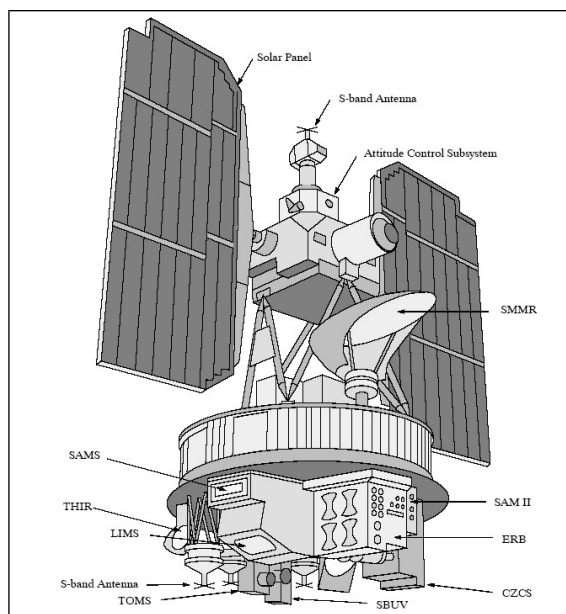

Fig. 4.2.1 – Sketch view of Nimbus-7.



Fig. 4.2.2 - Sketch view of UARS.

4.3.1.1 Instrument evolution through the Nimbus programme

The Nimbus programme was the engine of proof-of-concepts and instrument development in support of the meteorological operational systems. We provide here a shortest review of the full instruments list.

Evolution of VIS/IR imagers

- **APT (Automatic Picture Transmission)** [Nimbus-1/2], and thereafter **IDCS (Image Dissector Camera System)** [Nimbus-3/4], were single-channel (VIS) cameras, resolution 2.5 km s.s.p., swath 2200 km, with real-time transmission capability that established a standard for certain aspects still valid nowadays. It was then used in ESSA satellites.
- **AVCS (Advanced Vidicon Camera System)** [Nimbus-1/2] had higher resolution (0.9 km s.s.p.) and 3500 km swath achieved by three side-to-side cameras. It was then used on ESSA satellites.
- **HRIR (High Resolution Infrared Radiometer)** [Nimbus-1/2/3] introduced cross-track mechanical scanning for IR imagery. Single channel (3.5-4.1 μm), resolution 9 km s.s.p., effective swath 3000 km, real-time transmission capability. On Nimbus-3 a second channel was added (0.7-1.3 μm).
- **THIR (Temperature-Humidity Infrared Radiometer)** [Nimbus-4/5/6/7] had two channels, 6.5-7.0 μm (resolution 22 km s.s.p.) and 10.5-12.5 μm (resolution 8 km s.s.p.), effective swath 3000 km, real-time transmission on Nimbus-4 (discontinued on Nimbus 5/6/7).
- **SCRM (Surface Composition Mapping Radiometer)** [Nimbus-5], designed for distinguishing acidic and basic rocks, soils and sediments, had three channels, 0.8-1.1 μm , 8.3-9.3 μm and 10.2-11.2 μm ; resolution 660 m s.s.p., swath 800 km.
- **CZCS (Coastal Zone Colour Scanner)** [Nimbus-7], prototype of follow-on instruments for ocean colour monitoring, had 6 channels centred on 0.443, 0.52, 0.55, 0.67, 0.75 and 11.5 μm , resolution 825 m s.s.p., swath 1600 km.

Evolution of MW imagers

- **ESMR (Electrically Scanning Microwave Radiometer)** [Nimbus-5/6] on Nimbus-5 was working at 19.35 GHz, best suited for ocean ice and heavy precipitation over ocean, with resolution 25 km s.s.p. and swath 3100 km electrically scanned. On Nimbus-6 the frequency was changed to 37 GHz, more suitable for snow mapping and sensitive to light rain. Two polarisations were provided by conical (still electrical) scanning, with resolution 30 km (quadratic average) and swath 1270 km.

- **SMMR (Scanning Multichannel Microwave Radiometer)** [Nimbus-7] was a conical mechanical scanning radiometer with 5 frequencies (6.6, 10.7, 18, 21 and 37 GHz) all in double polarisation. Resolution (quadratic average) ranging from 22 km at 37 GHz to 120 km at 6.6 GHz, swath 780 km.

Evolution of IR sounders

- **IRIS (Infra-Red Interferometer Spectrometer)** [Nimbus-3/4] placed the foundation not only for the IR sounding mission, but also for the selection of channels for IR imagers. On Nimbus-3 the spectral range was 5-20 μm and the spectral resolution 2.5 cm^{-1} (unapodised); on Nimbus-4 the spectral range was 5-25 μm and the spectral resolution 1.4 cm^{-1} (unapodised). Nadir-only viewing, with resolution 150 km (Nimbus-3) or 94 km (Nimbus-4).
- **SIRS (Satellite Infra-Red Spectrometer)** [Nimbus-3/4] was differing from IRIS in so far as it was aiming at a more robust configuration suitable for future operational concepts. Though based on a grating spectrometer, a relatively small number of radiometric channels were drawn: in Nimbus-3, 8 channels in the range 11-15 μm , in Nimbus-4 further 6 channels were added, in the rotational band of water vapour, 18-36 μm . The resolution was 220 km, nadir-only in Nimbus-3, with 3 cross-track spots for Nimbus-4 (total swath 1800 km).
- **FWS (Filter Wedge Spectrometer)** [Nimbus-4] experienced the spectral scan method based on alternating filters, still in use on the current *HIRS* of POES and Metop. Two bands, 3.2-6.4 μm and 1.2-2.4 μm , spectral resolution 0.6-1.2 %, horizontal resolution 70 km, nadir-only view.
- **ITPR (Infrared Temperature Profile Radiometer)** [Nimbus-5] used parallel telescopes for better radiometric budget and higher resolution (36 km s.s.p. over a 1700 km swath). Seven channels in the range 3.7-19.7 μm , bandwidth around 2 %.
- **HIRS (High-resolution Infra-Red Sounder)** [Nimbus-6], embarked in 1975, is still in use on POES and Metop satellites after several upgradings. At that time it had 16 IR channels covering the range 3.7-15 μm + 1 VIS channel, bandwidths around 1 %, 24 km resolution, 1800 km swath.
- **SCR (Selective Chopper Radiometer)** [Nimbus-4/5] was designed for profiles in the stratosphere, using filter cell differently pressurised so as to change the height of the weighting function peak. On Nimbus-4 there were 6 channels around 15 μm , resolution 130 or 220 km; on Nimbus-5 16 channels including the rotational water vapour band up to 50 μm , resolution 29 or 42 km. Nadir-only view.
- **PMR (Pressure Modulator Radiometer)** [Nimbus-6] was an upgrade of *SCR*, changing the height of the weighting function peak between 40 and 90 km by modulating the pressure in only two cells. It was the predecessor of the *SSU (Stratospheric Sounding Unit)* operationally flown up to NOAA-14. Resolution 500 km, nadir-only view.

Evolution of MW sounders

- **NEMS (Nimbus-E Microwave Sounder)** [Nimbus-5] had five channels, 3 in the 54 GHz band, then 22.2 and 31.4 GHz. Resolution 190 km, nadir-only view.
- **SCAMS (Scanning Microwave Spectrometer)** [Nimbus-6] had the same channels as NEMS, but cross-nadir scanning capability; resolution 145 km s.s.p., swath 2400 km. It was the predecessor of *MSU (Microwave Scanning Unit)* operationally flown up to NOAA-14.

Radiometers for earth radiation budget

- **MRIR (Medium Resolution Infrared Radiometer)** [Nimbus-2/3] had 5 channels, two broad-band (0.2-4.0 μm and 5-30 μm), three narrow-band (6.4-6.9 μm , 10-11 μm and 14-16 μm), to observe integrated short-wave (SW) and long-wave (LW) radiation from Earth to Space and its main components (water vapour, window, CO_2). Resolution 55 km s.s.p., swath 3000 km. On Nimbus-3 the LW channel was replaced by 20-23 μm .
- **ERB (Earth Radiation Budget)** [Nimbus-6/7] had 10 SW channels between 0.243 and 5.0 μm to measure incoming solar radiation, 4 non-scanning wide-angle (3300 km centred on nadir) earth-viewing channels between 0.2 and 50 μm , and 8 scanning channels for multi-angle observation (4 in SW, 4 in LW) with resolution 80 km s.s.p. over the 3300 km swath.

UV monitoring

- **BUV (Backscatter Ultraviolet Spectrometer)** [Nimbus-4] was measuring UV backscattered radiation in 12 narrow-band channels (1 nm) between 250 and 340 nm to derive ozone total-column and gross profile. Resolution 220 km, nadir-only view. **SBUV (Solar Backscatter Ultraviolet Spectrometer)** [Nimbus-7] was quite similar, and through several updating is still been used on POES satellites.
- **TOMS (Total Ozone Mapping Spectrometer)** [Nimbus-7] had 6 channels in the range 310-380 nm, 1 nm bandwidth, for total-column ozone. Resolution 50 km, swath 2700 km. It was re-flown on Meteor-3-6 (1991) and ADEOS-1 (1996), and as a dedicated mission (**TOMS Earth Probe**, 1996).
- **MUSE (Monitor of Ultraviolet Solar Energy)** [Nimbus-3/4] was measuring incoming solar radiation at 5 wavelengths in the range 115-300 nm during the sun occultation at each orbit.

Limb sounders

- **LRIR (Limb Radiance Inversion Radiometer)** [Nimbus-6] was a 4-channel radiometer measuring temperature (two channels in the 15 μm band), ozone (9.6 μm) and water vapour (25 μm) in the range 15-60 km, with vertical resolution 3 km. **LIMS (Limb Infrared Monitor of the Stratosphere)** [Nimbus-7] was the *LRIR* evolution, moving the water vapour channel from 25 with 6.2 μm and adding two channels, one for NO_2 (6.3 μm), one for HNO_3 (11.3 μm).
- **SAMS (Stratospheric and Mesospheric Sounder)** [Nimbus-7] was measuring profiles of temperature, water vapour, CH_4 , CO , N_2O and NO , and by exploiting the filter cell pressure modulation technique of *SCR* and *PMR* in the limb geometry. There were 8 channels in the range 2.7-15 μm + one in the range 25-100 μm . Vertical resolution 5 km in the range 15-140 km.
- **SAM-II (Stratospheric Aerosol Measurement - II)** [Nimbus-7] was measuring aerosol profiles by sun occultation in a single channel at 1.0 μm . Vertical resolution 1 km in the range 10-40 km.

Data collection missions

- **IRLS (Interrogation, Recording and Location System)** [Nimbus-3/4] and **TWERLE (Tropical Wind Energy-conversion and Reference Level Experiment)** [Nimbus-6] were data collection (upon interrogation) and location systems. The *TWERLE* mission was associated to 300 floating balloons.

4.3.1.2 The SeaSat mission

SeaSat only lasted 106 days in orbit (70 useful for data generation), but this was sufficient to demonstrate the capabilities of active MW in all modes: SAR, altimetry, scatterometry. Instruments:

- **SAR (Synthetic Aperture Radar)**, first SAR in space, used L-band (1.275 GHz); swath 100 km, resolution 25 m, duty cycle %;
- **ALT (Radar Altimeter)** was a Ku-band radar (13.5 GHz) to measure significant wave height, wind speed, ocean topography and ice topography; nadir-pointing, resolution 12 km along-track. It was supported by **LTR (Laser Tracking Reflector)** for precision orbit determination.
- **SASS (SeaSat-A Scatterometer System)** was a Ku-band radar (14.6 GHz) for sea-surface winds; swath 1000 km (two side strips each 500 km wide), resolution 50 km.
- **SMMR (Scanning Multichannel Microwave Radiometer)**, same as on Nimbus-7, with resolution and swath scaled by a factor 700/950, consequence of different heights.
- **VIRR (Visible and Infra-Red Radiometer)**, supportive of the MW passive and active instruments, had two channels, 0.49-0.94 μm (resolution 2.3 km s.s.p.) and 10.5-12.5 μm (resolution 4.4 km s.s.p.), swath 3000 km.

4.3.1.3 The ERBS mission

ERBS (Earth Radiation Budget Satellite) performed a coordinated mission with NOAA-9 (1984-1998) in p.m. orbit and NOAA-10 (1986-2001) in a.m. orbit. It was in a drifting orbit to cover all Local Solar Times (LST's) during the year. It carried two instruments:

- **ERBE (Earth Radiation Budget Experiment)**, derived from *ERB*. The non-scanning channels had wide-angle (2000 km) and medium-angle (110 km). The scanning channels had resolution 40 km.
- **SAGE-II (Stratospheric Aerosol and Gas Experiment - II)**, follow-on of the NIMBUS-7 *SAM-II*, operating in limb-mode during sun or moon occultation. 7-channel radiometer in the range 0.385-1.020 μm . Vertical resolution 1 km in the range 10-40 km. A **SAGE-III** follow-on was embarked on Meteor-3M-N1 (see Section 3.6) and instrument template in Annex A3.1.

4.3.1.4 The UARS mission

UARS (Upper Atmosphere Research Satellite) was mostly addressing atmospheric chemistry and dynamics in the stratosphere and mesosphere. When launched (1991) was by far the largest Earth Observation satellite ever in orbit (6800 kg). Instruments:

- **CLAES (Cryogenic Limb Array Etalon Spectrometer)** operating in four spectral ranges, 3.5, 6, 8 and 12.7 μm to observe CF_2Cl_2 , CF_4 , CFCl_3 , CH_4 , ClO , ClONO_2 , CO_2 , H_2O , HCl , HNO_3 , N_2O , NO , NO_2 , O_3 and temperature. Limb sounder with vertical resolution 2.5 km in the range 10-60 km.
- **ISAMS (Improved Stratospheric and Mesospheric Sounder)**, successor of *SAMS* on Nimbus-7. Now 8 channels in the range 4.6-16.6 μm . Species: CH_4 , CO , H_2O , HNO_3 , N_2O , N_2O_5 , NO , O_3 and aerosol. Limb sounder with vertical resolution 2.4 km in the range 15-140 km.
- **HALOE (Halogen Occultation Experiment)**, gas filter correlation spectrometer working in sun occultation in the range 2.43-10.25 μm . Species: CH_4 , H_2O , HCl , HF , NO , NO_2 , O_3 and pressure. Limb sounder with vertical resolution 1.6 km in the range 10-40 km.
- **MLS (Microwave Limb Sounder)** operating in three bands at frequencies 63 GHz, 183 GHz (2 channels) and 205 GHz (3 channels). Species: ClO , H_2O , H_2O_2 , O_3 and pressure. Limb sounder with vertical resolution 4 km in the range 5-85 km.
- **SOLSTICE (Solar/Stellar Irradiance Comparison Experiment)**, grating spectrometer to compare solar and stellar irradiance in the range 115-430 nm with spectral resolution 0.12-0.25 nm.
- **SUSIM (Solar Ultraviolet Spectral Irradiance Monitor)**, dispersion spectrometer to measure solar irradiance in the range 120-400 nm with spectral resolution 0.1 nm.
- **HRDI (High-Resolution Doppler Imager)**, 13-bands Fabry-Perot interferometer operating in the 557-776 nm range with spectral resolution 0.05 cm^{-1} to measure stratospheric winds by Doppler shift of O_2 lines. Limb sounder with vertical resolution 2.5 km in the range 10-115 km.
- **WINDII (Wind Doppler Imaging Interferometer)**, a Michelson interferometer measuring Doppler shift and broadening of several lines of ionised and molecular oxygen and OH in the 557-764 nm range with spectral resolution $\dots \text{ cm}^{-1}$. Limb sounder with vertical resolution 20 km in the range 80-300 km.
- **ACRIM-2 (Active Cavity Radiometer Irradiance Monitor)** to measure total solar irradiance.
- **PEM (Particle Environment Monitor)** to *in situ* monitor charged particles and magnetic field.

4.3.2 The Landsat programme and follow-on

The first land observation satellite, initially named *ERTS (Earth Resources Technology Satellite)*, thereafter re-named **Landsat-1**, was launched in 1972. It was followed by further 6 flight models that, in practise, provided nearly-uninterrupted service till nowadays. **Table 4.3.2** reports the chronology of the Landsat programme and follow-on activities. **Fig. 4.3.3** shows the aspect of Landsat-7. It is noted that the ~ 900 km height of Landsat 1 to 3 provides a repeat cycle of 18 days whereas the ~ 700 km height of Landsat 4 to 7 provides a 16-day repeat cycle.

Table 4.3.2 – Chronology of the Landsat programme (in bold the satellites active in Sept 2005)

Satellite	Launch	End of service	Height	LST	Status (Sept 2005)	Instruments
Landsat-1 (ERTS)	23 Jul 1972	2 Jan 1978	907 km	10:00	Inactive	RBV, MSS, DCS

Landsat-2	22 Jan 1975	25 Feb 1982	908 km	10:00	Inactive	RBV, MSS, DCS
Landsat-3	5 Mar 1978	31 Mar 1983	915 km	10:00	Inactive	RBV, MSS, DCS
Landsat-4	16 Jul 1982	????? 1993	705 km	10:00	Inactive	MSS, TM, GPS
Landsat-5	1 Mar 1984	?????????	705 km	10:00	?????????	MSS, TM, GPS
Landsat-6	5 Oct 1993	Failed at launch	-	-	Inactive	ETM
Landsat-7	15 Apr 1999	expected ≥ 2006	705 km	10:00	Operational	ETM+
NMP EO-1	21 Nov 2000	?????????	705 km	10:15	?????????	ALI, LEISA, Hyperion
LDCM	~ 2010	N/A	TBD	TBD	Being studied	OLI

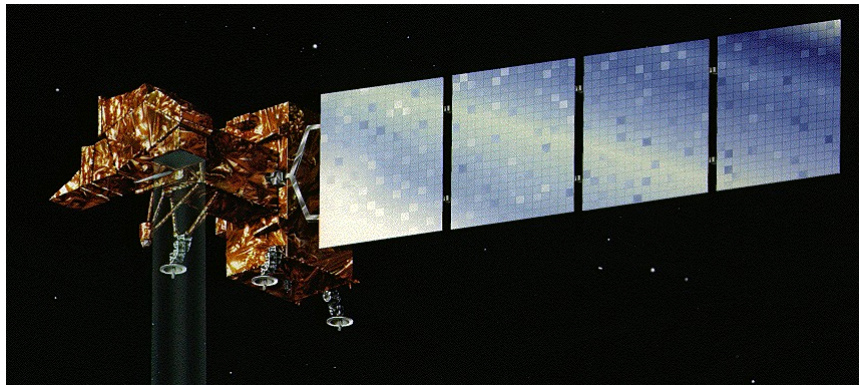

Fig. 4.3.3 – Sketch view of Landsat-7.

Landsat instruments

- ***RBV (Return-Beam Vidicon camera)*** [Landsat-1/2/3] consisted in three co-aligned cameras, one for each channel centred on 0.53, 0.63 and 0.76 μm respectively. Frames of 185 x 185 km^2 , resolution 40 m.
- ***MSS (Multi-Spectral Scanner)*** [Landsat-1/2/3] was a 4-channel radiometer (0.55, 0.65, 0.75 and 0.95 μm). Swath 185 km, resolution 80 m.
- ***TM (Thematic Mapper)*** [Landsat-4/5] had 7 channels, 6 in SW (0.48, 0.56, 0.66, 0.83, 1.65, 2.20 μm) with resolution 30 m, one in IR (10.4-12.5 μm) with resolution 120 m. Swath 185 km.
- ***ETM (Enhanced Thematic Mapper)*** [Landsat-6] was similar to *TM*, but a panchromatic channel (0.5-0.9 μm) was added, with resolution 15 m.
- ***ETM+ (Enhanced Thematic Mapper +)*** [Landsat-7] is similar to *ETM*, but the resolution of the IR channel has been improved to 60 m.
- ***DCS (Data Collection System)*** [Landsat-1/2/3] was to receive and relay data from ground-based stations.
- ***GPS (Global Positioning System)*** [Landsat-4/5] was a receiver for precise navigation and orbit determination.

An ***LDCM (Landsat Data Continuity Mission)*** is now being defined. It could consist of a new satellite series or on flying instruments on other satellites (e.g., NPOESS). The notion has been introduced of:

- ***OLI (Operational Land Imager)***, similar to *ETM+* except that the IR channel is dropped and three channels are added (0.44, 0.87 and 1.25 μm). The resolution of the panchromatic channel is 10 m.

The technology for *OLI* will take benefit of the ***NWP EO-1 (New Millennium Program – Earth Observing -1)*** mission, that has developed extremely advanced technologies for more performing and less resource-demanding instruments. This instruments are:

- ***ALI (Advanced Land Imager)***, the prototype of *OLI*. As compared to *ETM+*, mass and electrical power are reduced by a factor 4.
- ***LEISA (Linear Etalon Imaging Spectrometer Array)***, supportive of *ALI* for providing atmospheric correction: same 185 km swath, 250 m resolution, spectral coverage 0.89-1.6 μm with spectral resolution 2-6 nm.
- ***Hyperion***, an hyperspectral imager with 220 channels of 10 nm bandwidth in the range 0.4-2.5 μm , resolution 30 m over a narrow 7.5 km swath.

Instrument sheets from this Section 4.3.2 are provided for *ETM+*, the only instrument currently operating, and *OLI*, that seems to be sufficiently defined.

For the purpose of data access in support of GOS, Landsat data can be received in real-time only by appointed ground station. Otherwise, data are distributed by the ***EROS Data Centre (EDC) of the US Geological Survey (USGS)***. Data latency may be less than 24 h for data acquired at the Landsat Ground Station, to 1-2 weeks for data acquired at other USGS stations. Other distributors exist, including ESA/ESRIN.

4.3.3 The EOS programme

The original aim of the ***Earth Observing System (EOS)*** was based on four series of three satellites each to cover 15 years of continuous observations: a multi-purpose mission in a.m. orbit (AM), one in p.m. orbit (PM), a chemistry mission (CHEM) and an altimetry mission (ALT). With the advent of NPOESS, that took over the long-term continuity of operational missions, EOS has been re-structured as one-shot missions, three large (Terra, Aqua and Aura), others single-payload. This Section includes the three main missions and a selection of others (SeaStar, QuickSCAT, Coriolis and ICESat), considered most relevant for the GOS. The chronology of these missions is reported in ***Table 4.3.3***. Ocean altimetry missions are reported under Section 4.3.5. ***Figures 4.3.4, 4.3.5 and 4.3.6*** provide sketch views of EOS-Terra, EOS-Aqua and EOS Aura respectively.

Table 4.3.3 – Chronology of the EOS programme (in bold the satellites active in Sept 2005)

Satellite	Launch	End of service	Height	LST/incl.	Status (Sept 2005)	Instruments
SeaStar	1 Aug 1997	expected \geq 2006	705 km	12:00	Operational	SeaWiFS
QuickSCAT	19 Jun 1999	expected \geq 2006	803 km	06:00	Operational	SeaWinds
EOS-Terra	18 Dec 1999	expected \geq 2006	705 km	10:30	Operational	MODIS, CERES, ASTER, MISR, MOPITT
EOS-Aqua	4 May 2002	expected \geq 2008	705 km	13:30	Operational	MODIS, CERES, AIRS, AMSU-A, HSB, AMSR-E,
Coriolis	6 Jan 2003	expected \geq 2008	830 km	?????	Operational	WindSat
ICESat	12 Jan 2003	expected \geq 2005	600 km	94°	???????	GLAS
EOS-Aura	15 Jul 2004	expected \geq 2010	705 km	13:45	Operational	HIRDLS, EOS-MLS, OMI, TES

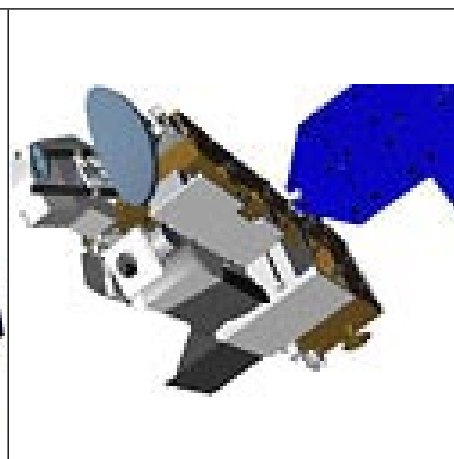
**Fig. 5.3.4 – Sketch view of Terra.****Fig. 5.3.5 – Sketch view of Aqua.****Fig. 5.3.6 – Sketch view of Aura.**

SeaStar was launched to provide continuity of ocean colour observation after the end of the Nimbus-7 CZCS (1994). It was actually a NASA data-purchase undertaking, since the satellite, also known as **OrbView-2**, was owned by the *OrbImage* Company. It has a single payload:

- **SeaWiFS (Sea-viewing Wide Field-of-view Sensor)**, 8-channel radiometer, range 400-890 nm, narrow bandwidths to observe ocean colour and aerosol; resolution 1.1 km s.s.p., swath 2800 km.

QuickSCAT (Quick Scatterometer Mission) was launched to provide continuity to the *NASA Scatterometer (NSCAT)* of ADEOS-I, failed in 1997. The instrument, considerably different from NSCAT, was also re-flown on ADEOS-II (2002-2003). Single payload:

- **SeaWinds**, radar scatterometer in Ku-band (13.4 GHz) with two beams and conical scanning so as to view each spot four times under different angles. Resolution 50 km, swath 1800 km.

Coriolis was launched as a proof-of concept mission, to demonstrate that wind direction, in addition to wind speed, can be observed by passive radiometry by exploiting multi-polarisation instead of active system (radar). In fact, it is considered as a risk-reduction mission for the NPOESS *CMIS*. Payload:

- **WindSat**, 22-channel MW radiometer with frequencies 6.8, 10.7, 18.7, 23.8 and 37 GHz and full polarimetric observation (i.e. 6 polarisations) at frequencies 10.7, 18.7 and 37 GHz and two polarisations at frequencies 6.8 and 23.8 GHz. Resolution 25 km, swath 1000 km. Of course, WindSat can also observe sea-surface temperature, precipitation, ice, snow and soil moisture index.

ICESat (Ice, Cloud and land Elevation Satellite) was launched to measure polar ice elevation with unprecedented accuracy as allowed by using a laser altimeter. Of course, it can also measure cloud top height and land elevation. Payload:

- ***GLAS (Geoscience Laser Altimeter System)***, a dual-wavelength laser, 532 and 1064 nm; nadir-only view with sampling at 170 m intervals for along-track near-continuous profiling. Cross-track, in 183 days (the orbital repeat cycle) global coverage is achieved with 15-km gaps at the equator and 2.5 km gaps at 80° latitude.

EOS-Terra is a multi-purpose satellite to serve most environmental areas. Payloads:

- **MODIS (Moderate-resolution Imaging Spectro-radiometer)**, 36-channel radiometer covering the range 0.4-14.4 μm , split in several groups with different resolution (250, 500 and 1000 m), bandwidths and radiometric accuracy, depending on the addressed application (ocean colour, vegetation, clouds, aerosol, atmosphere). Swath 2330 km.
- **CERES (Clouds and the Earth's Radiant Energy System)**, actually two sub-units to scan cross-track and conically for bi-directional reflectance. 3 broad-band channels (0.3-100 μm , 0.3-5.0 μm , 8-12 μm). Resolution 20 km s.s.p., swath 3000 km.
- **ASTER (Advanced Spaceborne Thermal Emission and Reflection radiometer)**, joint USA-Japan instrument. 14-channel radiometer covering the range 0.5-11.7 μm , with 3 channels in VNIR (resolution 15 m), 6 in SWIR (resolution 30 m) and 5 in TIR (resolution 90 m). Swath 60 km.
- **MISR (Multi-angle Imaging Spectro-Radiometer)**, using 9 cameras to view under 9 different along-track angles (nadir, $\pm 26.1^\circ$, $\pm 45.6^\circ$, $\pm 60.0^\circ$ and $\pm 70.5^\circ$), each view in 4 channels (0.446, 0.558, 0.672 and 0.866 μm), to measure the BRDF (Bidirectional Reflectance Distribution Function). Resolution selectable among 275, 550 and 1.1 km s.s.p., swath 360 km.
- **MOPITT (Measurement Of Pollution In The Troposphere)**, provided by Canada. Gas correlation spectrometer in bands around 2.3, 2.4 and 4.7 μm to measure CO profile and CH₄ total-column. Resolution 22 km s.s.p., swath 616 km.

EOS-Aqua primarily serves operational meteorology by advanced instrumentation. Payload:

- **MODIS**, same as on EOS-Terra.
- **CERES**, same as on EOS-Terra.
- **AIRS (Atmospheric Infra-Red Sounder)**, 2378-channel grating spectrometer in the range 3.74-15.4 μm with resolving power ($\lambda/\Delta\lambda$) 1200 (0.55 cm^{-1} at 15 μm), for temperature, humidity and ozone profiling; supporting 4 channels in the range 0.4-1.0 μm . Resolution 13.5 km s.s.p., swath 1650 km.
- **AMSU-A**, same as on NOAA-15/19 and Metop.
- **HSB (Humidity Sounder for Brazil)**, provided by Brazil: 4-channel MW radiometer, 3 in the H₂O 183 GHz band, one at 150 GHz, resolution 13.5 km s.s.p., swath 1650 km.
- **AMSR-E (Advanced Microwave Scanning Radiometer - EOS)**, provided by Japan, modified from AMSR on ADEOS-II: 12-channel MW radiometer, 6 frequencies (6.9, 10.7, 18.7, 23.8, 36.5 and 89 GHz) all with two polarisations, for sea-surface temperature, sea-surface wind speed, precipitation, ice, snow, soil moisture index. Resolution ranging from 5 km (at 89 GHz) to 60 km (at 6.9 GHz), conical scanning, swath 1400 km.

EOS-Aura is dedicated to atmospheric chemistry. Payload:

- **HIRDLS (High-Resolution Dynamics Limb Sounder)**, joint USA-UK instrument. 21-channel radiometer covering the range 6-18 μm . Species: CFC-11, CFC-12, CH₄, ClONO₂, H₂O, HNO₃, N₂O, N₂O₅, NO₂, O₃, temperature and aerosol. Limb sounding also including scanning at 6 different azimuth angles for a swath of 2000-3000 km; vertical resolution 1 km in the range 10-100 km.
- **EOS-MLS (Microwave Limb Sounder)**, improved from MLS on UARS. Five bands at frequencies 118 GHz (9 channels), 190 GHz (6 channels), 240 GHz (7 channels), 640 GHz (9 channels) and 2500 GHz (5 channels) Species: BrO, ClO, CO, H₂O, HCl, HCN, HNO₃, HO₂, HOCl, N₂O, O₃, OH, SO₂, temperature and pressure. Vertical resolution 1.5 km in the range 5-120 km.
- **OMI (Ozone Monitoring Instrument)**, provided by The Netherlands and Finland. A 780-channel grating imaging spectrometer covering the spectral range 270-500 nm with spectral resolution 0.4-0.6 nm. Species: BrO, NO₂, O₃, OClO, SO₂ and aerosol. Cross-nadir electronic scanning, resolution 13 km, swath 2600 km.

- **TES (Tropospheric Emission Spectrometer)**, imaging interferometer for both limb and cross-nadir scanning, covering the spectral range 3.2-15.4 μm with a spectral resolution of 0.06 cm^{-1} (cross-nadir) or 0.015 cm^{-1} (in limb mode). Species: CFC-11, CFC12, CH₄, CO, CO₂, H₂O, HCl, HDO, HNO₃, N₂, N₂O, NH₃, NO, NO₂, O₃, OCS, SO₂ and aerosol. Limb mode: vertical resolution 2.3 km in the range 10-34 km; cross-nadir: horizontal resolution 0.5 x 5 km² s.s.p. over a 5.3 x 8.5 km² area that can be pointed anywhere within a swath of 885 km.

Instrument sheets are provided in Annex A3.2 for all instruments described in this Section 4.3.3.

All data from NASA missions are available from **EOSDIS (Earth Observing System - Data and Information System)** with variable delay from observation taking. For the purpose of the Global Observing System (GOS), the following real-time or near-real time access modes are noted:

- SeaWiFS: may be received in real-time by a HRPT station upon authorisation granted by ORBIMAGE or NASA;
- QuickSCAT data are distributed by NOAA within 3 hours from observation;
- Coriolis/WindSat data are distributed by
- ICESat data are distributed by the US National Snow and Ice Data Center (NSIDC);
- EOS-Terra provides real-time access to MODIS data in X-band by authorised stations;
- EOS-Aqua provides real-time access to all sensor data in X-band by authorised stations;
- EOS-Aura could in principle be received in real-time in X-band.

4.3.4 The Earth System Science Pathfinder programme

The ESSP programme is based on single-shot satellites selected at ~ 2-year intervals according to the principle “small, fast, cheap”. Missions are selected for process study purposes. **Table 4.3.4** provides essential information on the missions so far selected (in order of expected launch date):

- **GRACE (Gravity Recovery and Climate Experiment)** (USA-Germany)
- **CALIPSO (Cloud-Aerosol Lidar and Infrared Pathfinder Satellite Observations)** (USA-France)
- **CloudSat**
- **OCO (Orbiting Carbon Observatory)**
- **Aquarius** (USA-Argentina)
- **HYDROS (Hydrosphere State Mission).**

Table 4.3.4 – List of selected ESSP missions as of Sept 2005

Satellite	Launch	Life	Orbit	Main instruments	Mission
GRACE (2 satellites)	17 Mar 2002	5 y	2 sats dephased 100-500 km, height 300-500 km, 89°	SuperSTAR Accelerometers, K-band satellite-to-satellite ranging	Gravity field anomalies and accurate geoid
CALIPSO	Nov 2005	3 y	Sunsynchronous, 587 km, LST 13:30	Two-wavelength (532 and 1024 nm) polarisation-sensitive lidar, 3-channel imager (8.7, 10.5 and 12 μm), wide-field camera	Cloud microphysics and radiative properties, cirrus clouds, aerosol
CloudSat	Nov 2005	2 y	Sunsynchronous, 705 km, LST 13:30	94 GHz Cloud Profiling Radar (CPR)	Cloud profile and radiative properties
OCO	2007	2 y	Sunsynchronous, 705 km, LST 13:18	3 grating spectrometers covering bands 0.76, 1.61 and 2.06 μm	CO ₂ profile
Aquarius	2009	3 y	Sunsynchronous, 657 km, LST 06/18	L-band radiometer/scatterometer with polarimetric capability	Global sea-surface salinity
HYDROS	2011	2 y	Sunsynchronous, 670 km, LST 06/18	L-band radiometer/radar with polarimetric capability	Soil moisture and freeze/thaw conditions

Data from ESSP missions may be released for use within the GOS to improve modelling and parameterisation in NWP.

4.3.5 Selection of other missions relevant to GOS

In this Section a selection of other missions relevant to GOS are reported, often implemented through international cooperation, mainly bilateral. The following areas are considered:

- observation of precipitation
- sounding missions exploiting GPS radio-occultation

whereas ocean altimetry missions in cooperation with CNES are reported under Section 4.5.

Table 4.3.5 reports the main features of the missions that will be shortly described.

Table 4.3.5 – Chronology of international missions (in bold the satellites active in Sept 2005)

Satellite	Launch	End of service	Height	LST/incl.	Status (Sept 2005)	Instruments
TRMM	27 Nov 1997	expected ≥ 2006	402 km	35°	Operational	PR, TMI, LIS, VIRS, CERES
GPM “core”	2010	expected ≥ 2015	407 km	65°	Planned	DPR, GMI
Microlab-1	1 Apr 1995 2001	785 km	70°	Inactive	OTD, GPS/MET
SAC-C	21 Nov 2000 2002	705 km	10:15	Inactive	GOLPE + others
CHAMP	15 Jul 2000	expected ≥ 2006	450 km	87°	Operational	BlackJack + others
COSMIC satellites) (6	Dec 2005	expected ≥ 2010	800 km	71°	Close to launch	IGOS

4.3.5.1 TRMM and the GPM

The *Tropical Rainfall Measuring Mission (TRMM)* is implemented in cooperation of USA and Japan as a main contribution to the Global Energy and Water-cycle Experiment (GEWEX). It carries the following instruments:

- **PR (Precipitation Radar)**, provided by Japan. An imaging radar operating at 13.8 GHz to measure precipitation profiles. Resolution 4.3 km s.s.p. (horizontal), 250 m (vertical); electronic scanning, swath 215 km.
- **TMI (TRMM Microwave Imager)**, derived from the DMSP SSM/I. Five frequencies (10.65, 19.35, 21.3, 37.0 and 85.5 GHz), all with two polarisations except 21.3 GHz. Conical scanning, resolution ranging from 6 km (at 85.5 GHz) to 50 km (at 10.65 GHz), swath 760 km.
- **LIS (Lightning Imaging Sensor)**, CCD camera with special filter at 777.4 nm (O-1 line) to detect lightning intensity and flash rate during the ~ 90 s when a spot is imaged onto the CCD. Resolution 4 km s.s.p. (horizontal), 2 ms (temporal), swath 600 km.
- **VIRS (Visible and Infra-Red Scanner)**, derived from AVHRR. 5-channel radiometer (0.63, 1.6, 3.75, 10.8 and 12 µm), resolution 2 km s.s.p., swath 720 km.
- **CERES (Clouds and the Earth’s Radiant Energy System)**, simplified from the one on EOS Terra and Aqua in so far it only includes the cross-track scanning unit. 3 broad-band channels (0.3-50 µm, 0.3-5.0 µm, 8-12 µm), resolution 10 km s.s.p., swath 1800 km.

The **GPM (Global Precipitation Measurement mission)** is being prepared within an international context. Its objective is to provide global coverage of precipitation data at 3-hour intervals, the basic instrument being a MW conical scanning radiometer of the TRMM-type (*TMI*) or better. Due to the limited swath of conical scanners, the 3-h frequency requires 8 satellites in regularly de-phased near-polar orbits. Of these, three will consist of the NPOESS satellites, specifically by the *CMIS* radiometer, whose performance exceeds by far the minimum requirement. Other contributions are being considered by other space agency (one by NASA itself). In addition, the constellation include a “**GPM core**”

satellite that provides high-quality information to “calibrate” the other satellites of the constellation, being equipped with:

- **DPR (Dual-frequency Precipitation Radar)**, to be provided by Japan. Two frequencies, 13.6 and 35.55 GHz for heavy and light precipitation respectively. Resolution 4.3 km s.s.p. (horizontal), 250 m (vertical); electronic scanning, swath 215 km.
- **GMI (GPM Microwave Imager)**, with improved resolution in respect of *TMI*. Five frequencies (10.65, 18.7, 23.8, 36.5 and 89 GHz), all with two polarisations except 23.8 GHz. Option for channels at 166 GHz (two polarisations) and 183 GHz (three channels) are considered. Conical scanning, resolution ranging from 3.0 km (at 89 GHz) to 25 km (at 10.65 GHz), swath 850 km.

Instrument sheets are provided in Annex A3.2 for all instruments described in this Section 4.3.5.1.

For the purpose of data access in support of GOS, the current practise is to make available precipitation products on ftp sites. The latency time is few hours.

4.3.5.2 Radio-occultation sounding missions

Microlab-1, thereafter re-named *OrbView-1*, carried out the demonstration of the GPS radio-occultation technique to observe high-vertical-resolution temperature-humidity-pressure profiling. Payload:

- **GPS/MET (Global Positioning System / Meteorology)**, collecting about 200 occultation events/day by tracking GPS satellites during setting (antenna pointing aft-, i.e. anti-velocity).
- **OTD (Optical Transient Detector)**, precursor of the TRMM *LIS* for mapping lightning events. CCD camera with special filter at 777.4 nm. Resolution 10 km s.s.p. (horizontal), 2 ms (temporal), swath 1300 km.

On the Argentinean *SAC-C (Satélite de Aplicaciones Científicas - C)*, carrying several instruments, NASA provided:

- **GOLPE (GPS Occultation and Passive reflection Experiment)**, improved in respect of *GPS/MET*, collecting about 500 occultation events/day by tracking GPS satellites during both setting and rising (two antennas pointing aft- and fore-).

On *CHAMP (Challenging Mini-Satellite Payload)*, a Germany-USA cooperative mission carrying several instruments, NASA provided:

- **BlackJack**, same instrument as *GOLPE* except that there is a single occultation antenna that points aft- (thus for setting) collecting about 230 occultation events/day.

To greatly increase the number of occultation events per day, *COSMIC (Constellation Observing System for Meteorology, Ionosphere & Climate)* is about to be launched. The constellation includes 6 satellites launched at once, thereafter displaced in more orbital planes in a one-year time span. *COSMIC* is a cooperative USA-Taiwan mission, also called *FormoSat-3*. The payload is:

- **IGOS (Integrated GPS Occultation Receiver)**, based on *BlackJack* with antennas pointing fore- and aft- for both setting and rising occultation events (about 500 events/day per satellite). With 6 satellites, 3000 occultations/day will be collected, providing a daily global coverage with an average sampling distance of 400 km.

Instrument sheet relative to this Section 4.3.5.2 is provided in Annex A3.2 only for *BlackJack*, that is the basis for all configurations, generally differing only for the antennas number and accommodation.

For the purpose of data access in support of GOS, the current practise is to make available the products on ftp sites. The latency time is several days.

4.4 The JAXA programmes

JAXA (Japan Aerospace Exploration Agency) and the preceding *NASDA (National Space Development Agency)*, in addition to supporting the Japan Meteorological Agency (JMA) for implementing the GMS and MTSAT programmes (see Section 2.4), have developed remote sensing satellites starting with MOS-1 in 1987. Since then, several missions have been implemented, each one building on the previous one, with evolutionary payloads. **Table 4.4.1** reports the chronology of NASDA/JAXA remote sensing satellites. **Fig. 4.4.1** shows the aspect of ADEOS-2. In addition, Japan has provided instruments and/or launch service for several bilateral missions such as:

- TRMM (*PR* and launch service) (see Section 4.3.5.1)
- *ASTER* on EOS-Terra (see Section 4.3.3)
- *AMSR-E* on EOS-Aqua (see Section 4.3.3);

and plans to provide:

- the *Dual-frequency Precipitation Radar* on the “core” GPM satellite (see Section 4.3.5.1)
- the *Cloud Radar* on Earth-CARE (see Section 4.2.3).

Table 4.4.1 – Chronology of NASDA/JAXA remote sensing satellites

Satellite	Launch	End of service	Height	LST	Status (mid-2005)	Instruments
MOS-1	19 Feb 1987	29 Nov 1995	908 km	10:15	Inactive	MESSR, VTIR, MSR
MOS-1B	7 Feb 1990	25 Apr 1996	908 km	10:33	Inactive	MESSR, VTIR, MSR
JERS	11 Feb 1992	11 Oct 1998	568 km	10:45	Inactive	SAR, OPS
ADEOS-1	17 Aug 1996	30 Jun 1997	797 km	10:30	Inactive	OCTS, AVNIR, NSCAT, TOMS, POLDER, IMG, ILAS, RIS
ADEOS-2	14 Dec 2002	25 Oct 2003	812 km	10:30	Inactive	AMSR, GLI, SeaWinds, ILAS-II, POLDER, DCS
ALOS	Dec 2005	expected \geq 2010	692 km	10:30	Close to be launched	PRISM, AVNIR-2, PALSAR
GOSAT	Aug 2008	expected \geq 2013	666 km	13:00	Planned	TANSO-FTS, TANSO-CAI



Fig. 4.4 - Sketch view of ADEOS-2.

Two flight models of *MOS (Marine Observatory Satellite)*⁵ were launched, *MOS-1* and *MOS-1B*, equipped with:

- **MESSR (Multi-spectral Electronic Self-Scanning Radiometer)**, two parallel 4-channel VIS/NIR push-broom instruments, for vegetation observation (0.51-0.59, 0.61-0.69, 0.73-0.80 and 0.80-1.10 μm), resolution 50 m, swath 185 km for the coupled instruments.
- **VTIR (Visible and Thermal Infrared Radiometer)**, 4-channel radiometer for cloud observation, resolution 0.9 km s.s.p. in channel 0.5-0.7 μm , and 2.7 km s.s.p. in channels 6.0-7.0, 10.5-11.5 and 11.5-12.5 μm ; swath 1500 km.
- **MSR (Microwave Scanning Radiometer)**, two-channel radiometer with frequencies 23.8 and 31.4 GHz for total-column water vapour over the ocean; resolution 23 km at 31 GHz, 32 km at 23 GHz, swath 320 km.

*JERS (Japanese Earth Resources Satellite)*⁶ was equipped with two rather important instruments:

- **SAR (Synthetic Aperture Radar)**, operating in L-band (1.275 GHz) best suited for soil moisture and ocean-surface small-scale features. Resolution 18 m, swath (side looking) 75 km, duty cycle %.
- **OPS (Optical Sensor)**, an 8-channel push-broom radiometer in the range 0.52 to 2.40 μm for vegetation type and land use; resolution 20 m, swath 75 km; one channel with fore-viewing (15.33°) for stereoscopy.

Two flight models of *ADEOS (Advanced Earth Observing Satellite)*⁷ were launched, equipped with many instruments to comply with a multi-purpose mission:

- **OCTS (Ocean Color and Temperature Scanner)** [ADEOS-1], evolution of *VTIR*: a 12-channels radiometer, 8 narrow-bandwidth in the range 0.40-0.89 μm for ocean colour and vegetation, 4 in the range 3.5-12.7 μm ; resolution 700 m s.s.p., swath 1400 km.
- **AVNIR (Advanced Visible and Near-Infrared Radiometer)** [ADEOS-1], evolution of *MESSR*: a 5-channel radiometer for vegetation (0.42-0.50, 0.52-0.60, 0.61-0.69, 0.76-0.89 and the panchromatic 0.52-0.69 μm), resolution 16 m (8 m the panchromatic); electronic scanning covering a swath of 80 km at s.s.p., possible to be pointed cross-track.
- **GLI (Global Imager)** [ADEOS-2], evolution of *OCTS*, a 36-channel spectroradiometer covering the range 0.38-12.0 μm , split in several groups with different resolution (250 and 1000 m), bandwidths and radiometric accuracy, depending on the addressed application (ocean colour, vegetation, clouds, aerosol, atmosphere). Swath 1600 km.
- **NSCAT (NASA Scatterometer)** [ADEOS-1], radar scatterometers for sea-surface wind provided by NASA, frequency 14 GHz, resolution 25 km or (for more accurate products) 50 km, two swaths of 600 km on each side cross-track.
- **SeaWinds** [ADEOS-2], radar scatterometers for sea-surface wind provided by NASA, operating in Ku-band (13.4 GHz) with two beams and conical scanning so as to view each spot four times under different angles. Resolution 50 km, swath 1800 km. Also flown as a single mission on the NASA QuickSCAT, still operational (see Section 4.3.3). See instrument sheet in Annex A3.2.
- **AMSR (Advanced Microwave Scanning Radiometer)** [ADEOS-2], 14-channel MW radiometer, 6 frequencies (6.9, 10.7, 18.7, 23.8, 36.5 and 89 GHz) all with two polarisations, plus two (50.2 and 53.8 GHz) with one polarisation; for sea-surface temperature and wind speed, precipitation, ice, snow, soil moisture. Resolution ranging from 5 km (at 89 GHz) to 60 km (at 6.9 GHz); conical scanning, swath 1600 km. Also flown on EOS-Aqua as *AMSR-E*, still operational (see Section 4.3.3). See instrument sheet in Annex A3.2.
- **POLDER (Polarization and Directionality of the Earth's Reflectances)** [ADEOS-1/2], provided by CNES: a 9-wavelegth radiometer with narrow-bandwidths in the range 443-910 nm and three

⁵ Original name: *Momo*, that means "Peach tree".

⁶ Original name: *Fuyo*, a Japanese flower.

⁷ Original name: *Midori*, that means "Green".

polarisations at three wavelengths for a total of 15 channels; for aerosol, ocean colour and vegetation. Resolution 6.5 km s.s.p., electronic scanning, swath 2200 km, more viewing angles.

- **TOMS (Total Ozone Mapping Spectrometer)** [ADEOS-1], provided by NASA: 6 channels in the range 310-380 nm, 1 nm bandwidth, for total-column ozone. Resolution 50 km, swath 2700 km. It was flown on Nimbus-7 (1978), Meteor-3-6 (1991) and as a dedicated mission, TOMS Earth Probe (1996) (see Section 4.3.1.1).
- **IMG (Interferometric Monitor for Greenhouse gases)** [ADEOS-1], operating in three spectral ranges, 3.3-4.3 μm , 4.3-5.0 μm and 5.0-16.7 μm , with spectral resolution 0.05 cm^{-1} (unapodised). Species: CFC-11, CFC12, CH_4 , CO , CO_2 , H_2O , HCl , HDO , HNO_3 , N_2 , N_2O , NH_3 , NO , NO_2 , O_3 , OCS , SO_2 and aerosol. Resolution 8 km, nadir-only view.
- **ILAS (Improved Limb Atmospheric Spectrometer)** [*ILAS-I* on ADEOS-1, *ILAS-II* on ADEOS-II], *ILAS-I* had two grating spectrometers in the ranges 6.21-11.77 μm (44 channels) and 0.753-0.784 μm (1024 channels). Species: CFC-11, CH_4 , H_2O , HNO_3 , N_2O , NO_2 , O_3 and aerosol. *ILAS-II* had two further bands in the ranges 3.0-5.7 μm (22 channels) and 12.78-12.85 μm (22 contiguous channels of spectral resolution 0.2 cm^{-1}). Further species: CFC-12 and ClONO_2 . Limb sounder operating in sun occultation. Resolution: ~ 300 km (horizontal), 1 km (vertical) in the range 10-60 km.
- **RIS (Retroreflector In Space)** [ADEOS-1], corner cube reflector for atmospheric absorption measurement in the path ground-satellite-ground. Spectral range: 0.4-14 μm . Species: CFC-12, CH_4 , CO , HNO_3 , O_3 and aerosol. Observation obtained when the satellite flies over the laser station.
- **DCS (Data Collection System)** [ADEOS-2], joint NASDA/CNES development following the NOAA/POES DCS/*Argos* (see Section 3.2).

ALOS (Advanced Land Observing Satellite) is addressing land observation by advanced instruments:

- **PRISM (Panchromatic Remote-sensing Instrument for Stereo Mapping)**, a single-channel (0.52-0.77 μm) radiometer with three views, fore-, nadir and aft-, for stereoscopic imagery aiming at accurate Digital Elevation Model (DEM). Resolution 2.5 m, electronic scanning of a swath 35 km wide (70 km for the nadir observation). See instrument sheet in Annex A3.2.
- **AVNIR-2 (Advanced Visible and Near-Infrared Radiometer - 2)**, evolution of the ADEOS-1 AVNIR: a 4-channel radiometer for vegetation (0.42-0.50, 0.52-0.60, 0.61-0.69 and 0.76-0.89); resolution 10 m; electronic scanning covering a swath of 70 km at s.s.p., possible to be pointed cross-track. See instrument sheet in Annex A3.2.
- **PALSAR (Phased-Array L-band Synthetic Aperture Radar)**, evolution of SAR on JERS: an L-band SAR (1.27 GHz) for soil moisture and ocean-surface small-scale features. Several modes are possible by selecting polarisations, side pointing and consequently changing resolution and swath:
 - *high resolution mode* over a swath 40-70 km, with either 7-44 m resolution and single polarisation mode, or 14-89 m resolution and two polarisation modes;
 - *scanSAR mode* over a swath 250-350 km, with 100 m resolution and one polarisation mode;
 - *polarimetry mode* over a swath 30 km with resolution 24-89 m and four polarisation modes.
 The instrument duty cycle is 17.5 %. See instrument sheet in Annex A3.2.

GOSAT (Green-house gas Observing Satellite) is a mission specifically addressing key green-house gases for implementing the Kyoto protocol. Two instruments are foreseen:

- **TANSO-FTS. (Thermal And Near-infrared Sensor for carbon Observations - Fourier Transform Spectrometer)**, a 4-band interferometer (three in the range 0.75-2.1 μm , one in the range 5.5-14.3 μm), with spectral resolution 0.2 cm^{-1} (0.5 cm^{-1} in band 1 centred on 0.76 μm), to track CO_2 , CH_4 and other species. Resolution 10.5 km, swath 790 km. See instrument sheet in Annex A3.2.
- **TANSO-CAI (Thermal And Near-infrared Sensor for carbon Observations - Cloud and Aerosol Imager)**, a pushbroom 4-channel narrow-band imager (380, 674, 870 and 1600 nm) to detect and correct the cloud and aerosol interference from TANSO-FTS. Resolution 0.5 km s.s.p. (1.5 km for channel 1600 nm), swath 1000 km. See instrument sheet in Annex A3.2.

For the purpose of data access in support of GOS, the following is noted. JAXA has organised a full scheme for ALOS data distribution. The instrument output data are collected through a Data Relay Satellite (240 Mbps) or by direct read-out (120 Mbps) to the JAXA Earth Observation Center (EOC) and several ALOS Data Nodes (ADN), ideally one in each continent. The ADN are also responsible for processing, distributing and archiving data in their area.

4.5 The CNES programmes

CNES has provided or provides instruments for several bilateral missions such as:

- *Argos* and *A-DCS* on *POES* (see Section 3.2) and *Metop/EPS* (see Section 3.5)
- the platform (*Proteus*) and the infrared imager for *CALIPSO* (see Section 4.3.4)
- *ScaRaB* on *Meteor-3-7* (see Section 3.6) and on *Resurs-O1-4* (see Section 4.7)
- *DORIS* on *Envisat* (see Section 4.2.2)
- *POLDER* on *ADEOS-1/2* (see Section 4.4)
- *IASI* on *Metop/EPS* (see Section 3.5).

To be fair with history, record should also be kept of:

- the initiating role of CNES for the *Meteosat* programme across years 1970-72;
- the *EOLE* mission in 1971 to study the southern hemisphere circulation at the altitude 10-15 km by constant-level balloons tracked by a data collection and location satellite.

We group here the CNES main Earth Observation programmes under two headings:

- land observation
- ocean and atmosphere missions.

4.5.1 Land observing missions

SPOT (Satellite Pour l'Observation de la Terre) is the main CNES Earth Observation programme, dated 1986 and progressively evolved both as platform and instrumentation (see *Fig. 4.5.1*). *Table 4.5.1* records the chronology of the *SPOT* programme and introduces its successor, *Pléiades*.

Table 4.5.1 – Chronology of CNES land observation missions (in bold the satellites active in Sept 2005)

Satellite	Launch	End of service	Height	LST/incl.	Status (Sept 2005)	Instruments
SPOT-1	22 Feb 1986 2003	822 km	10:30	Inactive	HRV
SPOT-2	22 Jan 1990	expected ≥ 2005	822 km	10:30	Partly operational	HRV, DORIS
SPOT-3	26 Sep 1993	14 Nov 1996	822 km	10:30	Inactive	HRV, POAM-2, DORIS
SPOT-4	24 Mar 1998	expected ≥ 2006	822 km	10:30	Operational	HRVIR, Vegetation, POAM-3, SILEX, PASTEC, DORIS
SPOT-5	4 May 2002	expected ≥ 2008	822 km	10:30	Operational	HRG, HRS, Vegetation, DORIS
Pléiades-1	end-2008	expected ≥ 2013	694 km	10:15	Under development	HR
Pléiades-2	early 2010	expected ≥ 2015	694 km	10:15	Planned	HR

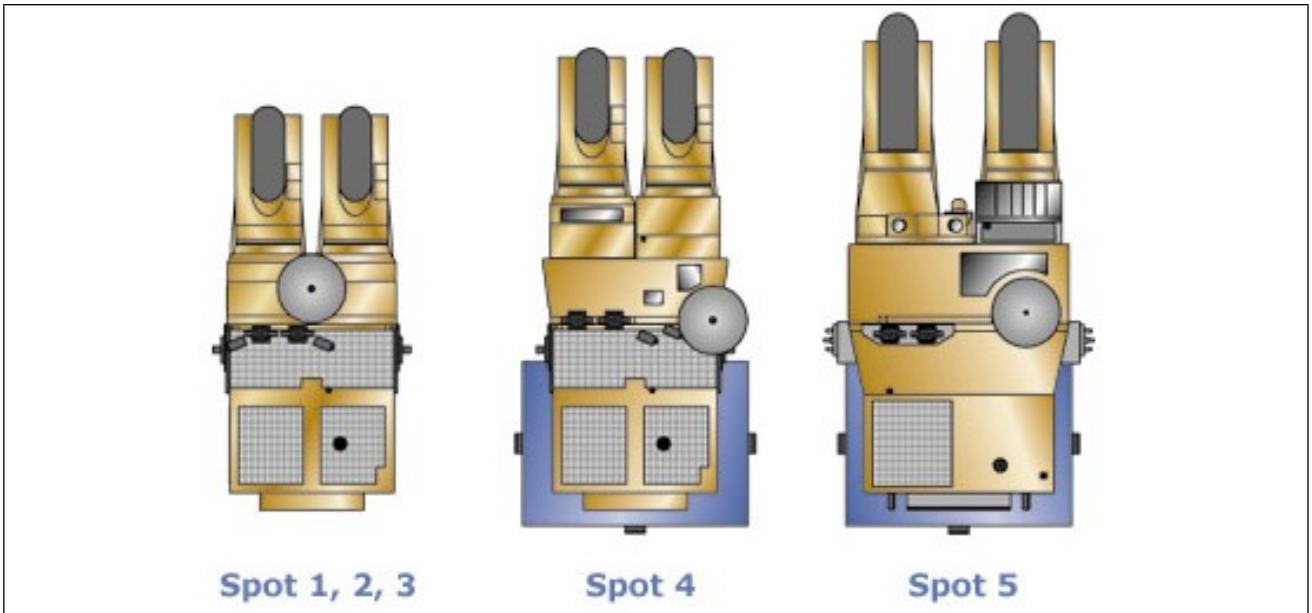

Fig. 4.5.1 – Evolution of the SPOT satellites.

The *SPOT instrumentation* has evolved with time, progressively improving the resolution and the operational flexibility, as described below:

- **HRV (*Haut Résolution dans le Visible*)** [SPOT-1/2/3] is actually composed of two bushbroom scanning parallel instruments to image either two adjacent strips for a composite swath of 117 km (60 km + 60 km with some overlap), or two off-nadir strips up to 900 km apart, each one up to 80 km wide. The off-nadir pointing capability enables more frequent observation of a target area and possibility of stereoscopy in between successive orbits. Two operation modes are available: multispectral (0.50-0.59 μm , 0.61-0.68 μm , 0.79-0.89 μm) with 20 m resolution, or panchromatic (0.51-0.73 μm) with 10 m resolution. See instrument sheet in Annex A3.2.
- **HRVIR (*Haut Résolution dans le Visible et l'Infra-Rouge*)** [SPOT-4] improves over *HRV* in so far as a SWIR channel is added (1.58-1.75 μm) and the panchromatic function is provided by the 0.61-0.68 μm channel. The multispectral and the panchromatic functions may now work at the same time. The two instruments can be pointed independently. See instrument sheet in Annex A3.2.
- **HRG (*Haut Résolution Géométrique*)** [SPOT-5] is a further improvement. The resolution of three basic channels (now 0.49-0.61 μm , 0.61-0.68 μm , 0.78-0.89 μm) is improved to 10 m whereas channel 1.58-1.75 μm remains 20 m. The panchromatic channel (now 0.49-0.69 μm) has now 5 m resolution and is doubled, with a small offset between the two images. On the ground, the two 5-m images are co-processed to obtain a 2.5-km image (*super-mode*). See instrument sheet in Annex A3.2.
- **HRS (*Haut Résolution Stéréoscopique*)** [SPOT-5] is designed to implement stereoscopy in-orbit instead of between successive orbits. The *HRV* panchromatic channel (0.51-0.73 μm) with 10 m resolution is re-introduced, with sampling at 5-m intervals along track. The swath is stretched to 120 km. Fore- and aft- images are taken, $\pm 20^\circ$ off-nadir. See instrument sheet in Annex A3.2.
- **Végétation** [SPOT-4/5] is designed for frequent medium-resolution observation at global scale. It has 4 channels similar to *HRVIR* and *HRG*: 0.43-0.47 μm , 0.61-0.68 μm , 0.78-0.89 μm and 1.58-1.75 μm , but the resolution is 1.15 km s.s.p. and the swath 2200 km, for near-daily global coverage. See instrument sheet in Annex A3.2.
- **POAM (*Polar Ozone and Aerosol Measurement*)** [SPOT-3/4], provided by the U.S. Naval Research Laboratory: a 9-channel limb sounding solar occultation radiometer in the range 350-1060 nm), slightly different in SPOT-3 (*POAM-2*) and SPOT-4 (*POAM-3*). Species: H₂O, NO₂, O₂, O₃ and aerosol. Vertical resolution 0.6 km, range 10-60 km. See instrument sheet in Annex A3.2.
- **SILEX (*Semiconductor Intersatellite Link Experiment*)** [SPOT-4], provided by ESA: a laser-based experimental satellite-to-satellite communication package (with the geostationary ARTEMIS).
- **PASTEC (*Technology Demonstration Passenger*)** [SPOT-4], a package of seven instruments for spacecraft and *in situ* environment monitoring.
- **DORIS (*Détermination d'Orbite et Radiopositionnement Intégrés par Satellite*)** [SPOT-2/3/4/5], for precision orbit determination.

The series to replace SPOT, *Pléiades*, is being developed. It will provide optical images in coordination with the Italian COSMO-SkyMed satellite constellation that will provide X-band SAR images, and the Argentinean SAOCOM satellite constellation equipped with L-band SAR. The *Pléiades* satellites will fly in formation to provide, thanks to the off-nadir pointing capability, the potential of observing any target area of the Earth's surface within one day. Each satellite will carry one main instrument:

- **HR (*Haut Résolution*)**, with 4 VIS/NIR channels (0.45-0.53 μm , 0.52-0.58 μm , 0.62-0.70 μm , 0.78-0.89 μm) at 2.8 m resolution s.s.p. and a panchromatic channels (0.48-0.90 μm) at 0.7 m resolution s.s.p., over a 20 km swath (when viewed at nadir). By combining all cross-track and along-track pointing capabilities it will be possible to implement composite images of 120 km x 120 km and stereoscopic images of 20 km x 300 km. See instrument sheet in Annex A3.2.

For the purpose of data access in support of GOS, the following is noted. SPOT data can be received in real time by X-band stations licensed by CNES and SPOT-Image. The data rate is 150 Mbps (for SPOT-5). Otherwise, a very efficient distribution system exists, managed by SPOT-Image.

It is supported by main CNES receiving stations in Kiruna and Toulouse and a network of over 20 local stations worldwide spread. To be noted that, due to the narrow instrument swaths and the pointing capability, observations of specific areas need to be booked in advance within the operations plan.

4.5.2 Ocean and atmosphere missions

Table 4.5.2 lists several CNES missions for atmosphere and ocean, generally implemented through bilateral or multi-lateral collaboration (all in the list, except PARASOL). **Fig. 4.5.2** shows the technological trend from TOPEX-Poseidon to Jason: equal performance with a satellite mass five times smaller. PARASOL, in **Fig. 4.5.3**, also is a mini-satellite.

Table 4.5.2 – Chronology of CNES ocean and atmosphere missions (in bold the satellites active in Sept 2005)

Satellite	Launch	End of service	Height	LST/incl.	Status (Sept 2005)	Instruments
TOPEX-Poseidon	10 Aug 1992	expected \geq 2006	1336 km	66°	Operational	NRA, SSALT, TMR, DORIS
JASON	7 Dec 2001	expected \geq 2006	1336 km	66°	Operational	Poseidon-2, JMR, DORIS
OSTM (JASON-2)	2008	expected \geq 2013	1334 km	66°	Planned	Poseidon-3, AMR, DORIS
PARASOL	18 Dec 2004	expected \geq 2006	705 km	13:30	Operational	POLDER+
Megha-Tropique	end-2009	expected \geq 2014	867 km	20°	Planned	MADRAS, SAPHIR, ScaRaB



Fig. 4.5.2 - Size reduction from TOPEX-Poseidon to Jason.

Fig. 4.5.3 - Sketch view of PARASOL.

4.5.2.1 Ocean altimetry missions

TOPEX-Poseidon is a joint USA-France programme originated from merging the NASA *TOPEX (Topography Experiment)* and the CNES *Poseidon*. It carries the following instruments, complemented by a series of navigation facilities for precision orbitography:

- **NRA (NASA Radar Altimeter)** makes use of Ku-band (13.6 GHz) supported by S-band (5.3 GHz) for ionospheric correction. Resolution 25 km (Ku-band), 60 km (S-band), nadir-only view.
- **SSALT (Single-frequency Solid-state Altimeter)**, provided by CNES, makes use of Ku-band (13.65 GHz). It shares the same antenna of NRA, thus the resolution is 25 km. The antenna serves NRA 88 % of the time. SSALT and NRA have approximately the same accuracy (~ 2.5 cm), but the technology of SSALT enables large saving of mass and electrical power.

- **TMR (TOPEX Microwave Radiometer)**, provided by NASA, supports the altimeters by providing water vapour information for correction. 3 frequencies, 18, 21 and 37 GHz. Nadir-only view, resolution 35 km.
- **DORIS (Doppler Orbitography and Radiopositioning Integrated by Satellite)** and other navigation systems, essential for altimetry.

JASON (Joint Altimetry Satellite Oceanography Network) also is a NASA/CNES joint undertaking. The payload includes:

- **Poseidon-2**, provided by CNES, improves from *SSALT* by adding *NRA* capabilities: two frequencies, 13.5785 and 5.3 GHz, resolution 30 km (Ku-band), nadir-only view. With respect to *NAR*, performance is better (2 cm accuracy) and mass/power are reduced to one third.
- **JMR (JASON Microwave Radiometer)**, provided by NASA, is similar to *TMR*: channels at 18.7, 23.8 and 34 GHz, resolution 25 km at 23.8 GHz, nadir-only view.
- **DORIS** and other navigation systems for accurate orbitography.

OSTM (Ocean Surface Topography Mission), formerly known as *JASON-2*, is a joint NASA, CNES, NOAA and EUMETSAT programme. Payload:

- **Poseidon-3**, currently baselined as similar to *Poseidon-2*.
- **AMR (Advanced Microwave Radiometer)**, currently baselined as similar to *JMR*.
- **DORIS** and other navigation systems for accurate orbitography.

Instrument sheets relative to this Section 4.5.2.1 are provided in Annex A3.2 only for the JASON instruments *Poseidon-2* and *JMR*, representing the state-of-the-art.

For the purpose of data access in support of GOS, the current practise is to make available ocean topography products on ftp sites. The latency time is few hours for early products (wave height), several weeks for precision products (topography).

4.5.2.2 Atmospheric missions

PARASOL (Polarisation et Anisotropie des Réflectances au sommet de l'Atmosphère, couplées avec un Satellite d'Observation emportant un Lidar) is a mini-satellite co-flying in the so-called 'A-train', a satellite formation comprising EOS-Aqua and EOS-Aura (see Section 4.3.3), and CALIPSO, CloudSat and OCO (see section 4.3.4). It carries a single instrument, improved after *POLDER* on ADEOS-1/2:

- **POLDER (Polarization and Directionality of the Earth's Reflectances)**, a 9-wavelength radiometer with narrow-bandwidths in the range 443-1020 nm and three polarisations at three wavelengths for a total of 15 channels; for aerosol, ocean colour and vegetation. Resolution 6 km s.s.p., electronic scanning, swath 2200 km, more viewing angles. See instrument sheet in Annex A3.2.

Data from PARASOL can be collected directly from CNES (<http://polder.cnes.fr>) for level 1 data and from Icare (<http://www-icare.univ-lille1.fr>) for level 2 and 3.

CALIPSO (Cloud-Aerosol Lidar and Infrared Pathfinder Satellite Observations) has been reported under the NASA mission (see Section 4.3.4) since it is part of the ESSP programme. CNES has provided the platform (*Proteus*) and the infrared imager.

Megha-Tropiques⁸ is a CNES/ISRO cooperative programme, contribution to the Global Precipitation Measurement mission (GPM, see section 4.3.5.1). It will provide frequent coverage of the tropical regions (each 1.5 hours, whereas the other 8 satellites of the GPM constellation, in sunsynchronous orbit, will provide global coverage at 3-hour intervals). ISRO will provide the platform and the launch service. The instruments will be:

- **MADRAS (Microwave Analysis & Detection of Rain & Atmospheric Structures)**, to be developed by ISRO with CNES contribution: a 5-frequencies (18.7, 23.8, 36.5, 89 and 157 GHz), 9-channel

⁸ "Megha" is the Sanskrit word for "Cloud".

(double polarisation in all channels but 23.8 GHz) conical scanning microwave radiometer. Main objective: precipitation observation. Swath 1740 km. See instrument sheet in Annex A3.2.

- **SAPHIR** (*Sondeur Atmospherique du Profil d'Humidite Intertropicale par Radiometrie*), a 6-channel MW radiometer in the 183.33 GHz band, for water vapour profiling. Cross-nadir scanning, 10 km s.s.p. resolution, 1700 km swath. See instrument sheet in Annex A3.2.
- **ScaRaB** (*Scanner for Radiation Budget*), a 4-channel radiometer, two broad-band (0.2-4.0 μm and 0.2-50 μm), two narrow-band (0.55-0.65 μm and 10.5-12.5 μm), for Earth Radiation Budget at TOA. Resolution 40 km s.s.p., swath 3.200 km. See instrument sheet in Annex A3.2.

4.6 The ISRO programmes

ISRO is running the *IRS (Indian Remote-sensing Satellite)* programme since 1988. There are two series, IRS-1 and the follow-on IRS-P. *Table 4.6.1* records the chronology of the IRS programme. *Fig. 4.6.1, Fig. 4.6.2* and *Fig. 4.6.3* show the aspects of three satellites of the IRS-P series.

Table 4.6.1 - Chronology of the IRS programme (in bold the satellites active in Sept 2005)

Satellite	Launch	End of service	Height	LST	Status (Sept 2005)	Instruments
IRS-1A	17 Mar 1988	??????	904 km	10:30	Inactive	LISS-1, LISS-2-A/B
IRS-1B	29 Aug 1991	??????	904 km	10:30	??????	LISS-1, LISS-2-A/B
IRS-1C	28 Dec 1995	??????	817 km	10:30	??????	PAN, LISS-3, WIFS
IRS-1D	29 Sep 1997	??????	784 km	10:30	??????	PAN, LISS-3, WIFS
IRS-1E = IRS-P1	20 Sep 1993	Launch failed	-	-	Inactive	LISS-1, ME OSS
IRS-P2	15 Oct 1994	??????	817 km	10:30	??????	LISS-2-M
IRS-P3	21 Mar 1996	??????	817 km	10:30	??????	WiFS, MOS, X-AE
IRS-P4 (OceanSat-1)	26 May 1999	expected ≥ 2005	720 km	12:00	Operational	OCM, MSMR
IRS-P5 (CartoSat-1)	5 May 2005	expected ≥ 2010	618 km	10:30	Operational	PAN-A, PAN-F
IRS-P6 (ResourceSat-1)	17 Oct 2003	expected ≥ 2009	817 km	10:30	Operational	LISS-3, LISS-4, AWiFS
OceanSat-2	2006	expected ≥ 2011	720 km	12:00	Planned	OCM, MSMR
CartoSat-2	2007	expected ≥ 2012	618 km	10:30	Planned	PAN-A, PAN-F
ResourceSat-2	2008	expected ≥ 2013	817 km	10:30	Planned	LISS-3, LISS-4, AWiFS



Fig. 4.6.1 - IRS-P4 (OceanSat)



Fig. 4.6.2 - IRS-P5 (CartoSat)

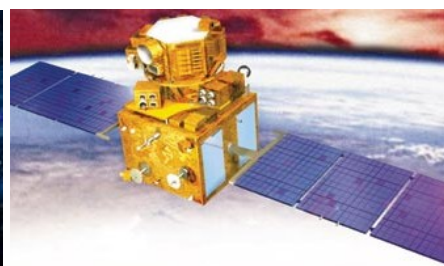

Fig. 4.6.3 - IRS-P6 (ResourceSat)

Instruments on IRS are shortly described in the following.

- **LISS (Limb Imaging Self-Scanning Sensor)**, pushbroom radiometer for vegetation observation, has been flown in several versions. In **LISS-1** [IRS-1A, 1B, 1E/P1] and **LISS-2-A/B** [IRS-1A, 1B] there were 4 channels (0.46-0.52 μm , 0.52-0.59 μm , 0.62-0.68 μm and 0.77-0.86 μm). The resolution of LISS-1 was 72 m with a swath of 140 km, whereas LISS-2-A/B had 36 m and the same swath achieved by two parallel instruments (A and B) each with 36 km swath. **LISS-2M** [IRS-P2] combines the two instruments of LISS-2-A/B into a single one. In **LISS-3** [IRS-1C, 1D and P6] the “blue” channel 0.46-0.52 μm is replaced by a SWIR channels at 1.55-1.75 μm , with resolution 23 m (VNIR channels) and 70 m (SWIR channel), swath still 140 km. In **LISS-4** [IRS-P6] only the three VNIR channels 0.52-0.59 μm , 0.62-0.68 μm and 0.77-0.86 μm are retained, and the resolution is

brought down to 5.8 m, with swath 24 km (multi-spectral) or 70 km (panchromatic). See instrument sheets of LISS-3 and 4 in Annex A3.2.

- **PAN (Panchromatic Camera)** [IRS-1C, ID], single-channel 0.50-0.75 μm , resolution 6 m with swath 70 km when pointing nadir, ≤ 10 m / 90 km when pointing side within a field of regard of 400 km. In IRS-P5 there are two instruments, **PAN-A** and **PAN-F**, view aft- and fore- respectively, for in-orbit stereoscopy. Pushbroom scanning with resolution 2.5 m, swath 30 km. See instrument sheet of PAN-A / PAN-F in Annex A3.2.
- **WiFS (Wide Field Sensor)**, designed for vegetation indexes, was composed of two adjacent pushbroom cameras to cover a composite swath of 770 km with a resolution of 190 m. In IRS-1C and ID there were two channels, 0.62-0.68 μm and 0.77-0.86 μm . In IRS-P3, a 1.55-1.75 μm channel was added.
- **AWIFS (Advanced Wide Field Sensor)** [IRS-P6], is a further improvement. There are now four channels (0.52-0.59 μm , 0.62-0.68 μm , 0.77-0.86 μm and 1.55-1.75, i.e. the same as LISS-3. Pushbroom scanning with resolution 56 m and swath 740 km. See instrument sheet in Annex A3.2.
- **MEOS (Monocular Electro-Optical Stereo Scanner)** [IRS-1E/P1] was a single-channel camera (0.57-0.70 μm) to take three simultaneous images, nadir, fore- and aft- for in-orbit stereoscopy. Pushbroom scanning resolution 150 m, swath 510 km. Not used because of launch failure.
- **MOS (Multispectral Opto-electronic Scanner)** [IRS-P3], provided by Germany, was an instrument complex for ocean colour, vegetation, aerosol and clouds. It included three subsystems: **MOS-A** with 4 channels in the oxygen band around 760 nm, **MOS-B** with 13 channels in the 408-1010 nm range, **MOS-C** with a channel at 1.6 μm . Resolution: **MOS-A** 1.5 km, **MOS-B** and **MOS-C** 0.5 km; swath 200 km.
- **OCM (Ocean Color Monitor)** [IRS-P4], an 8-channel radiometer with narrow bandwidths in the range 402-885 nm for ocean colour and aerosol. Pushbroom scanning, resolution 300 m, swath 1420 km. See instrument sheet in Annex A3.2.
- **MSMR (Multi-frequency Scanning Microwave Radiometer)** [IRS-P4], a 4-frequency, 8-channel MW radiometer (6.6, 10.65, 18 and 21 GHz, all with two polarisations) for surface temperature and wind and total-column water vapour over the sea. Conical scanning, resolution ranging from 27 km (at 21 GHz) to 85 km (at 6.6 GHz); swath 1360 km. See instrument sheet in Annex A3.2.
- **X-AE (X-ray Astronomy Experiment)** [IRS-P3], a package of two X-ray photon counters.

For the purpose of data access in support of GOS, the following is noted. IRS data can be received in real time by appointed X-band stations (data rate 150 Mbps), compatible with SPOT reception (minor modifications necessary). Otherwise, data are acquired and processed by the National Remote Sensing Agency (NRSA) and distributed by Antrix Corporation.

4.7 The RosKosmos programmes

Several R&D satellite series and single missions have been implemented and are planned by the Russian Space Agency, generally as Russia/Ukraine cooperation. For the purpose of GOS, we select here only the series *Resurs* (including the new Monitor-M), and *Okean* (including SICH). *Table 4.7.1* reports the chronology of the two programmes. *Fig. 4.7.1* shows the scheme of Okean-O-1.

Table 4.7.1 – Chronology of Resurs and Okean programmes (in bold satellites active in Sept 2005)

Satellite	Launch	End of service	Height	LST/incl.	Status (Sept 2005)	Instruments
Resurs-O1-1	3 Oct 1985	11 Nov 1986	620 km	????	Inactive	MSU-E, MSU-SK, SAR-Travers
Resurs-O1-2	20 Apr 1988	1 Jun 1999	650 km	????	Inactive	MSU-E, MSU-SK
Resurs-O1-3	4 Nov 1994	???????	675 km	????	Inactive	MSU-E, MSU-SK, others
Resurs-O1-4	10 Jul 1998	Apr 1999	835 km	????	Inactive	MSU-E1, MSU-SK1, MP-900B, ScaRaB, others
Monitor-E	26 Aug 2005	expected ≥ 2008	540 km	????	Operational	PAN, MS
Resurs-DK	2006	expected ≥ 2009	350 km	70.4°	Planned	Geoton
Okean-O1-1	29 Jul 1986	1988	660 km	82.5°	Inactive	RLSBO, RM-08, MWR,
Okean-O1-2	16 Jul 1987	1989	660 km	82.5°	Inactive	MSU-SK, Kondor
Okean-O1-3	5 Jul 1988	1990	660 km	82.5°	Inactive	RLSBO, RM-08, MWR, MSU-SK, Kondor, Trasser
Okean-O1-4	9 Jun 1989	launch failed	-	-	Inactive	RLSBO,
Okean-O1-5	28 Feb 1990	1991	660 km	82.5°	Inactive	RM-08,
Okean-O1-6	4 Jun 1991	1993	660 km	82.5°	Inactive	MWR,
Okean-O1-7	11 Oct 1994	1996	660 km	82.5°	Inactive	MSU-SK,
SICH-1	31 Aug 1995	1996	660 km	82.5°	Inactive	Kondor
Okean-O-1	17 Jul 1999	2000	636 km	82.5°	Inactive	RLSBO, MSU-M, MSU-SK, MSU-V, Delta-2D, R225, R-600, Trasser-O
SICH-1M Dec 2004	launch failed	-	-	Inactive	RLSBO, RM-08, MSU-EU, MTVZA-OK



Fig. 4.7.1 – Scheme of Okean-O-1.

The Resurs series

Resurs satellites are dedicated to land observation. The list of Table 4.7.1 omits the preceding series **Resurs-F1**, **Resurs-F2** and **Resurs-F1M**, about 60 satellites of the Kosmos family launched in the period 1979-1999. The instrumentation of the Resurs-O1 series and beyond is as follows:

- **Geoton** [Resurs-DK], a pushbroom radiometer with resolution 2-3 m when used in multi-spectral mode (0.5-0.6, 0.6-0.7 and 0.7-0.8 μm), 1 m when used in panchromatic mode (0.58-0.80 μm); swath 30 km possible to be addressed within an area of regard of 450 km. See instrument sheet in Annex A3.2.
- **MP-900B** [Resurs-O1-4], a TV camera with resolution 1.7 km, swath 2600 km.
- **MS (Multi-Spectral)** [Monitor-E], a 3-channel (0.54-0.59, 0.63-0.69 and 0.79-0.90 μm) pushbroom radiometer with resolution 20 m and swath 160 km possible to be addressed within an area of regard of 890 km. See instrument sheet in Annex A3.2.
- **MSU-E** [Resurs-O1 1, 2, 3], two side-to-side pushbroom radiometers with 3 channels (0.5-0.6, 0.6-0.7 and 0.8-0.9 μm), resolution 40 m and swath 45 km each, for a coupled swath of 80 km, or two 45-km side swaths possible to be addressed within an area of regard of 600 km. In **MSU-E1** [Resurs-O1-4] due to higher orbit, each radiometer had resolution 50 m and swath 60 km.
- **MSU-SK** [Resurs-O1 1, 2, 3], a conical scanning radiometer with 5 channels, four in VNIR (0.5-0.6, 0.6-0.7, 0.7-0.8, 0.8-1.1 μm), one in TIR (10.4-12.5 μm); resolution 170 m (VNIR) and 600 m (TIR); swath 600 km. In **MSU-SK1** [Resurs-O1-4] a 3.5-4.1 μm channel was added; due to higher orbit, the resolution was 210 m (VNIR) and 700 m (MWIR and TIR), the swath 700 km.
- **PAN (Panchromatic)** [Monitor-E], a single-channel (0.51-0.85 μm) pushbroom radiometer with resolution 8 m and swath 94 km possible to be addressed within an area of regard of 730 km. See instrument sheet in Annex A3.2.
- **SAR-Travers** [Resurs-O1-1], a Synthetic Aperture Radar with two frequencies, S-band (3.28 GHz) and L-band (1.28 GHz).
- **ScaRaB (Scanner for Radiation Budget)** [Resurs-O1-4], a CNES-provided radiometer with two broad-band (0.2-4.0 μm and 0.2-50 μm) and two narrow-band (0.5-0.7 μm and 10.5-12.5 μm) channels; resolution 60 km, swath 3200 km. See instrument sheet in Annex A3.2.

The Okean series

Okean satellites are dedicated to ocean observation. The list of Table 4.7.1 omits the preceding series **Okean-E** and **Okean-OE**, 4 satellites of the Kosmos family launched in the period 1979-1984. The instrumentation of the Okean-O1 series and beyond is as follows:

- **Delta-2D** [Okean.O-1], 4-frequencies / 8-channel MW radiometer (6.9, 13.0, 22.3 and 37.5 GHz all with two polarisations); conical scanning, resolution ranging from 20 km (at 37.5 GHz) to 100 km (at 6.9 GHz), swath 1130 km.
- **Kondor** [all Okean-O1 satellites and SICH-1]: data collection system.
- **MSU-EU** [SICH-1M], a 3-channel (0.50-0.59, 0.61-0.69 and 0.79-0.92 μm) pushbroom radiometer with resolution 30 m and swath 48 km possible to be addressed within an area of regard of 750 km.
- **MSU-M** [Okean-O-1], 4-channel radiometer (0.5-0.6, 0.6-0.7, 0.7-0.8, 0.8-1.1 μm) for multi-purpose imagery; resolution 1.5 km, swath 1900 km
- **MSU-SK** [all Okean satellites and SICH-1]: a conical scanning radiometer with 5 channels, four in VNIR (0.5-0.6, 0.6-0.7, 0.7-0.8, 0.8-1.1 μm), one in TIR (10.4-12.5 μm); resolution 170 m (VNIR) and 600 m (TIR); swath 600 km. Same as for the Resurs series.
- **MSU-V** [Okean-O-1], 8-channel pushbroom radiometer for vegetation mapping; 5 in VNIR in the range 0.45-1.0 μm with resolution 50 m; 2 in SWIR with resolution 100 m (at 1.6 μm) and 300 m (at 2.2 μm), one in TIR (10.6-12.0) with resolution 250 m; swath 200 km.

- **MTVZA-OK** [SICH-1M], a complex of a MW imaging-sounding radiometer (*MTVZA*, see Section 3.6) and a 5-channel VIS/IR radiometer (0.37-0.45, 0.45-0.51, 0.58-0.68, 0.68-0.78 and 3.55-3.93 μm) (OK); conical scanning, resolution 1.1 km for OK, ranging from 19 km (at 183 GHz) to 260 km (at 6.9 km); swath 2000 km.
- **MWR** [Okean-O1 -1 to -7 and SICH-1], 3-channel MW radiometer, frequencies 3.53, 22.2 and 37.5 GHz, nadir-only viewing for sea-surface temperature and wind, and total-column water vapour.
- **R225** and **R-600** [Okean-O-1] were single-frequency / dual polarization MW radiometers, at 13.3 GHz and 5 GHz respectively; resolution 130 and 165 km respectively. Pointing 42° off-nadir.
- **RLSBO**, a real-aperture side-looking radar, exploiting the X-band (9.7 GHz) in all Okean and SICH satellites; Okean-O-1 had two antenna complexes, looking on each side (R = Right L = Left, see Fig. 4.7.2); resolution about 1.8 km, swath 455 km (two swaths, R and L, for Okean-O-1).
- **RM-08** [all Okean and SICH satellites except Okean-O-1], conical scanning radiometer at 36.6 GHz (0.8 cm) for sea-surface wind and sea ice, resolution 20 km, swath 550 km.
- **Trasser** [Okean-O1-3] and **Trasser-O** [Okean-O-1], a polarisation spectroradiometer for ocean colour, vegetation and aerosol; spectral range 430-800 nm, 62 channels of bandwidth 3 nm (at 430 nm) to 12 nm (at 800 nm), all with two polarisations; resolution 45 km; non-scanning instrument viewing 20° off-nadir.

ANNEX 1

Frequencies used from operational meteorological satellites for data transmission to the ground

This Annex collects the information on frequency plans of GOS satellites limited to:

- current and planned operational meteorological satellites in geostationary and sunsynchronous orbits
- frequencies used to download or relay the observed data to the central system station(s) and to local user stations.

This information is already contained in the sections dealing with the individual satellites. The purpose of this section is to provide a friendly framework for keeping the information updated. The level of detail of the information provided is totally insufficient for station design, but may allow the reader to at least capture a broad idea of the complexity of each data acquisition mode.

A1.1 Geostationary satellites

Table A.1.1 reports frequency information for geostationary satellites. It is a simplified presentation, especially as concerns the transmission of raw data to the central facility (only one stream is mentioned, whereas generally there are more). Meteorological data distribution is indicated only when it implies a dedicated user station. Data Collection Platforms are mentioned only when requiring interrogation, and the information refers to the downlink.

Table A.1.1 – Frequency plan of meteorological satellites in geostationary orbit (Sept 2005)

Satellite	Utilisation	Position	Service	Frequency	Bandwidth	Polarisation	Data rate
Meteosat-5	1991-2004	63°E	to PGS	1686.833 MHz	1.3332 MHz	Linear	333 kbps
			HRID	1694.5 MHz	1.5 MHz	Linear	166 kbps
			WEFAX-1	1694.5 MHz	1.5 MHz	Linear	1.6 kHz
			WEFAX-2	1691.0 MHz	1.5 MHz	Linear	1.6 kHz
			MDD	1695.74 MHz	120 kHz (4 channels)	Linear	2.4 kbps
Meteosat-6	1993-2005	10°E	to PGS	1686.833 MHz	1.3332. MHz	Linear	333 kbps
			HRID	1694.5 MHz	1.5 MHz	Linear	166 kbps
			WEFAX-1	1694.5 MHz	1.5 MHz	Linear	1.6 kHz
			WEFAX-2	1691.0 MHz	1.5 MHz	Linear	1.6 kHz
			MDD	1695.74 MHz	120 kHz (4 channels)	Linear	2.4 kbps
Meteosat-7	1997-2005	0°	to PGS	1686.833 MHz	1.3332 MHz	Linear	333 kbps
			HRID	1694.5 MHz	1.5 MHz	Linear	166 kbps
			WEFAX-1	1694.5 MHz	1.5 MHz	Linear	1.6 kHz
			WEFAX-2	1691.0 MHz	1.5 MHz	Linear	1.6 kHz
			MDD	1695.74 MHz	120 kHz (4 channels)	Linear	2.4 kbps
Meteosat-8 (MSG-1)	2002-2009	3.4°W	to PGS	1686.833 MHz	5.4 MHz	Linear	3.27 Mbps
			HRIT	1695.15 MHz	1.96 MHz	Linear	1.0 Mbps
			LRIT	1691.0 MHz	0.66 MHz	Linear	128 kbps
Meteosat-9 (MSG-2)	2005-2012	~ 0° (TBD)	to PGS	1686.833 MHz	5.4 MHz	Linear	3.27Mbps
			HRIT	1695.15 MHz	1.96 MHz	Linear	1.0 Mbps
			LRIT	1691.0 MHz	0.66 MHz	Linear	128 kbps

Meteosat-10 (MSG-3)	2009-2016	~ 0° (TBD)	to PGS	1686.833 MHz	5.4 MHz	Linear	3.27 Mbps
			HRIT	1695.15 MHz	1.96 MHz	Linear	1.0 Mbps
			LRIT	1691.0 MHz	0.66 MHz	Linear	128 kbps
Meteosat-11 (MSG-4)	2011-2018	~ 0° (TBD)	to PGS	1686.833 MHz	5.4 MHz	Linear	3.27 Mbps
			HRIT	1695.15 MHz	1.96 MHz	Linear	1.0 Mbps
			LRIT	1691.0 MHz	0.66 MHz	Linear	128 kbps

Table A.1.1 (cont.) – Frequency plan of meteorological satellites in geostationary orbit (Sept 2005)

Satellite	Utilisation	Position	Service	Frequency	Bandwidth	Polarisation	Data rate
GOES-9	1995-2005	155°E	to CDA	1676.2 MHz	6.0 MHz	Linear	3.0 Mbps
			GVAR	1685.7 MHz	5.0 MHz	Linear	2.1 Mbps
			WEFAX	1691.0 MHz	1.0 MHz	Linear	1.6 kHz
			DCIS-1	468.8250 MHz	200 kHz	RHC	100 bps
			DCIS-2	468.8375 MHz	200 kHz	RHC	100 bps
GOES-10	1997-2006	135°W	to CDA	1676.2 MHz	6.0 MHz	Linear	3.0 Mbps
			GVAR	1685.7 MHz	5.0 MHz	Linear	2.1 Mbps
			WEFAX	1691.0 MHz	1.0 MHz	Linear	1.6 kHz
			DCIS-1	468.8250 MHz	200 kHz	RHC	100 bps
			DCIS-2	468.8375 MHz	200 kHz	RHC	100 bps
GOES-11	2000-2007	105°W	to CDA	1676.2 MHz	6.0 MHz	Linear	3.0 Mbps
			GVAR	1685.7 MHz	5.0 MHz	Linear	2.1 Mbps
			WEFAX	1691.0 MHz	1.0 MHz	Linear	1.6 kHz
			DCIS-1	468.8250 MHz	200 kHz	RHC	100 bps
			DCIS-2	468.8375 MHz	200 kHz	RHC	100 bps
GOES-12	2001-2008	75°W	to CDA	1676.2 MHz	6.0 MHz	Linear	3.0 Mbps
			GVAR	1685.7 MHz	5.0 MHz	Linear	2.1 Mbps
			WEFAX	1691.0 MHz	1.0 MHz	Linear	1.6 kHz
			DCIS-1	468.8250 MHz	200 kHz	RHC	100 bps
			DCIS-2	468.8375 MHz	200 kHz	RHC	100 bps
GOES-13 (GOES-N)	2004-2011	TBD	to CDA	1676.2 MHz	6.0 MHz	Linear	3.0 Mbps
			GVAR	1685.7 MHz	5.0 MHz	Linear	2.1 Mbps
			WEFAX	1691.0 MHz	1.0 MHz	Linear	1.6 kHz
			DCIS-1	468.8250 MHz	200 kHz	RHC	100 bps
			DCIS-2	468.8375 MHz	200 kHz	RHC	100 bps
GOES-14 (GOES-O)	2007-2014	TBD	to CDA	1676.2 MHz	6.0 MHz	Linear	3.0 Mbps
			GVAR	1685.7 MHz	5.0 MHz	Linear	2.1 Mbps
			WEFAX	1691.0 MHz	1.0 MHz	Linear	1.6 kHz
			DCIS-1	468.8250 MHz	200 kHz	RHC	100 bps
			DCIS-2	468.8375 MHz	200 kHz	RHC	100 bps
GOES-15 (GOES-P)	2008-2015	TBD	to CDA	1676.2 MHz	6.0 MHz	Linear	3.0 Mbps
			GVAR	1685.7 MHz	5.0 MHz	Linear	2.1 Mbps
			WEFAX	1691.0 MHz	1.0 MHz	Linear	1.6 kHz
			DCIS-1	468.8250 MHz	200 kHz	RHC	100 bps
			DCIS-2	468.8375 MHz	200 kHz	RHC	100 bps
MTSAT-1R	2005-2010	140°E	to CDAS	1677.0 MHz	8.2 MHz	Linear	2.7 Mbps
			HiRID	1687.1 MHz	2.0 MHz	Linear	660 kbps
			HRIT	1687.1 MHz	5.3 MHz	Linear	3.5 Mbps
			WEFAX	1691.0 MHz	250 kHz	Linear	1.6 kHz
			LRIT	1691.0 MHz	250 kHz	Linear	75 kbps

			DCS int	468.875 MHz	5.0 kHz	RHC	300 bps
			DCS reg	468.924 MHz	5.0 kHz	RHC	300 bps
MTSAT-2	2010-2015 (TBD)	TBD	to CDAS	1677.0 MHz	8.2 MHz	Linear	2.7 Mbps
			HRIT	1687.1 MHz	5.3 MHz	Linear	3.5 Mbps
			LRIT	1691.0 MHz	250 kHz	Linear	75 kbps
			DCS int	468.875 MHz	5.0 kHz	RHC	300 bps
			DCS reg	468.924 MHz	5.0 kHz	RHC	300 bps
Elektro-L N1	2007-2016	76°E	RDA	7475MHz	30 MHz	RHC	15.36 Mbps
			HRIT	1691.0 MHz	2 MHz	RHC	0.665-1 Mbps
			LRIT	1691.0 MHz	200 kHz	RHC	64-128 kbps
			DCSA	1697.0 MHz	2 MHz	linear	100-1200 bps

Table A.1.1 (cont.) – Frequency plan of meteorological satellites in geostationary orbit (Sept 2005)

Satellite	Utilisation	Position	Service	Frequency	Bandwidth	Polarisation	Data rate
FY-2B	2000-2006	123.5°E	to CDAS	1681.6 MHz	14 MHz	Linear	14 Mbps
			S-VISSR	1687.5 MHz	2.0 MHz	Linear	660 kbps
			WEFAX	1691.0 MHz	260 kHz	Linear	1.6 kHz
FY-2C	2004-2009	105°E	to CDAS	1681.6 MHz	14 MHz	Linear	14 Mbps
			S-VISSR	1687.5 MHz	2.0 MHz	Linear	660 kbps
			LRIT	1691.0 MHz	260 kHz	Linear	150 kbps
FY-2D	2006-2011	TBD	to CDAS	1681.6 MHz	14 MHz	Linear	14 Mbps
			S-VISSR	1687.5 MHz	2.0 MHz	Linear	660 kbps
			LRIT	1691.0 MHz	260 kHz	Linear	150 kbps
FY-2E	2009-2014	TBD	to CDAS	1681.6 MHz	14 MHz	Linear	14 Mbps
			S-VISSR	1687.5 MHz	2.0 MHz	Linear	660 kbps
			LRIT	1691.0 MHz	260 kHz	Linear	150 kbps
FY-2F	2011-2016	TBD	to CDAS	1681.6 MHz	14 MHz	Linear	14 Mbps
			S-VISSR	1687.5 MHz	2.0 MHz	Linear	660 kbps
			LRIT	1691.0 MHz	260 kHz	Linear	150 kbps
INSAT-3A	2003-2008	93.5°E	to CDAS MHz MHz	Linear	526 kbps
			MDD	2599.225 MHz	200 kHz	Linear	10 kHz
INSAT-3D	2007-2014	TBD	to CDAS MHz MHz	Linear	526 kbps
			HRIT MHz kHz	Linear kbps
			LRIT	1691.0 MHz kHz	Linear kbps
Kalpana	2002-2007	74°E	to CDAS MHz MHz	Linear	526 kbps
			MDD	2599.225 MHz	200 kHz	Linear	10 kHz
COMS-1	2008-2015	TBD	to MODAC MHz MHz	Linear	526 kbps
			HRIT MHz kHz	Linear kbps
			LRIT	1691.0 MHz kHz	Linear kbps
COMS-2	2014-2021	TBD	to MODAC MHz MHz	Linear Mbps
			HRIT MHz kHz	Linear kbps
			LRIT	1691.0 MHz kHz	Linear kbps

A1.2 Sunsynchronous satellites

Table A1.2 reports frequency information for sunsynchronous satellites. It is a simplified presentation, especially as concerns the transmission of global data to the high-latitude Command and Data Acquisition stations (only one stream is mentioned, whereas generally there are more). Data Collection Platforms are mentioned only when requiring interrogation. DMSP satellites are not included since the ordinary way to input their data into GOS is through NOAA or by bilateral agreements.

Table A1.2 – Frequency plan of meteorological satellites in sunsynchronous orbit (Sept 2005)

Satellite	Utilisation	LST	Service	Frequency	Bandwidth	Polarisation	Data rate
NOAA-15	1998-2005	06.00 d 18.00 a	GAC/LAC	1702.5 and 1698 or 1707 MHz	2.66 MHz	LHC or RHC	2.66 Mbps
			HRPT	1698 MHz	2.66 MHz	RHC	665.4 kbps
			HRPT bkp	1702.5 MHz	2.66 MHz	LHC	665.4 kbps
			APT	137.5 or 137.62 MHz	34 kHz	RHC	2.1 kHz
			DSB	137.35 or 137.77 MHz kHz	RHC	8.32 kbps

NOAA-16	2000-2006	03.00 d 15.00 a	GAC/LAC	1702.5 and 1698 or 1707 MHz	2.66 MHz	LHC or RHC	2.66 Mbps
			HRPT	1698 MHz	2.66 MHz	RHC	665.4 kbps
			HRPT bkp	1702.5 MHz	2.66 MHz	LHC	665.4 kbps
			APT	failed			
			DSB	137.35 or 137.77 MHz kHz	RHC	8.32 kbps

Table A1.2 (cont.) – Frequency plan of meteorological satellites in sunsynchronous orbit (Sept 2005)

Satellite	Utilisation	LST	Service	Frequency	Bandwidth	Polarisation	Data rate
NOAA-17	2002-2009	10.20 d 22.20 a	GAC/LAC	1702.5 and 1698 or 1707 MHz	2.66 MHz	LHC or RHC	2.66 Mbps
			HRPT	1698 MHz	2.66 MHz	RHC	665.4 kbps
			HRPT bkp	1702.5 MHz	2.66 MHz	LHC	665.4 kbps
			APT	137.5 or 137.62 MHz	34 kHz	RHC	2.1 kHz
			DSB	137.35 or 137.77 MHz kHz	RHC	8.32 kbps
NOAA-18 (NOAA-N)	2005-2010	02.00 d 14.00 a (TBC)	GAC/LAC	1702.5 and 1698 or 1707 MHz	2.66 MHz	LHC or RHC	2.66 Mbps
			HRPT	1698 MHz	2.66 MHz	RHC	665.4 kbps
			HRPT bkp	1702.5 MHz	2.66 MHz	LHC	665.4 kbps
			APT	137.5 or 137.62 MHz	34 kHz	RHC	2.1 kHz
			DSB	137.35 or 137.77 MHz kHz	RHC	8.32 kbps
NOAA-19 (NOAA-N')	2007-2011	02.00 d 14.00 a (TBC)	GAC/LAC	1702.5 and 1698 or 1707 MHz	2.66 MHz	LHC or RHC	2.66 Mbps
			HRPT	1698 MHz	2.66 MHz	RHC	665.4 kbps
			HRPT bkp	1702.5 MHz	2.66 MHz	LHC	665.4 kbps
			APT	137.5 or 137.62 MHz	34 kHz	RHC	2.1 kHz
			DSB	137.35 or 137.77 MHz kHz	RHC	8.32 kbps
NPP	2006-2011	10.30 d 22.30 a	SMD	8212.5 MHz	375 MHz	RHC	300 Mbps
			HRD	7812 MHz	30.8 MHz	RHC	15 Mbps
NPOESS-1	2009-2016	09.30 d 21.30 a	SMD	25.65 GHz	300 MHz	RHC	150 Mbps
			HRD	7812 or 7830 MHz	30.8 MHz	RHC	20 Mbps
			LRD	1706	8 MHz	RHC	3.88 Mbps
NPOESS-2	2011-2018	01.30 d 13.30 a	SMD	25.65 GHz	300 MHz	RHC	150 Mbps
			HRD	7812 or 7830 MHz	30.8 MHz	RHC	20 Mbps
			LRD	1706	8 MHz	RHC	3.88 Mbps
NPOESS-3	2013-2020	05.30 d 17.30 a	SMD	25.65 GHz	300 MHz	RHC	150 Mbps
			HRD	7812 or 7830 MHz	30.8 MHz	RHC	20 Mbps
			LRD	1706	8 MHz	RHC	3.88 Mbps
NPOESS-4	2015-2022	09.30 d 21.30 a	SMD	25.65 GHz	300 MHz	RHC	150 Mbps
			HRD	7812 or 7830 MHz	30.8 MHz	RHC	20 Mbps
			LRD	1706	8 MHz	RHC	3.88 Mbps
NPOESS-5	2018-2025	01.30 d 13.30 a	SMD	25.65 GHz	300 MHz	RHC	150 Mbps
			HRD	7812 or 7830 MHz	30.8 MHz	RHC	20 Mbps
			LRD	1706	8 MHz	RHC	3.88 Mbps
NPOESS-6	2019-2026	05.30 d 17.30 a	SMD	25.65 GHz	300 MHz	RHC	150 Mbps
			HRD	7812 or 7830 MHz	30.8 MHz	RHC	20 Mbps
			LRD	1706	8 MHz	RHC	3.88 Mbps
Metop-1	2006-2010	09.30 d 21.30 a	GDS	7800 MHz	63 MHz	RHC	70 Mbps
			AHRPT	1701.3 MHz (1707 MHz backup)	4.5 MHz	RHC	3.5 Mbps
			LRPT	137.9 MHz	150 kHz	RHC	72 kbps

Metop-2	2010-2015	09.30	GDS	7800 MHz	63 MHz	RHC	70 Mbps
		d	AHRPT	1701.3 MHz (1707 MHz backup)	4.5 MHz	RHC	3.5 Mbps
		21.30 a	LRPT	137.9 MHz	150 kHz	RHC	72 kbps
Metop-3	2015-2020	09.30	GDS	7800 MHz	63 MHz	RHC	70 Mbps
		d	AHRPT	1701.3 MHz (1707 MHz bkp)	4.5 MHz	RHC	3.5 Mbps
		21.30 a	LRPT	137.9 MHz	150 kHz	RHC	72 kbps
Meteor-3M	2001-2005	09.15	DA	8192 GHz	32 MHz	RHC	15.4 Mbps
		d 21.15 a	HRPT-like	1700 GHz	2.0 MHz	RHC	665 kbps
Meteor-M-1	2006-2009	09.15	DA	8.128 or 8.320 GHz	32-250 MHz	RHC	15.4-123 Mbps
		d	HRPT	1700 GHz	2.0 MHz	RHC	665 kbps
		21.15 a	LRPT	137.9 or 137.1 GHz	150 kHz	RHC	72 kbps
Meteor-M-2	2008-2012	09.15	DA	8.128 or 8.320 GHz	32-250 MHz	RHC	15.4-123 Mbps
		d	HRPT	1700 GHz	2.0 MHz	RHC	665 kbps
		21.15	LRPT	137.9 or 137.1 GHz	150 kHz	RHC	72 kbps
		a	DCS	1.69 to 1.71 GHz MHz	RHC	1200-400 bps

Table A1.2 (cont.) – Frequency plan of meteorological satellites in sunsynchronous orbit (Sept 2005)

Satellite	Utilisation	LST	Service	Frequency	Bandwidth	Polarisation	Data rate
FY-1C	1999-2005	6.45 d	CDPT	1708.5 MHz (1695.5 MHz bcp)	5.6 MHz	RHC	1.33 Mbps
		18.45 a	CHRPT	1700.5 MHz (1704.5 GHz bcp)	5.6 MHz	RHC	1.33 Mbps
FY-1D	2002-2006	8.20 d	CDPT	1708.5 MHz (1695.5 MHz bcp)	5.6 MHz	RHC	1.33 Mbps
		20.40 a	CHRPT	1700.5 MHz (1704.5 GHz bcp)	5.6 MHz	RHC	1.33 Mbps
FY-3A	2007-2010	10.00 d	DPT	8025-8215 MHz / 8215- 8400 MHz	120 MHz	RHC	93 Mbps
		22.00 a	MPT	7750-7850 MHz	35 MHz	RHC	18.2 Mbps
			AHRPT	1698-1710 MHz	5.6 MHz	RHC	4.2 Mbps
FY-3B	2010-2013	10.00 d	DPT	8025-8215 MHz / 8215- 8400 MHz	120 MHz	RHC	93 Mbps
		22.00 a	MPT	7750-7850 MHz	35 MHz	RHC	18.2 Mbps
			AHRPT	1698-1710 MHz	5.6 MHz	RHC	4.2 Mbps
FY-3C	2010-2013	10.00 d	DPT	8025-8215 MHz / 8215- 8400 MHz	120 MHz	RHC	93 Mbps
		22.00 a	MPT	7750-7850 MHz	35 MHz	RHC	18.2 Mbps
			AHRPT	1698-1710 MHz	5.6 MHz	RHC	4.2 Mbps
FY-3D	2012-2015	10.00 d	DPT	8025-8215 MHz / 8215- 8400 MHz	120 MHz	RHC	93 Mbps
		22.00 a	MPT	7750-7850 MHz	35 MHz	RHC	18.2 Mbps
			AHRPT	1698-1710 MHz	5.6 MHz	RHC	4.2 Mbps
FY-3E	2014-2017	10.00 d	DPT	8025-8215 MHz / 8215- 8400 MHz	120 MHz	RHC	93 Mbps
		22.00 a	MPT	7750-7850 MHz	35 MHz	RHC	18.2 Mbps
			AHRPT	1698-1710 MHz	5.6 MHz	RHC	4.2 Mbps
FY-3F	2016-2019	10.00 d	DPT	8025-8215 MHz / 8215- 8400 MHz	120 MHz	RHC	93 Mbps
		22.00 a	MPT	7750-7850 MHz	35 MHz	RHC	18.2 Mbps
			AHRPT	1698-1710 MHz	5.6 MHz	RHC	4.2 Mbps
FY-3G	2018-2021	10.00 d	DPT	8025-8215 MHz / 8215- 8400 MHz	120 MHz	RHC	93 Mbps
		22.00 a	MPT	7750-7850 MHz	35 MHz	RHC	18.2 Mbps
			AHRPT	1698-1710 MHz	5.6 MHz	RHC	4.2 Mbps

ANNEX 2

Definitions and acronyms

A2.1 Definition of spectral bands

In this Report use has been made of spectral band definitions which are not fully standardised. Therefore, the following two tables list these definitions as used here. Two tables are provided, one (*Table A2.1.1*) for the bands used for Remote Sensing, one (*Table A2.1.2*) for the sub-division of the band used in radar technology.

Table A2.1 - Bands of the electromagnetic spectrum exploited for Remote Sensing

UV	Ultra-Violet	0.01 - 0.38 μm
B	Blue	0.436 μm
G	Green	0.546 μm
R	Red	0.700 μm
VIS	Visible	0.38 - 0.78 μm
NIR	Near Infra-Red	0.78 - 1.30 μm
VNIR	Visible and Near Infra-Red (VIS + NIR)	0.38 - 1.3 μm
SWIR	Short-Wave Infra-Red	1.3 - 3.0 μm
SW	Short Wave	0.2 - 4.0 μm
LW	Long Wave	4 - 100 μm
MWIR	Medium-Wave Infra-Red	3.0 - 6.0 μm
TIR	Thermal Infra-Red	6.0 - 15.0 μm
IR	Infra-Red (MWIR + TIR)	3 - 15 μm
FIR	Far Infra-Red	15 μm - 1 mm (= 300 GHz)
Sub-mm	Submillimetre wave (part of FIR)	3000 - 300 GHz (or 0.1 - 1 mm)
Mm	Millimetre wave (part of MW)	300 - 30 GHz (or 1 - 10 mm)
MW	Microwave	300 - 1 GHz (or 0.1 - 30 cm)

Table A2.1 - Bands used in radar technology (according to ASPRS, American Society for Photogrammetry and Remote Sensing)

Band	Frequency range	Wavelength range
P	220 - 390 MHz	77 -136 cm
UHF	300 - 1000 MHz	30 -100 cm
L	1 - 2 GHz	15 - 30 cm
S	2 - 4 GHz	7.5 - 15 cm
C	4 - 8 GHz	3.75 - 7.5 cm
X	8 - 12.5 GHz	2.4 - 3.75 cm
Ku	12.5 - 18 GHz	1.67 - 2.4 cm
K	18 - 26.5 GHz	1.18 - 1.67 cm
Ka	26.5 - 40 GHz	0.75 - 1.18 cm
V	40 - 75 GHz	4.0 - 7.5 mm
W	75 - 110 GHz	2.75 - 4.0 mm

A2.2 List of acronyms (except for instruments, that are listed in Annex 3)

ADEOS	Advanced Earth Observing Satellite
ADM-Aeolus	Atmospheric Dynamics Mission – Aeolus
AND	ALOS Data Node
ALOS	Advanced Land Observing Satellite
AMP	Applications of Meteorology Programme
AO	Announcement of Opportunity
APT	Automatic Picture Transmission
AREP	Atmospheric Research and Environment Programme
ATN	Advanced TIROS-N
ATOVS	Advanced TIROS Operational Vertical Sounder
ATS	Application Technology Satellite
BUFR	Binary Universal Form for data Representation
CALIPSO	Cloud-Aerosol Lidar and Infrared Pathfinder Satellite Observations
CBS	Commission for Basic Systems (of WMO)
CDA	Command and Data Acquisition station
CDAS	Command and Data Acquisition Station
CDPT	China Delayed Picture Transmission
CERES	Clouds and the Earth's Radiant Energy System
CGMS	Coordination Group for Meteorological Satellites
CHAMP	Challenging Mini-Satellite Payload
CHRPT	China High Resolution Picture Transmission
CM	Consultative Meetings on High Level Policy on Satellite Matters (of WMO)
CMA	China Meteorological Department
CNES	Centre National d'Etudes Spatiales
CNSA	China National Space Agency
COMS	Communication, Oceanography and Meteorology Satellite
COSMIC	Constellation Observing System for Meteorology, Ionosphere & Climate
DCP	Data Collection Platform
DLR	Deutsches Zentrum für Luft- und Raumfahrt (German Aerospace Centre)
DMSP	Defense Meteorological Satellite Program
DoD	Department of Defense (of the USA)
DPT	Delayed Picture Transmission
DSB	Direct Sounder Broadcast
DVB	Digital Video Broadcast
Earth-CARE	Earth Clouds, Aerosol and Radiation Explorer
EDC	EROS Data Centre (of the US Geological Survey)
EOC	Earth Observation Center (of JAXA)
EOS	Earth Observing System
EOSDIS	Earth Observing System - Data and Information System
EPS	EUMETSAT Polar System
ERBS	Earth Radiation Budget Satellite
ERS	European Remote-sensing Satellite
ESA	European Space Agency
ESSA	Environmental Science and Services Administration
ESSP	Earth System Science Pathfinder program
EUMETSAT	European Organisation for the exploitation of meteorological satellites
FGGE	First GARP Global Experiment
FY	Feng-Yun (FY-1 and FY-3 sunsynchronous, FY-2 geostationary)
G/T	Overall merit figure of a receiving system (dB/K)
GAC	Global Area Coverage
GARP	Global Atmospheric Research Programme
GDS	Global Data Stream

GEO	Geostationary Earth Orbit
GMES	Global Monitoring for Environment and Security
GMS	Geosynchronous Meteorological Satellite
GOCE	Gravity Field and Steady-State Ocean Circulation Explorer
GOES	Geostationary Operational Environmental Satellite
GOMS	Geostationary Operational Meteorological Satellite
GOS	Global Observing System
GOSAT	Green-house gas Observing Satellite
GPM	Global Precipitation Measurement mission
GRACE	Gravity Recovery and Climate Experiment
GTS	Global Telecommunication System (of the WMO WWW)
GVAR	GOES Variable Data Format
HiRID	High Resolution Imager Data
HRIDS	High Resolution Image Dissemination Service
HRIT	High Rate Information Transmission
HRPT	High Resolution Picture Transmission
HRUS	High Rate User Station
HWRP	Hydrology and Water Resources Programme
HYDROS	Hydrosphere State Mission
IFOV	Instantaneous Field Of View
IGeoLab	International Geostationary Laboratory
IMD	India Meteorological Department
INDOEX	Indian Ocean Experiment
INSAT	Indian National Satellite
IOC	Intergovernmental Oceanographic Commission (of UNESCO)
IRS	Indian Remote-sensing Satellite
ISRO	India Space Research Organisation
ITOS	Improved TIROS Operational System
JASON	Joint Altimetry Satellite Oceanography Network
JAXA	Japan Aerospace Exploration Agency (formerly NASDA)
JERS	Japanese Earth Resources Satellite
JMA	Japan Meteorological Agency
JPS	Joint Polar System
KARI	Korea Aerospace Research Institute
KMA	Korea Meteorological Administration
KNMI	Koninklijk Nederlands Meteorologisch Instituut
LAC	Local Area Coverage
LEO	Low Earth Orbit
LRIT	Low Rate Information Transmission
LRUS	Low Rate User Station
LST	Local Solar Time
MAP	Mesoscale Alpine Programme
MDD	Meteorological Data Distribution
MDUS	Medium-scale Data Utilisation Station
MetSat	Meteorological Satellite (re-named Kalpana)
MODSAC	Meteo/Ocean Data Application Center
MOP	Meteosat Operational Programme
MOS	Marine Observatory Satellite
MPT	Medium-resolution Picture Transmission
MSG	Meteosat Second Generation
MTG	Meteosat Third Generation
MTP	Meteosat Transition Programme
MTSAT	Multi-functional Transport Satellite
NASA	National Aeronautics and Space Administration (of USA)

NASDA	National Space Development Agency (of Japan)
NOAA	National Oceanic and Atmospheric Administration
NPOESS	National Polar-orbiting Operational Environmental Satellite System
NPP	NPOESS Preparatory Program
NRSA	National Remote Sensing Agency (of India)
NRT	Near-Real-Time
NSIDC	National Snow and Ice Data Center
NWP	Numerical Weather Prediction
OCO	Orbiting Carbon Observatory
OPAG-IOS	Open Programme Area Group on the Integrated Observing Systems
OSTM	Ocean Surface Topography Mission
PAC	Processing & Archiving Centre (of ESA/Envisat)
PAF	Processing & Archiving Facilities (of ESA/ERS)
PARASOL	Polarisation et Anisotropie des Réflectances au sommet de l'Atmosphère, couplées avec un Satellite d'Observation emportant un Lidar
PDUS	Primary Data User Station
PGS	Primary Ground Station
POEM	Polar Orbit Earth-observation Mission
POES	Polar-orbiting Operational Environmental Satellite
R & D	Research and Development
RDA	Raw Data Acquisition station
RosHydroMet	Hydro-Meteorological Service of the Russian Federation
RosKosmos	Aeronautics and Space Agency of the Russian Federation
RTH	Regional Telecommunication Hub (of the WMO WWW)
SAR	Synthetic Aperture Radar
SDUS	Secondary Data User Station
SMD	Stored Mission Data
SMOS	Soil Moisture and Ocean Salinity
SMS	Synchronous Meteorological Satellite
SNR	Signal-to-Noise Ratio
SPOT	Satellite Pour l'Observation de la Terre
SSP	Sub Satellite Point
SWARM	The Earth's Magnetic Field and Environment Explorers
TIROS	Television and Infra-Red Observation Satellite
TOPEX	Topography Experiment
TOS	TIROS Operational System
TOVS	TIROS Operational Vertical Sounder
TRMM	Tropical Rainfall Measuring Mission
UARS	Upper Atmosphere Research Satellite
USGS	US Geological Survey
WCP	World Climate Programme
WCRP	World Climate Research Programme
WDPMP	Natural Disaster Prevention and Mitigation Programme
WEFAX	Weather Facsimile
WMO	World Meteorological Organization
WSP	WMO Space Programme
WWW	World Weather Watch

ANNEX 3

Instruments of the space-based component of GOS

This Annex lists all instruments that have been mentioned in this Report, and provides somewhat detailed information on several instruments that are currently being flown, or are planned to be flown, on the satellites constituting the space-based component of the Global Observing System (GOS). Data transmission payloads (except for DCP) and orbitography/navigation systems are not included.

The information on instruments of operational meteorological satellites (those handled in Sections 2 and 3) is provided in *Annex A3.1*; that one on instruments of R&D satellites (Section 4) in *Annex A3.2*.

The information consists of two records:

- The list of instruments (*Table A3.1.1* and *Table A3.2.1* for meteorological and R&D satellites respectively), recording the corresponding satellites and the period of utilisation of the instrument through the various satellites of a series.
- Instrument sheets, only for *Earth sensors*, i.e., not for *in situ* environment monitoring at platform level, solar observation, data collection systems, data distribution and search & rescue). Only current and planned instruments are considered. The instruments for which sheets are provided are highlighted in the last column of Table A3.1.1 and Table A3.2.1. In addition, in the case of meteorological satellites, a *Table A3.1.2* aggregates the instruments by type of mission. A corresponding table for instruments of R&D satellites is not provided, due to the extreme variability.

The instrument sheets collect the information as available up to end-September 2005. The basis of information consists of the reports collected at the CGMS meetings, in certain case up to shortly before CGMS-XXXIII. Wide integration has been necessary by consulting other sources of public domain (generally the web sites of CGMS members and, in cascade, the sites of individual projects). It is complained that a trend is detectable towards web sites very spectacular, clearly oriented towards the general public, but the level of technical detail is progressively degraded. ***CGMS members should correct this situation.*** Also, the reports to CGMS on the status of satellites and plans are very late: the majority is not yet posted 10 days before CGMS XXXIII. ***This situation also should be corrected.***

The degree of detail of the various instrument sheets changes with the priority of the mission in respect of WMO objectives (first priority: imagery and sounding), with the development status (from operational to planned) and with the availability of information.

When, for an instrument, there are upgraded flight models co-existing with previous flight models, the instrument sheet reports the latest version, even if the satellite has not yet been launched.

The purpose of this Appendix is to constitute a framework to facilitate updating of information exchanged within CGMS. The instrument sheets can be regarded as templates providing guidance for checking the current content, updating as necessary, and filling possible gaps.

The information collected in this document has been used in the Main Text of the Report to compare the degree of service provided by the various satellites concurring to implement GOS so as to control whether the composite system is not only compliant with requirements in terms of number and distribution of satellites, ma also in terms of homogeneity of data quality from different sources supposed to be used in combination. This analysis is limited to operational meteorological satellites (Sections 2.9 and 2.10 for geostationary, 3.8 and 3.9 for sunsynchronous).

A3.1 Operational meteorological satellites

Table A3.1.1 - List of instruments, corresponding satellites and utilisation period

Acronym	Full name	Satellites	Utilisation	Sheet
ABI	Advanced Baseline Imager	GOES-R and follow-on	2012 →	X
AC	Radiation Budget Sensor	Meteor-1 1 to 28	1969-1978	
ALT	Radar Altimeter	NPOESS-3/6	2013-2026	X
AMSU-A	Advanced Microwave Sounding Unit - A	NOAA 15 to 19 Metop 1/2	1998-2012 2006-2011	X
AMSU-B	Advanced Microwave Sounding Unit - B	NOAA-15/16/17	1998-2007	X
APS	Aerosol Polarimetry Sensor	NPOESS-1/4	2009-2022	X
APT	Automatic Picture Transmission	TIROS-8, ESSA-2/4/6/8 ITOS-1, NOAA-1	1967-1976 1970-1971	
ARGOS-DCS	ARGOS Data Collection and localisation System	TIROS-N, NOAA 6 to 19 NPOESS-1/3/4/6 Metop 1 to 3	1978-2012 2006-2026 2006-2020	
ASCAT	Advanced Scatterometer	Metop 1/2/3	2006-2020	X
ATMS	Advanced Technology Microwave Sounder	NPP, NPOESS-1/3/4/6	2006-2026	X
AVCS	Advanced Vidicon Camera System	ESSA-3/5/7/9, ITOS-1, NOAA-1	1966-1971	
AVHRR/3	Advanced Very High Resolution Radiometer	TIROS-N, NOAA 6 to 19 Metop-1/2/3	1978-2012 2006-2020	X
CCD	Charge Coupled Device Camera	INSAT-2E, INSAT-3A	1999-2008	X
CMIS	Conical-scanning Microwave Imager/Sounder	NPOESS 1 to 6	2009-2026	X
CrIS	Cross-track Infrared Sounder	NPP, NPOESS-1/3/4/6	2006-2026	X
DCIS	Data Collection and Interrogation Service	SMS-1/2, GOES 1 to 15 GOMS-1 and follow-on	1974-2015 1994 →	
DCS	Data Collection Service	Meteosat 1 to 11 GMS 1 to 5, MTSAT-1/2 FY-2 A to F INSAT-1A to 3D, Kalpana	1977-2018 1977-2014 1997-2015 1982-2014	
ERBE	Earth Radiation Budget Experiment	NOAA-9 and NOAA-10	1984-2001	
ERBS	Earth Radiation Budget Sensor	NPOESS-2/5	2011-2025	X
FPR	Flat Plate Radiometer	TIROS-2/3/4/7, ESSA- 1/3/5/7/9 ITOS-1, NOAA-1	1960-1972 1970-1971	
GEOSAR	Geostationary Search and Rescue	GOES 8 to 15 Meteosat 8 to 11 (MSG) INSAT-3 A and D Elektro-L and follow-on	1994-2015 2002-2018 2003-2010 2007 →	
GERB	Geostationary Earth Radiation Budget	Meteosat 8 to 11 (MSG)	2002-2018	X
GGAK-M	Space Environment Monitor	Meteor-M 1/2	2006-2013	
GLM	Geostationary Lightning Mapper	GOES-R and follow-on	2012 →	X
GOME-2	Global Ozone Monitoring Experiment - 2	Metop 1/2/3	2006-2020	X
GPSOS	Global Positioning System Occultation Sensor	NPOESS-2/5	2011-2025	X
GRAS	GNSS Receiver for Atmospheric Sounding	Metop 1/2/3	2006-2020	X
GVHHR	Geostationary Very High Resolution Radiometer	ATS-6	1974	
HES	Hyperspectral Environmental Suite	GOES-R and follow-on	2012 →	X
HIRS/4	High-resolution Infra Red Sounder	TIROS-N, NOAA 6 to 19 Metop-1/2	1978-2012 2006-2016	X
IASI	Infrared Atmospheric Sounding Interferometer	Metop 1/2/3	2006-2020	X
IMAGER	GOES Imager INSAT Imager	GOES 8 to 15 INSAT-3D	1994-2015 2007-2014	X X
IR	Infrared Instrument	Meteor-1 1 to 28, Meteor-2 1 to 22	1969-1994	
IRAS	Infra Red Atmospheric Sounder	FY-3 1 to 7	2006-2021	X
IRFS-2	IR Sounding Spectrometer	Meteor-M-2	2008-2012	X
JAMI/IMAGER	Japanese Advanced Meteorological Imager	MTSAT 1/2	2005-2014	X
KGI-4C	Space Environment Monitor (particles)	Meteor-3M	2001-2005	

Table A3.1.1 (cont.) - List of instruments, corresponding satellites and utilisation period

Acronym	Full name	Satellites	Utilisation	Sheet
Klimat	Infrared Imaging Radiometer	Meteor-3 1 to 7, Meteor-3M	1985-2005	X
KMSS	High-resolution VIS/NIR radiometer	Meteor-M 1/2	2006-2013	X
MERSI	Medium Resolution Spectral Imager	FY-3 A to G	2006-2021	X
MHS	Microwave Humidity Sounding	NOAA-18/19 Metop 1/2/3	2005-2012 2006-2020	X
MI	Meteorological Imager	COMS-1/2	2008-2021	X
MIVZA	Imaging microwave radiometer	Meteor-3M	2001-2005	
MR-2000M1	Television Camera	Meteor-3 1 to 7, Meteor-3M	1985-2005	X
MR-900B	Television Camera	Meteor-3 1 to 7	1985-1995	
MRIR	Medium Resolution Infrared Radiometer	TIROS-2/3/4/7	1960-1967	
MSGI-5EI	Space Environment Monitor (irradiances)	Meteor-3M	2001-2005	
MSSCC	Multi-color Spin Scan Cloud Camera	ATS-3	1967-1975	
MSU	Microwave Sounding Unit	TIROS-N, NOAA 6 to 14	1978-2003	
MSU-E	High-resolution VIS/NIR radiometer	Meteor-3M	2001-2005	X
MSU-GS	Elektro-GOMS Imager	Elektro-L and follow-on	2006 →	X
MSU-MR	VIS/IR Imaging Radiometer	Meteor-M 1/2	2006-2013	X
MTG imager(s)	TBD	Meteosat Third Generation	2015 →	X
MTG lightning	TBD	Meteosat Third Generation	2015 →	X
MTG sounder	TBD	Meteosat Third Generation	2015 →	X
MTVZA	Imaging/Sounding Microwave Radiometer	Meteor-3M and Meteor-M 1/2	2001-2013	X
MVIRI	Meteosat Visible Infra-Red Imager	Meteosat 1 to 7	1977-2008	X
MVISR	Multichannel Visible Infrared Scanning Radiometer	FY-1 A to D	1988-2006	X
MWHS	Micro-Wave Humidity Sounder	FY-3 A to G	2006-2021	X
MWRI	Micro-Wave Radiation Imager	FY-3 A to G	2006-2021	X
MWTS	Micro-Wave Temperature Sounder	FY-3 A to G	2006-2021	X
OMPS	Ozone Mapping and Profiler Suite	NPP, NPOESS-2/5	2006-2025	X
OS	Ocean Sensor	COMS-1/2	2008-2021	X
Radiomet	Radio-occultation sounder	Meteor-M 1/2	2006-2013	X
RMK-2	Space Environment Monitor	Meteor-2 1 to 22, Meteor-3 1 to 6	1975-1994	
RMS	Radiation Measurement System	GOMS-1/2 and follow-on	1994 →	
SAGE-III	Stratospheric Aerosol and Gas Experiment – III	Meteor-3M	2001-2005	X
SARSAT	Search and Rescue Satellite-Aided Tracking System	NOAA 8 to 19 except 12 NPOESS 1 to 6 Metop 1/2	1983-2012 2009-2026 2006-2016	
SBUV/2	Solar Backscatter Ultraviolet / 2	NOAA 9 to 19 except 12/15	1984-2012	X
ScaRaB	Scanner for Radiation Budget	Meteor-3 7	1994-1995	
SEM (GEO)	Space Environment Monitor	SMS-1/2, GOES 1 to 15 GMS 1 to 5 FY-2 A to F	1974-2015 1977-2003 1997-2015	
SEM (LEO)	Space Environment Monitor	TIROS-N, NOAA 6 to 19 Metop 1/2 FY-1 A to D, FY-3 A to G	1978-2012 2006-2016 1988-2021	
SESS	Space Environment Sensor Suite	NPOESS-2/5	2011-2025	
Severjanin	X-band Synthetic Aperture Radar	Meteor-M 1/2	2006-2013	X
SEVIRI	Spinning Enhanced Visible Infra-Red Imager	Meteosat 8 to 11 (MSG)	2002-2018	X
SFM-2	Ultraviolet spectrometer	Meteor-3M	2001-2005	
SM	Infrared Sounding Radiometer	Meteor-2 1 to 22	1975-1994	
SOUNDER	GOES Sounder INSAT Sounder	GOES 8 to 15 INSAT-3D	1994-2015 2007-2014	X X
SPM	Solar Proton Monitor	NOAA 2 to 5	1972-1979	
SR	Scanning Radiometer	ITOS-1, NOAA 1 to 5	1970-1979	
SSCC	Spin Scan Cloud Camera	ATS-1	1966-1972	

Table A3.1.1 (cont.) - List of instruments, corresponding satellites and utilisation period

Acronym	Full name	Satellites	Utilisation	Sheet
SSM/I	Special Sensor Microwave – Imager	DMSP F-8/10/11/13/14/15	1987-2006	X
SSM/T	Special Sensor Microwave – Temperature	DMSP F 4 to 15	1979-2006	X
SSM/T2	Special Sensor Microwave – Humidity	DMSP F-11/12/14/15	1991-2006	X
SSMIS	Special Sensor Microwave – Imager/Sounder	DMSP F 16 to 20	2003-2015	X
SSU	Stratospheric Sounding Unit	TIROS-N, NOAA 6 to 14	1978-2003	
STR	Scanning TV Radiometer	GOMS-1	1994-2000	
S-VISSR	Stretched Visible-Infrared Spin Scan Radiometer	FY-2 A to F	1997-2015	X
SXI	Solar X-ray Imager	GOES 12 to 15	2001-2015	
TOMS	Total Ozone Mapping Spectrometer	Meteor-3 6	1991-1993	
TOU/SBUS	Total Ozone Unit & Solar Backscatter Ultraviolet Sounder	FY-3 A to G	2006-2021	X
TSIS	Total Solar Irradiance Sensor	NPOESS-3/6	2013-2026	
TV	Television Camera	Meteor-1 1 to 28, Meteor-2 1 to 22	1969-1994	
VAS	VISSR Atmospheric Sounder	GOES 4 to 7	1980-1995	
VCS	Vidicon Camera System	TIROS 1 to 10, ESSA-1	1960-1967	
VHRR (GEO)	Very High Resolution Radiometer	INSAT-1A to 3A, Kalpana	1982-2010	X
VHRR (LEO)	Very High Resolution Radiometer	NOAA 2 to 5	1972-1979	
VIIRS	Visible/Infrared Imager Radiometer Suite	NPP, NPOESS 1 to 6	2006-2026	X
VIRR	Visible and Infra Red Radiometer	FY-3 A to G	2006-2021	X
VISSR	Visible-Infrared Spin Scan Radiometer	SMS-1/2, GOES-1/2/3 GMS 1 to 5	1974-1980 1977-2003	
VTPR	Vertical Temperature Profile Radiometer	NOAA 2 to 5	1972-1979	

Table A3.1.2 - List of the provided instrument sheets ordered by type of sensor and satellite

GEOSTATIONARY	Meteosat	GOES	MTSAT	Elektro-L	FY-2	INSAT-3A and 3D	Kalpana	COMS
Imager	MVIRI, SEVIRI	IMAGER	JAMI	MSU-GS	S-VISSR	VHRR, CCD, IMAGER	VHRR	MI, OS
Advanced imager	MTG Imager	ABI						
Sounder		SOUNDER				SOUNDER		
Advanced sounder	MTG Sounder	HES						
Earth radiation	GERB							
Lightning mapper	MTG Lightning	GLM						

SUNSYNCHRONOUS	NOAA	DMSP	NPOESS	Metop	Meteor-3M / Meteor-M	FY-1 / FY-3
VIS/IR imager	AVHRR/3			AVHRR/3	MR-2000M1, Klimat, MSU-MR	MVISR, VIRR
VIS/IR advanced imager			VIIRS		MSU-E, KMSS	MERSI
IR sounder	HIRS 3/4			HIRS/4		IRAS
IR advanced sounder			CrIS	IASI	IRFS-2	
MW imager		SSM/I			MIVZA	MWRI
MW imager/sounder		SSMIS	CMIS		MTVZA	
MW sounder (temperature)	AMSU-A	SSM/T		AMSU-A		MWTS
MW sounder (humidity)	AMSU-B, MHS	SSM/T2		MHS		MWHS
MW advanced sounder			ATMS	~ATMS		
Radio-occultation			GPSOS	GRAS	Radiomet	

sounder						
Altimeter			ALT			
Scatterometer				ASCAT		
SAR					Severjanin	
Aerosol			APS		SAGE-III	
Earth radiation budget			ERBS			
Ozone	SBUS/2		OMPS	GOME-2	SFM-2	TOU/SBUS

ABI	Advanced Baseline Imager
Satellites	GOES-R (to become GOES-16) and follow-on
Status (Sept 2005)	Being defined – To be utilised from 2012 onward
Mission	Multi-purpose VIS/IR imagery and wind derivation by tracking clouds and water vapour features
Instrument type	16-channel VIS/IR radiometer
Coverage/cycle	Full disk each 15 min, 3000x5000 km ² ("CONUS", Continental U.S.) in 5 min, 1000x1000 km ² in 30 s
Resolution (s.s.p.)	0.5 km at 0.64 μm, 1.0 km at 0.47, 0.86 and 1.61 μm, 2 km in the remaining 12 channels

Central wavelength	Bandwidth	Radiometric accuracy (NEΔT or SNR)
470 nm	40 nm	300 @ 100 % albedo
640 nm	100 nm	300 @ 100 % albedo
860 nm	40 nm	300 @ 100 % albedo
1380 nm	30 nm	300 @ 100 % albedo
1610 nm	60 nm	300 @ 100 % albedo
2260 nm	50 nm	300 @ 100 % albedo
3.90 μm	0.20 μm	0.1 K @ 300 K
6.15 μm	0.90 μm	0.1 K @ 300 K
7.00 μm	0.40 μm	0.1 K @ 300 K
7.40 μm	0.20 μm	0.1 K @ 300 K
8.50 μm	0.40 μm	0.1 K @ 300 K
9.70 μm	0.20 μm	0.1 K @ 300 K
10.3 μm	0.50 μm	0.1 K @ 300 K
11.2 μm	0.80 μm	0.1 K @ 300 K
12.3 μm	1.00 μm	0.1 K @ 300 K
13.3 μm	0.60 μm	0.3 K @ 300 K

ALT	Radar Altimeter
Satellites	NPOESS 3 and 6
Status (Sept 2005)	Design being consolidated – To be utilised in the period 2013 to ~ 2026
Mission	Ocean topography, significant wave height, wind speed
Instrument type	Two-frequency (5.3 and 13.575 GHz) radar altimeter
Scanning technique	Nadir-only viewing, sampling at km intervals along track
Coverage/cycle	22640 measurements/day at 25 km intervals – Global coverage (25 km average spacing) in 30 days
Resolution	25 km IFOV

AMSU-A	Advanced Microwave Sounder Unit - A
Satellites	NOAA 15 to 19 - Metop 1 and 2
Status (Sept 2005)	Operational – Utilisation period: 1998 to ~ 2012 on NOAA, 2006 to ~ 2020 on Metop
Mission	Temperature sounding in nearly-all-weather conditions
Instrument type	15-channel MW radiometer
Scanning technique	Cross-track: 30 steps of 48 km ssp, swath 2250 km - Along-track: one 48-km line each 8 s
Coverage/cycle	Near-global coverage twice/day
Resolution (s.s.p.)	48 km IFOV

Central frequency (GHz)	Bandwidth (MHz)	Polarisation	Radiometric accuracy (NE Δ T)
23.800	270	V	0.30 K
31.400	180	V	0.30 K
50.300	180	V	0.40 K
52.800	400	V	0.25 K
53.596 \pm 0.115	170	H	0.25 K
54.400	400	H	0.25 K
54.940	400	V	0.25 K
55.500	330	H	0.25 K
$f_0 = 57.290344$	330	H	0.25 K
$f_0 \pm 0.217$	78	H	0.40 K
$f_0 \pm 0.3222 \pm 0.048$	36	H	0.40 K
$f_0 \pm 0.3222 \pm 0.022$	16	H	0.60 K
$f_0 \pm 0.3222 \pm 0.010$	8	H	0.80 K
$f_0 \pm 0.3222 \pm 0.0045$	3	H	1.20 K
89.000	2000	V	0.50 K

AMSU-B	Advanced Microwave Sounder Unit - B
Satellites	NOAA 15 to 17
Status (Sept 2005)	Operational – Utilisation period: 1998 to ~ 2007
Mission	Humidity sounding in nearly-all-weather conditions. Also precipitation
Instrument type	5-channel MW radiometer
Scanning technique	Cross-track: 90 steps of 16 km ssp, swath 2250 km - Along-track: one 16-km line each 8/3 s
Coverage/cycle	Near-global coverage twice/day
Resolution (s.s.p.)	16 km IFOV

Central frequency (GHz)	Bandwidth (MHz)	Polarisation	Radiometric accuracy (NE Δ T)
89.0	1000	V	0.37 K
150.0	1000	V	0.84 K
183.31 \pm 7.0	2000	V	0.60 K
183.31 \pm 3.0	1000	V	0.70 K
183.31 \pm 1.0	500	V	1.06 K

APS	Aerosol Polarimetry Sensor
Satellites	NPOESS 1 and 4
Status (Sept 2005)	Being designed – To be utilised in the period 2009 to ~ 2022
Mission	Aerosol optical thickness, size distribution and shape
Instrument type	9-channel VIS/NIR/SWIR polarimeter with multi-angle capability
Scanning technique	Along-track viewing only, fore- and aft- $\pm 60^\circ$ (... steps of $^\circ$), one full measurement eachkm
Coverage/cycle measurements/day at km intervals – Global coverage (25 km average spacing) in 30 days
Resolution	10 km IFOV

Central wavelength	Bandwidth	Polarisations	Radiometric accuracy (SNR)
412 nm	20 nm	0, 45, 90 and 135 degrees @ % albedo
445 nm	18 nm	0, 45, 90 and 135 degrees @ % albedo
488 nm	20 nm	0, 45, 90 and 135 degrees @ % albedo
555 nm	20 nm	0, 45, 90 and 135 degrees @ % albedo
672 nm	20 nm	0, 45, 90 and 135 degrees @ % albedo
746 nm	15 nm	0, 45, 90 and 135 degrees @ % albedo

865 nm	39 nm	0, 45, 90 and 135 degrees @ % albedo
1240 nm	20 nm	0, 45, 90 and 135 degrees @ % albedo
1378 nm	15 nm	0, 45, 90 and 135 degrees @ % albedo
1610 nm	60 nm	0, 45, 90 and 135 degrees @ % albedo
2250 nm	50 nm	0, 45, 90 and 135 degrees @ % albedo

ASCAT	Advanced Scatterometer
Satellites	Metop 1 to 3
Status (Sept 2005)	Close to launch – To be utilised in the period: 2006 to ~ 2020
Mission	Sea surface wind vector. Also large-scale soil moisture
Instrument type	C-band radar scatterometer (5.255 GHz), side looking both left and right. 3 antennas on each side
Scanning technique	Two 500-km swaths separated by a 700-km gap along-track. 3 looks each pixel (45, 90 and 135° azimuth)
Coverage/cycle	Global coverage in 1.5 days
Resolution	Best quality: 50 km – standard quality: 25 km – basic sampling: 12.5 km

ATMS	Advanced Technology Microwave Sounder
Satellites	NPP, NPOESS 1 to 6
Status (Sept 2005)	Close to launch – To be utilised in the period 2006 to ~ 2026
Mission	Temperature and humidity sounding in nearly-all-weather conditions. Also precipitation
Instrument type	22-channel MW radiometer
Scanning technique	Cross-track: 96 steps of 16 km ssp, swath 2200 km - Along-track: one 16-km line each 8/3 s
Coverage/cycle	Near-global coverage twice/day
Resolution (s.s.p.)	16 km for channels 165-183 GHz, 32 km for channels 50-90 GHz, 75 km for channels 23-32 GHz

Central frequency (GHz)	Bandwidth (MHz)	Quasi-polarisation	Radiometric accuracy (NE Δ T)
23.800	270	QV	0.90 K
31.400	180	QV	0.90 K
50.300	180	QH	1.20 K
51.760	400	QH	0.75 K
52.800	400	QH	0.75 K
53.596 \pm 0.115	170	QH	0.75 K
54.400	400	QH	0.75 K
54.940	400	QH	0.75 K
55.500	330	QH	0.75 K
$f_0 = 57.290344$	330	QH	0.75 K
$f_0 \pm 0.217$	78	QH	1.20 K
$f_0 \pm 0.3222 \pm 0.048$	36	QH	1.20 K
$f_0 \pm 0.3222 \pm 0.022$	16	QH	1.50 K
$f_0 \pm 0.3222 \pm 0.010$	8	QH	2.40 K
$f_0 \pm 0.3222 \pm 0.0045$	3	QH	3.60 K
89.5	5000	QV	0.50 K
165.5	3000	QH	0.60 K
183.31 \pm 7.0	2000	QH	0.80 K
183.31 \pm 4.5	2000	QH	0.80 K
183.31 \pm 3.0	1000	QH	0.80 K
183.31 \pm 1.8	1000	QH	0.80 K
183.31 \pm 1.0	500	QH	0.90 K

AVHRR/3	Advanced Very High Resolution Radiometer / 3
Satellites	TIROS-N, NOAA 6 to 19 - Metop 1 to 3
Status (Sept 2005)	Operational – Utilisation period: 1978 to ~ 2012 on NOAA, 2006 to ~ 2020 on Metop

Mission	Multi-purpose VIS/IR imagery
Instrument type	6-channel VIS/IR radiometer (channel 1.6 and 3.7 alternative)
Scanning technique	Cross-track: 2048 pixel of 800 m ssp, swath 2900 km - Along-track: six 1.1-km lines/s
Coverage/cycle	Global coverage twice/day (IR) or once/day (VIS)
Resolution (s.s.p.)	1.1 km IFOV

Central wavelength	Spectral interval	Radiometric accuracy (NE Δ T or SNR)
0.630 μm	0.58 - 0.68 μm	9 @ 0.5 % albedo
0.862 μm	0.725 - 1.00 μm	9 @ 0.5 % albedo
1.61 μm	1.58 - 1.64 μm	20 @ 0.5 % albedo
3.74 μm	3.55 - 3.93 μm	0.12 K @ 300 K
10.80 μm	10.3 - 11.3 μm	0.12 K @ 300 K
12.00 μm	11.5 - 12.5 μm	0.12 K @ 300 K

CCD	Charge-Coupled Device Camera
Satellites	INSAT-2E and INSAT-3A
Status (Sept 2005)	Operational – Utilisation period: 1999 to ~ 2008
Mission	Cloud imagery
Instrument type	3-channel VIS camera
Coverage/cycle	10° x 10° each 3 hours. More frequently on demand. Daylight operation only
Resolution (s.s.p.)	1.0 km

Central wavelength	Spectral interval	Radiometric accuracy (SNR)
0.71 μm	0.63 - 0.79 μm @ ... % albedo
0.81 μm	0.77 – 0.86 μm @ ... % albedo
1.62 μm	1.55 – 1.70 μm @ ... % albedo

CMIS	Conical-scanning Microwave Imager/Sounder
Satellites	NPOESS 1 to 6
Status (Sept 2005)	Design being consolidated – Utilisation period: 2009 to ~ 2026
Mission	Multi-purpose MW imager with temperature/humidity sounding channels for improved precipitation
Instrument type	63-frequency, 77-channel MW radiometer
Scanning technique	Conical: 53.6- 58.1° zenith angle, swath 1700 km – Scan rate: 31.6 scan/min = 12.5 km/scan
Coverage/cycle	Global coverage once/day
Resolution (constant)	Changing with frequency, consistent with antenna diameters of 2.2 m (6-90 GHz) and 0.7 m (> 90GHz)

Central frequency (GHz)	Bandwidth (MHz)	Polarisations	Accuracy (NE Δ T)	IFOV	Pixel
6.625	350	V, H K	34 x 56 km	40 x 12.5 km
10.65	100	V, H, R, L K	21 x 35 km	20 x 12.5 km
18.7	200	V, H, P, M, L, R K	12 x 20 km	10 x 12.5 km
23.8	400	V, H K	9.5 x 17 km	10 x 12.5 km
36.5	1000	V, H, P, M K	6.2 x 10 km	5 x 12.5 km

50.3	134	V K	4.5 x 7.5 km	5 x 12.5 km
52.240	1280	V K	4.5 x 7.5 km	5 x 12.5 km
53.570	960	V K	4.5 x 7.5 km	5 x 12.5 km
54.380	440	V K	4.5 x 7.5 km	5 x 12.5 km
54.905	350	V K	4.5 x 7.5 km	5 x 12.5 km
55.490	340	V K	4.5 x 7.5 km	5 x 12.5 km
56.660	300	V K	4.5 x 7.5 km	5 x 12.5 km
59.380	280	V K	4.5 x 7.5 km	5 x 12.5 km
59.940	440	V K	4.5 x 7.5 km	5 x 12.5 km
60.3712	57.6	L K	4.5 x 7.5 km	5 x 12.5 km
60.4080	16	L K	4.5 x 7.5 km	5 x 12.5 km
60.4202	8.4	L K	4.5 x 7.5 km	5 x 12.5 km
60.5088	44.8	L K	4.5 x 7.5 km	5 x 12.5 km
60.43476 (**)	20 (40 FFT channels)	H K	4.5 x 7.5 km	5 x 12.5 km
89.0	4000	V, H K	2.5 x 4.2	2.5 x 6.25 km
166 ± 0.7875	1425	V K	15 x 25	10 x 12.5 km
183.31 ± 7.70	4500	V K	15 x 25	10 x 12.5 km
183.31 ± 3.10	3500	V K	15 x 25	10 x 12.5 km
183.31 ± 0.7125	1275	V K	15 x 25	10 x 12.5 km
(*) Polarisation: H = horizontal, V = vertical, P = + 45°, M = - 45°, L = left-hand circular, R = right-hand circular					
(**) 20 MHz band centred on 60.43476 GHz (7+ line of O ₂) split in 40 channels by Fast Fourier Transform (FFT)					

CrIS	Cross-track Infrared Sounder
Satellites	NPP, NPOESS 1 to 6
Status (Sept 2005)	Close to launch – To be utilised in the period: 2006 to ~ 2026
Mission	Temperature/humidity sounding, ozone profile and total-column green-house gases
Instrument type	IR spectrometer/interferometer (1302 channels)
Scanning technique	Cross-track: 32 steps of 48 km ssp, swath 2200 km - Along-track: one 48-km line each 8 s
Coverage/cycle	Near-global coverage twice/day
Resolution (s.s.p.)	3 x 3 14 km IFOV covering a 48 x 48 km ² cell (average sampling distance: 16 km)

Spectral range (μm)	Spectral range (cm^{-1})	Spectral resolution (unapodised)	Radiometric accuracy (NE Δ T)
9.13 - 15.40 μm	650 - 1095 cm^{-1}	0.625 cm^{-1} K @ K
5.71 - 8.26 μm	1210 - 1750 cm^{-1}	1.25 cm^{-1} K @ K
3.92 - 4.64 μm	2155 - 2550 cm^{-1}	2.5 cm^{-1} K @ K

ERBS	Earth Radiation Budget Sensor
Satellites	NPOESS 2 and 5
Status (Sept 2005)	Definition being consolidated – To be utilised in the period 2011 to ~ 2025
Mission	Earth radiation budget
Instrument type	Two broad-band and one narrow-band channel radiometer
Scanning technique	Cross-track: 80 steps of 20 km ssp, swath 3000 km - Along-track: one 20-km line each 3 s
Coverage/cycle	Global coverage twice/day (IR and total radiance) or once/day (short-wave)
Resolution (s.s.p.)	20 km

Channel	Spectral interval	Noise Equivalent Radiance	Absolute accuracy	SNR
Narrow-band	8 - 12 μm $\text{Wm}^{-2}\text{sr}^{-1}$ $\text{Wm}^{-2}\text{sr}^{-1}$
Short-wave	0.3 - 5.0 μm $\text{Wm}^{-2}\text{sr}^{-1}$ $\text{Wm}^{-2}\text{sr}^{-1}$
Total radiance	0.3 - 100 μm $\text{Wm}^{-2}\text{sr}^{-1}$ $\text{Wm}^{-2}\text{sr}^{-1}$

GERB	Geostationary Earth Radiation Budget
Satellites	Meteosat 8 to 11 (Meteosat Second Generation)
Status (Sept 2005)	Operational – Utilisation period: 2002 to ~ 2018
Mission	Earth radiation budget
Instrument type	Two broad-band channels radiometer
Coverage/cycle	Full disk each 5 min. Integration over three cycles (15 min) to comply with accuracy requirements
Resolution (s.s.p.)	42 km

Channel	Spectral interval	Noise Equivalent Radiance	Absolute accuracy	SNR
Short-wave	0.32 - 4.0 μm	0.8 $\text{Wm}^{-2}\text{sr}^{-1}$	2.4 $\text{Wm}^{-2}\text{sr}^{-1}$	1250
Total radiance	0.32 - 30 μm	0.15 $\text{Wm}^{-2}\text{sr}^{-1}$	0.4 $\text{Wm}^{-2}\text{sr}^{-1}$	400

GLM	Geostationary Lightning Mapper
Satellites	GOES-R and follow-on
Status (Sept 2005)	Proposed – To be utilised from 2012 onward

Mission	Proxy for convective precipitation, proxy for NO _x generation, study of Earth electric field
Instrument type	CCD camera operating at 777.4 nm (O ₂) to count flashes and measure their intensity
Coverage/cycle	Large fraction of the disk continuously observed (time resolution 2 ms)
Resolution (s.s.p.)	8 km

GOME-2	Global Ozone Monitoring Experiment - 2
Satellites	Metop 1 to 3
Status (Sept 2005)	Close to launch – To be utilised in the period 2006 to ~ 2020
Mission	Ozone profile and total-column or gross profile of other species. Tracked species: BrO, ClO, H ₂ O, HCHO, NO, NO ₂ , NO ₃ , O ₂ , O ₃ , O ₄ , OCIO, SO ₂ and aerosol
Instrument type	UV/VIS grating spectrometer, four bands, 4096 channels, with 200 polarisation channels
Scanning technique	Cross-track: 24 steps of 40 km or 80 km ssp, swath 960 or 1920 km - Along-track: one 40-km line each 6 s
Coverage/cycle	Global coverage each 3 days with high resolution or 1.5 days with low resolution. Daylight only
Resolution (s.s.p.)	40 x 40 km ² associated to 960 km swath or 40 x 80 km ² associated to 1920 km swath

Spectral range	Number of channels	Spectral resolution	SNR at specified input radiance
240 - 315 nm	1024	0.24 - 0.29 nm	7-177 @ 50 % albedo and 60° Solar Zenith Angle
311 - 403 nm	1024	0.26 - 0.28 nm	372-3000 @ 50 % albedo and 60° SZA
401 - 600 nm	1024	0.44 - 0.53 nm	4000 @ 50 % albedo and 60° SZA
590 - 790 nm	1024	0.44 - 0.53 nm	2000-4000 @ 50 % albedo and 60° SZA
312 - 790 nm	200	2.8 nm at 312 nm to 40 nm at 790 nm	100 for $\lambda < 400$ nm, 1000 for $400 \text{ nm} < \lambda < 790$ nm

GPSOS	Global Positioning System Occultation Sensor
Satellites	NPOESS 2 and 5
Status (Sept 2005)	Design being consolidated – To be utilised in the period 2011 to ~ 2025
Mission	Temperature/humidity sounding with highest vertical resolution, space weather
Instrument type	GPS receiver measuring the phase delay due to refraction during occultation between GPS and LEO
Scanning technique	Limb scanning from 830 km to close-to-surface by time sampling – Azimuth 90° fore- and aft-
Coverage/cycle	About 500 soundings/day – Average spacing 1000 km – Global coverage (300 km spacing) in 10 days
Resolution	About 300 km

GRAS	GNSS Receiver for Atmospheric Sounding
Satellites	Metop 1 to 3
Status (Sept 2005)	Close to launch – To be utilised in the period 2006 to ~ 2020
Mission	Temperature/humidity sounding with highest vertical resolution, space weather
Instrument type	GPS receiver measuring the phase delay due to refraction during occultation between GPS and LEO
Scanning technique	Limb scanning from 830 km to close-to-surface by time sampling – Azimuth: 90° sectors fore- and aft-
Coverage/cycle	About 500 soundings/day – Average spacing 1000 km – Global coverage (300 km spacing) in 10 days
Resolution	About 300 km horizontal, 0.5 km vertical

HES	Hyperspectral Environmental Suite
Satellites	GOES-R (to become GOES-16) and follow-on
Status (Sept 2005)	Being defined – To be utilised from 2012 onward
Mission	Temperature/humidity sounding and wind profile derivation by tracking water vapour features
Instrument type	IR spectrometer (+ one VIS channel) for sounding, 14-19 channel radiometer for coastal waters
Coverage/cycle	Full disk in maximum 60 min. Limited areas in correspondingly shorter time intervals
Resolution (s.s.p.)	2-10 km for sounding (0.5-1.0 km for the VIS channel), 0.15-2.0 km for coastal waters

Spectral range (μm)	Spectral range (cm^{-1})	Spectral resolution (goal and threshold)	Accuracy (variation in the range)
15.0 - 15.4 μm	650 - 665 cm^{-1}	0.5 - 0.625 cm^{-1}	0.30 - 1.00 K @ 250 K
13.9 - 15.0 μm	665 - 720 cm^{-1}	0.5 - 0.625 cm^{-1}	0.17 - 0.30 K @ 250 K
13.0 - 13.9 μm	720 - 770 cm^{-1}	0.5 - 0.625 cm^{-1}	0.15 - 0.17 K @ 250 K
9.84 - 13.0 μm	770 - 1016 cm^{-1}	0.5 - 0.625 cm^{-1}	0.15 - 0.20 K @ 250 K
9.56 - 9.84 μm	1016 - 1046 cm^{-1}	0.5 - 0.625 cm^{-1}	0.15 - 0.20 K @ 250 K
8.33 - 9.56 μm	1046 - 1200 cm^{-1}	0.5 - 0.625 cm^{-1}	0.20 - 0.90 K @ 250 K
5.75 - 8.26 μm or	1210 - 1740 cm^{-1} or	0.625 - 1.25 cm^{-1}	0.13 - 0.24 K @ 250 K
4.65 - 6.06 μm	1650 - 2150 cm^{-1}	0.625 - 1.25 cm^{-1}	0.60 - 1.60 K @ 250 K
4.44 - 4.65 μm	2150 - 2250 cm^{-1}	2.5 cm^{-1}	1.5 - 2.0 K @ 250 K
3.68 - 4.44 μm (goal)	2250 - 2720 cm^{-1}	2.5 cm^{-1}	0.4 - 3.0 K @ 250 K
0.52 - 0.70 μm	N/A	0.18 μm	300 @ 100 % albedo

		Central wavelength	Bandwidth	SNR at specified input radiance
			0.412 μm	0.02 μm
		0.443 μm	0.02 μm	300 (threshold) to 600 (goal)
		0.477 μm	0.02 μm	300 (threshold) to 600 (goal)
		0.490 μm	0.02 μm	300 (threshold) to 600 (goal)
		0.510 μm	0.02 μm	300 (threshold) to 600 (goal)
		0.530 μm	0.02 μm	300 (threshold) to 600 (goal)
		0.550 μm	0.02 μm	300 (threshold) to 600 (goal)
		0.645 μm	0.02 μm	300 (threshold) to 600 (goal)
		0.667 μm	0.02 μm	300 (threshold) to 600 (goal)
		0.678 μm	0.02 μm	300 (threshold) to 600 (goal)
		0.750 μm	0.02 μm	300 (threshold) to 600 (goal)
		0.763 μm	0.02 μm	300 (threshold) to 600 (goal)
		0.865 μm	0.04 μm	300 (threshold) to 600 (goal)
		0.905 μm	0.02 μm	300 (threshold) to 600 (goal)

Channel designed for coastal water monitoring

Baseline channels for ocean colour
Resolution 150 - 300 m

	Goal channels	Cloud detection Resolution 0.9 - 1.2 km	1.38 μm	0.03 μm	300 (threshold) to 600 (goal)
			1.61 μm	0.06 μm	300 (threshold) to 600 (goal)
			2.26 μm	0.05 μm	300 (threshold) to 600 (goal)
		Sea surface temperature Resolution 1.0 - 2.0 km	11.2 μm	0.8 μm	$NE\Delta T = 0.1 \text{ K @ } 250 \text{ K}$
			12.3 μm	1.0 μm	$NE\Delta T = 0.1 \text{ K @ } 250 \text{ K}$

HIRS 3/4	High-resolution Infra Red Sounder 3 / 4
Satellites	TIROS-N, NOAA 6 to 19 - Metop 1 and 2
Status (Sept 2005)	Operational – Utilisation period: 1978 to ~ 2012 on NOAA, 2006 to ~ 2020 on Metop
Mission	Temperature/humidity sounding
Instrument type	20-channel IR radiometer (including one VIS)
Scanning technique	Cross-track: 56 steps of 26 km ssp, swath 2250 km - Along-track: one line each 42 km each 6.4 s
Coverage/cycle	Near-global coverage twice/day
Resolution (s.s.p.)	18 km for HIRS/3, 10 km IFOV for HIRS/4

Wavelength	Wavenumber	Bandwidth	Radiometric accuracy (NE Δ T or SNR)
14.95 μm	669 cm^{-1}	3 cm^{-1} K @ K
14.71 μm	680 cm^{-1}	10 cm^{-1} K @ K
14.49 μm	690 cm^{-1}	12 cm^{-1} K @ K
14.22 μm	703 cm^{-1}	16 cm^{-1} K @ K
13.97 μm	716 cm^{-1}	16 cm^{-1} K @ K
13.64 μm	733 cm^{-1}	16 cm^{-1} K @ K
13.35 μm	749 cm^{-1}	16 cm^{-1} K @ K
12.47 μm	802 cm^{-1}	16 cm^{-1} K @ K
11.11 μm	900 cm^{-1}	35 cm^{-1} K @ K
9.71 μm	1030 cm^{-1}	25 cm^{-1} K @ K
7.33 μm	1364 cm^{-1}	40 cm^{-1} K @ K
6.52 μm	1534 cm^{-1}	55 cm^{-1} K @ K
4.57 μm	2188 cm^{-1}	23 cm^{-1} K @ K
4.52 μm	2210 cm^{-1}	23 cm^{-1} K @ K
4.47 μm	2237 cm^{-1}	23 cm^{-1} K @ K
4.45 μm	2247 cm^{-1}	23 cm^{-1} K @ K
4.13 μm	2420 cm^{-1}	28 cm^{-1} K @ K
4.00 μm	2500 cm^{-1}	35 cm^{-1} K @ K
3.76 μm	2660 cm^{-1}	100 cm^{-1} K @ K
0.69 μm	N/A	0.05 μm @ ... % albedo

IASI	Infrared Atmospheric Sounding Interferometer
Satellites	Metop 1 to 3
Status (Sept 2005)	Close to launch – To be utilised in the period 2006 to ~ 2020
Mission	Temperature/humidity sounding, ozone profile and total-column green-house gases
Instrument type	IR spectrometer/interferometer (8460 channels) with one embedded IR imaging channel
Scanning technique	Cross-track: 60 steps of 24 km ssp, swath 2130 km - Along-track: one 48-km line each 8 s
Coverage/cycle	Near-global coverage twice/day
Resolution (s.s.p.)	4 x 12-km IFOV close to the centre of a 48 x 48 km^2 cell (average sampling distance: 24 km)

Spectral range (μm)	Spectral range (cm^{-1})	Spectral resolution (unapodised)	Accuracy (for 0.5 cm^{-1} channels) (NE Δ T)
8.26 - 15.50 μm	645 - 1210 cm^{-1}	0.25 cm^{-1}	0.2-0.3 K @ 280 K
5.00 - 8.26 μm	1210 - 2000 cm^{-1}	0.25 cm^{-1}	0.2-0.5 K @ 280 K
3.62 - 5.00 μm	2000 - 2760 cm^{-1}	0.25 cm^{-1}	0.5-2.0 K @ 280 K
10.3-12.5 μm	N/A	N/A	0.8 K @ 280 K

IMAGER	GOES Imager
Satellites	GOES 8 to 15
Status (Sept 2005)	Operational – Utilisation period: 1994 to ~ 2015
Mission	Multi-purpose VIS/IR imagery and wind derivation by tracking clouds and water vapour features
Instrument type	5-channel VIS/IR radiometer
Coverage/cycle	Full disk each 30 min. Limited areas in correspondingly shorter time intervals
Resolution (s.s.p.)	4.0 km for IR channels; 1.0 km for the VIS channel

Central wavelength	Spectral interval	Radiometric accuracy (NE Δ T or SNR)
0.65 μm	0.55 - 0.75 μm @ ... % albedo

3.90 μm	3.80 - 4.00 μm	0.11 K @ 300 K
6.55 μm	5.80 - 7.30 μm	0.14 K @ 300 K
10.70 μm	10.2 - 11.2 μm	0.09 K @ 300 K
13.35 μm	13.0 - 13.7 μm K @ 300 K

IMAGER	INSAT Imager
Satellites	INSAT-3D
Status (Sept 2005)	Being built – To be utilised in the period 2007 to ~ 2014
Mission	Multi-purpose VIS/IR imagery and wind derivation by tracking clouds and water vapour features
Instrument type	6-channel VIS/IR radiometer
Coverage/cycle	Full disk each 30 min. Limited areas in correspondingly shorter time intervals
Resolution (s.s.p.)	4.0 km for IR window channels; 1.0 km for VIS/SWIR channels; 8.0 km for water-vapour channel

Central wavelength	Spectral interval	Radiometric accuracy (NE Δ T or SNR)
0.65 μm	0.52 - 0.72 μm	150 @ 1 % albedo
1.625 μm	1.55 – 1.70 μm	150 @ 1 % albedo
3.90 μm	3.80 - 4.00 μm	1.4 K @ 300 K
6.8 μm	6.50 - 7.10 μm	1.0 K @ 230 K
10.8 μm	10.2 - 11.2 μm	0.35 K @ 300 K
12.0 μm	11.5 – 12.5 μm	0.35 K @ 300 K

IRAS	Infra Red Atmospheric Sounder
Satellites	FY-3 A to G
Status (Sept 2005)	Close to launch – To be utilised in the period 2006 to ~ 2021
Mission	Temperature/humidity sounding
Instrument type	26-channel IR radiometer (including one VIS)
Scanning technique	Cross-track: 56 steps of 26 km ssp, swath 2250 km - Along-track: one line each 42 km each 6.4 s
Coverage/cycle	Near-global coverage twice/day
Resolution (s.s.p.)	17 km IFOV

Wavelength	Wavenumber	Bandwidth	Radiometric accuracy (NE Δ T or SNR)
14.95 μm	669 cm^{-1}	3 cm^{-1} K @ K
14.80 μm	676 cm^{-1}	3 cm^{-1} K @ K
14.71 μm	680 cm^{-1}	10 cm^{-1} K @ K
14.49 μm	690 cm^{-1}	12 cm^{-1} K @ K
14.22 μm	703 cm^{-1}	16 cm^{-1} K @ K
13.97 μm	716 cm^{-1}	16 cm^{-1} K @ K
13.64 μm	733 cm^{-1}	16 cm^{-1} K @ K
13.35 μm	749 cm^{-1}	16 cm^{-1} K @ K
11.11 μm	900 cm^{-1}	35 cm^{-1} K @ K
9.71 μm	1030 cm^{-1}	25 cm^{-1} K @ K
8.16 μm	1225 cm^{-1}	25 cm^{-1} K @ K
7.33 μm	1364 cm^{-1}	40 cm^{-1} K @ K
6.52 μm	1534 cm^{-1}	80 cm^{-1} K @ K
4.57 μm	2188 cm^{-1}	23 cm^{-1} K @ K
4.52 μm	2210 cm^{-1}	23 cm^{-1} K @ K
4.47 μm	2237 cm^{-1}	23 cm^{-1} K @ K
4.40 μm	2273 cm^{-1}	23 cm^{-1} K @ K
4.20 μm	2381 cm^{-1}	23 cm^{-1} K @ K

4.00 μm	2500 cm^{-1}	35 cm^{-1} K @ K
3.76 μm	2660 cm^{-1}	100 cm^{-1} K @ K
1.64 μm	N/A	TBD @ % albedo
1.24 μm	N/A	TBD @ % albedo
0.94 μm	N/A	TBD @ % albedo
0.885 μm	N/A	TBD @ % albedo
0.69 μm	N/A	0.05 μm @ % albedo
0.659 μm	N/A	TBD @ % albedo

IRFS-2	Infrared Sounding Spectrometer
Satellites	Meteor-M-2
Status (Sept 2005)	Being built – To be utilised in the period 2008 to ~ 2012
Mission	Temperature/humidity sounding, ozone profile and total-column green-house gases
Instrument type	IR spectrometer/interferometer, 4000 channels
Scanning technique	Cross-track: 30 steps to cover a swath of 1000 km if contiguous, up to 2500 km with gaps
Coverage/cycle	Near-global coverage twice/day (with gaps) or once/day (continuous)
Resolution (s.s.p.)	35 km IFOV

Spectral range (μm)	Spectral range (cm^{-1})	Spectral resolution (unapodised)	Radiometric accuracy (NE Δ T)
5 – 15 μm	667 – 2000 cm^{-1}	0.5 cm^{-1}	0.5 K @ 300 K

JAMI IMAGER	Japanese Advanced Meteorological Imager
Satellites	MTSAT- 1R (JAMI) and MTSAT-2 (IMAGER)
Status (Sept 2005)	Operational - Utilisation period: 2005 to 2015
Mission	Multi-purpose VIS/IR imagery and wind derivation by tracking clouds and water vapour features
Instrument type	5-channel VIS/IR radiometer
Coverage/cycle	Full disk each 30 min; half disk each 15 min
Resolution (s.s.p.)	IFOV: 4.0 km for IR channels; 1.0 km for the VIS channel

Central wavelength	Spectral interval	Radiometric accuracy (NE Δ T or SNR)
0.72 μm	0.55 - 0.90 μm	6.5 @ 2.5 % albedo
3.75 μm	3.50 - 4.00 μm	0.09 K @ 300 K
6.75 μm	6.50 - 7.00 μm	0.12 K @ 300 K
10.8 μm	10.3 - 11.3 μm	0.11 K @ 300 K
12.0 μm	11.5 - 12.5 μm	0.20 K @ 300 K

Klimat	Infrared Imaging Radiometer
Satellites	Meteor-3M
Status (Sept 2005)	Operational – Utilised in the period: 2001 to ~ 2004
Mission	Cloud imagery
Instrument type	1-channel IR radiometer
Scanning technique	Cross-track, swath 3100 km – Along-track: two 3-km lines/s
Coverage/cycle	Global coverage twice/day
Resolution (s.s.p.)	3.0 km IFOV

Central wavelength	Spectral interval	Radiometric accuracy (NE Δ T)
11.5 μm	10.5 – 12.5 μm	0.5 K @ 300 K

KMSS	High-resolution VIS/IR Radiometer
Satellites	Meteor-3M₁ and N3
Status (Sept 2005)	Operational – Utilisation period: 2001 to ~ 2005
Mission	High-resolution imagery
Instrument type	3-channel VIS/NIR radiometer
Scanning technique	Cross-track: 2048-1210 CCD/line-of-800-m ssp; swath 3000-46 km with pointing capability within 430 km

Coverage/cycle	Duty cycle 10 %; to be operated with strategic pointing
Resolution (s.s.p.)	38 m IFOV

Central wavelength	Spectral interval	Radiometric accuracy (SNR)
0.555 μm	0.535 - 0.575 μm	-200 @ 100 % albedo
0.655 μm	0.63 - 0.68 μm	200 @ 100 % albedo
0.655 μm	0.63 - 0.68 μm	200 @ 100 % albedo
0.655 μm	0.63 - 0.68 μm	200 @ 100 % albedo
0.655 μm	0.63 - 0.68 μm	200 @ 100 % albedo
0.845 μm	0.79 - 0.90 μm	200 @ 100 % albedo

MERSI	Medium Resolution Spectral Imager
Satellites	FY-3 A to G
Status (Sept 2005)	Close to launch – To be utilised in the period: 2006 to ~ 2021
Mission	Vegetation indexes and ocean colour
Instrument type	20-channel radiometer, 19 narrow-bandwidth in VIR/NIR/SWIR and one broadband in the Thermal IR
Scanning technique	Cross-track: pixel of km ssp, swath km - Along-track: -km lines/s
Coverage/cycle	Global coverage in days (in daylight)
Resolution (s.s.p.)	250 m for broad-band channels, 1.0 km for narrow-band channels

Channel set	Central wavelength	Spectral range or Bandwidth	Radiometric accuracy (NE Δ T or SNR)
Broad-band channels with 250 m resolution, mostly for clouds, vegetation and surface temperature	0.470 μm	0.445 - 0.495 μm @ % albedo
	0.550 μm	0.525 - 0.575 μm @ % albedo
	0.650 μm	0.625 - 0.675 μm @ % albedo
	0.865 μm	0.840 - 0.890 μm @ % albedo
	11.250 μm	10.0 - 12.5 μm K @ 300 K
Narrow-band channels with 1000 m resolution, for ocean colour, vegetation, aerosol	412 nm	20 nm @ % albedo
	443 nm	20 nm @ % albedo
	490 nm	20 nm @ % albedo
	520 nm	20 nm @ % albedo
	565 nm	20 nm @ % albedo
	650 nm	20 nm @ % albedo
	685 nm	20 nm @ % albedo
	765 nm	20 nm @ % albedo
	865 nm	20 nm @ % albedo
	905 nm	20 nm @ % albedo
	940 nm	20 nm @ % albedo
	980 nm	20 nm @ % albedo
	1030 nm	20 nm @ % albedo
1640 nm	50 nm @ % albedo	
2130 nm	50 nm @ % albedo	

MHS	Microwave Humidity Sounder Unit
Satellites	NOAA 18 to 19 - Metop 1 to 3
Status (Sept 2005)	Operational - Utilisation period: 2005 to ~ 2012 on NOAA, 2006 to ~ 2020 on Metop
Mission	Humidity sounding in almost all-weather conditions. Also precipitation rate
Instrument type	5-channel MW radiometer
Scanning technique	Cross-track: 90 steps of 16 km ssp, swath 2170 km - Along-track: one 16-km line each 8/3 s
Coverage/cycle	Near-global coverage twice/day
Resolution (s.s.p.)	16 km IFOV

Central frequency (GHz)	Bandwidth (MHz)	Polarisation	Radiometric accuracy (NE Δ T)
-------------------------	-----------------	--------------	--------------------------------------

89.0	2800	V	1.0 K
157.0	2800	V	1.0 K
183.31 ± 3.0	2000	H	1.0 K
183.31 ± 1.0	1000	H	1.0 K
190.311	2200	V	1.0 K

MI	Meteorological Imager
Satellites	COMS 1 and 2
Status (Sept 2005)	Being designed – To be utilised in the period 2008 to ~ 2021
Mission	Multi-purpose VIS/IR imagery and wind derivation by tracking clouds and water vapour features
Instrument type	10-channel VIS/IR radiometer
Coverage/cycle	Full disk in 25 min. Limited areas in correspondingly shorter time intervals
Resolution (s.s.p.)	1 km IFOV in 3 VNIR channels, 7 km IFOV in 7 IR channels

Central wavelength	Spectral interval	Radiometric accuracy (NEAT or SNR)
0.6 μm - μm @ % albedo
0.8 μm - μm @ % albedo
1.6 μm - μm @ % albedo
3.8 μm - μm K @ 300 K
6.2 μm - μm K @ K
7.2 μm - μm K @ K
7.9 μm - μm K @ K
11 μm - μm K @ 300 K
12 μm - μm K @ 300 K
13.7 μm - μm K @ K

MR-2000M1	Television Camera
Satellites	Meteor-3M
Status (Sept 2005)	Operational – Utilised in the period: 2001 to ~ 2005
Mission	Cloud imagery
Instrument type	1-channel television camera
Scanning technique	Cross-track swath 3100 km – Along-track: 4 lines/s
Coverage/cycle	Global coverage once/day (in daylight)
Resolution (s.s.p.)	1.5 km IFOV

Central wavelength	Spectral interval	Radiometric accuracy (SNR)
0.65 μm	0.50 - 0.80 μm	250 @ 100 % albedo

MSU-E	VIS/IR Imaging Radiometer
Satellites	Meteor-3M₁ and N3
Status (Sept 2005)	Operational – Utilisation period: 2001 to ~ 2005
Mission	High-resolution imagery
Instrument type	3-channel VIS/NIR radiometer
Scanning technique	Cross-track: 2048 1210 CCD/ line-of 800-m ssp ; swath 3000 46 km with pointing capability within 430 km
Coverage/cycle	Duty cycle 10 %; to be operated with strategic pointing
Resolution (s.s.p.)	38 m IFOV

Central wavelength	Spectral interval	Radiometric accuracy (SNR)
0.555 μm	0.535 - 0.575 μm	-200 @ 100 % albedo
0.655 μm	0.63 – 0.68 μm	200 @ 100 % albedo
0.845 μm	0.79 – 0.90 μm	200 @ 100 % albedo

MSU-GS	Elektro-GOMS Imager
Satellites	Elektro-L and follow on
Status (Sept 2005)	Planned - To be utilised from 2006 onward
Mission	Multi-purpose VIS/IR imagery and wind derivation by tracking clouds and water vapour features
Instrument type	10-channel VIS/IR radiometer
Coverage/cycle	Full disk each 15-30 min.
Resolution (s.s.p.)	4.0 km for the IR channels, 1.0 km for the VNIR channels

Central wavelength	Spectral interval	Radiometric accuracy (SNR or NE Δ T)
0.57 μ m	0.50 - 0.65 μ m	200 @ 100 % albedo
0.72 μ m	0.65 - 0.80 μ m	200 @ 100 % albedo
0.86 μ m	0.80 - 0.90 μ m	200 @ 100 % albedo
3.75 μ m	3.50 - 4.00 μ m	0.35 K @ 300 K
6.35 μ m	5.70 - 7.00 μ m	0.4 K @ 300 K
8.00 μ m	7.50 - 8.50 μ m	0.1 K @ 300 K
8.70 μ m	8.20 - 9.20 μ m	0.15 K @ 300 K
9.70 μ m	9.20 - 10.2 μ m	0.15 K @ 300 K
10.7 μ m	10.2 - 11.2 μ m	0.15 K @ 300 K
11.7 μ m	11.2 - 12.5 μ m	0.25 K @ 300 K

MSU-MR	VIS/IR Imaging Radiometer	
Satellites	Meteor-3M-1/2 and N3	
Status (Sept 2005)	Close to launch – To be utilised in the period 2005 to ~ 2012/2013	
Mission	Multi-purpose VIS/IR imagery	
Instrument type	6-channel VIS/IR radiometer	
Scanning technique	Cross-track: 2048-1540 pixels in line-of-800-m-ssp, swath 3000-2800 km - Along-track: six 4.1-km lines/s	
Coverage/cycle	Global coverage twice/day (IR) or once/day (VIS)	
Resolution (s.s.p.)	1.0 km IFOV	
Central wavelength	Spectral interval	Radiometric accuracy (SNR or NE Δ T)
0.60 μ m	0.50 - 0.70 μ m	1000 @ 80 % albedo
0.95 μ m	0.80 - 1.10 μ m	1000 @ 80 % albedo
1.70 μ m	1.60 - 1.80 μ m	1000 @ 80 % albedo
3.80 μ m	3.50 - 4.10 μ m0.5 K @ 300 K
11.00 μ m	10.5 - 11.5 μ m0.5 K @ 300 K
12.00 μ m	11.5 - 12.5 μ m	0......5 K @ 300 K

MTG imager(s)	Name(s) to be defined
Satellites	Meteosat-12 and follow-on (Meteosat Third Generation)
Status (Sept 2005)	Being defined - To be utilised from 2015 onward
Mission	Multi-purpose VIS/IR imagery and wind derivation by tracking clouds and water vapour features
Instrument type	Imager-1: ~ 5-channel VIS/IR radiometer; Imager-2: ~ 15-channel VIS/IR radiometer
Coverage/cycle	Imager-1: 1/3 of the disk in 2-5 min; Imager-2: full disk in 5-10 min
Resolution	Imager-1: 0.5-1.0 km; Imager-2: 1.0-3.0 km

(s.s.p.)	
----------	--

Imager-1			Imager-2		
Central wavelength	Bandwidth	SNR or NE Δ T	Central wavelength	Bandwidth	SNR or NE Δ T
			0.470 μ m	0.02 μ m	30 @ 1 % albedo
0.60 μ m	0.20 μ m	10 @ 1 % albedo	0.645 μ m	0.05 μ m	30 @ 1 % albedo
			0.865 μ m	0.04 μ m	30 @ 1 % albedo
			1.375 μ m	0.03 μ m	40 @ 1 % albedo
			1.61 μ m	0.06 μ m	40 @ 1 % albedo
2.10 μ m	0.20 μ m	10 @ 1 % albedo	2.26 μ m	0.05 μ m	30 @ 1 % albedo
3.80 μ m	0.60 μ m	0.2 K @ 300 K	3.75 μ m	0.30 μ m	0.1 K @ 300 K
			6.70 μ m	0.40 μ m	0.3 K @ 250 K
7.3 μ m	0.70 μ m	0.5 K @ 250 K	7.35 μ m	0.30 μ m	0.3 K @ 250 K
			8.55 μ m	0.30 μ m	0.1 K @ 300 K
			9.70 μ m	0.30 μ m	0.3 K @ 250 K
10.8 μ m	2.20 μ m	0.2 K @ 300 K	10.8 μ m	0.5 μ m	0.1 K @ 300 K
			12.0 μ m	0.7 μ m	0.1 K @ 300 K
			13.08 μ m	0.4 μ m	0.2 K @ 270 K
			13.91 μ m	0.4 μ m	0.2 K @ 250 K

Option 1 for Imager-2 (A-band of O ₂) for improved cloud-top height	λ [nm]	$\Delta\lambda$ [nm]	SNR
	755	5	150 @ 100 Wm ⁻² sr ⁻¹ μ m ⁻¹
	761	3	150 @ 100 Wm ⁻² sr ⁻¹ μ m ⁻¹
	764	6	150 @ 100 Wm ⁻² sr ⁻¹ μ m ⁻¹
Option 2 for Imager-2 (spectrometer in the 5 μ m band) for temperature/humidity sounding in the lower troposphere	Spectral range	Spectral resolution	NEΔT
	4.33-5.49 μ m	$\Delta\nu = 2$ cm ⁻¹ (256 channels)	0.2 K @ 280 K
Option 3 for Imager-2 (slicing of the 14 μ m band) for improved cloud top height	λ [μ m]	$\Delta\lambda$ [μ m]	NE Δ T
	13.03	0.15	0.2 K @ 270 K
	13.33	0.15	0.2 K @ 250 K
	13.66	0.15	0.2 K @ 250 K
	14.07	0.15	0.2 K @ 250 K

MTG lightning mapper	Name to be defined
Satellites	Meteosat-12 and follow-on (Meteosat Third Generation)
Status (Sept 2005)	Being defined - To be utilised from 2015 onward
Mission	Proxy for convective precipitation, proxy for NO _x generation, study of Earth electric field
Instrument type	CCD camera operating at 777.4 nm (O ₂) to count flashes and measure their intensity
Coverage/cycle	Large fraction of the disk continuously observed (time resolution ~1 ms)
Resolution (s.s.p.)	5-10 km

MTG sounder	Name to be defined
Satellites	Meteosat-12 and follow-on (Meteosat Third Generation)
Status (Sept 2005)	Being defined - To be utilised from 2015 onward
Mission	Temperature/humidity sounding and wind profile derivation by tracking water vapour features
Instrument type	IR spectrometer/interferometer with large detector arrays for simultaneous sounding of more pixels
Coverage/cycle	Full disk in 15-30 min. Limited areas in correspondingly shorter time intervals
Resolution (s.s.p.)	3-6 km (at 5 μm), 6-12 km (at 14 μm)

Spectral range (μm)	Spectral range (cm^{-1})	Spectral resolution	Radiometric accuracy (NE Δ T)
14.3 - 15.0 μm	667 - 700 cm^{-1}	0.5 cm^{-1}	Not specified
13.0 - 14.3 μm	700 - 770 cm^{-1}	0.5 cm^{-1}	0.20 K @ 280 K
10.2 - 13.0 μm	770 - 980 cm^{-1}	0.625 cm^{-1}	0.24 K @ 280 K
9.34 - 10.2 μm	980 - 1070 cm^{-1}	0.5 cm^{-1}	0.20 K @ 280 K
8.26 - 9.34 μm	1070 - 1210 cm^{-1}	0.85 cm^{-1}	0.20 K @ 280 K
6.25 - 8.26 μm	1210 - 1600 cm^{-1}	0.625 cm^{-1}	0.20 K @ 280 K
5.00 - 6.25 μm	1600 - 2000 cm^{-1}	0.625 cm^{-1}	0.20 K @ 280 K
4.44 - 5.00 μm	2000 - 2250 cm^{-1}	0.625 cm^{-1}	0.30 K @ 280 K
4.17 - 4.44 μm	2250 - 2400 cm^{-1}	1.25 cm^{-1}	Not specified
4.00 - 4.17 μm	2400 - 2500 cm^{-1}	2.45 cm^{-1}	Not specified

MTVZA	Imaging/Sounding Microwave Radiometer
Satellites	Meteor-3M, Meteor-M 1/2 and N3
Status (Sept 2005-2005)	Operational Operational - Utilisation period: 2004-2001 to ~ 2009-2015
Mission	Multi-purpose MW imager with temperature/humidity sounding channels for improved precipitation
Instrument type	2021-frequency / ,2629-channel MW radiometer
Scanning technique	Conical: 6953,3° zenith angle, swath 2200-1500 km – Scan rate: 24.9 scan/min = 15.8 km/scan
Coverage/cycle	Near-global coverage twice/day
Resolution (constant)	From Changing with frequency, consistent with an antenna diameter of 10 km at 183 GHz to 200 km at 10.6 GHz; consistent with an antenna diameter of 65 x cm

Central frequency (GHz)	Bandwidth (MHz)	Polarisations	Accuracy (NE Δ T)	IFOV	Pixel
10.6	100	V, H	0.5 K	89x198 km	32x32 km
18.7	800-200	V, H	0.25-0.4 K	52x160 km 75 x 136 km	32x32-35.6 x 31.6 km
22-23-25-23.8	1600-400	V, H	0.25-0.3 K	68 x 1244-2x94 km	35.6 x 31.6-32x32 km
33-0-31.5	2000-400	V, H	0..35 K	45 x 8235x76 km	35.6 x 31.6-32x32 km
36-5-36.7	2000-400	V, H	0..38 K	41 x 7530x67 km	35.6 x 31.6-32x32 km
42.0	2000-400	V, H	0..45 K	36 x 6526x60 km	35.6 x 31.6-32x32 km
48.0	2000-400	V, H	0..45 K	32 x 5824x43 km	35.6 x 31.6-32x32 km
52.80	400	V	0-30.4 K	30 x 5521x48 km	71.2 x 63.248x48 km
53.30	400	V	0-30.4 K	30 x 5521x48 km	71.2 x 63.248x48 km
53.80	400	V	0-30.4 K	30 x 5521x48 km	71.2 x 63.248x48 km
54.64	400	V	0-30.4 K	30 x 5521x48 km	71.2 x 63.248x48 km

					km
55.63	400	V	<u>0.30.4</u> K	<u>30-x</u> <u>5521x48</u> km	<u>71.2-x</u> <u>63.248x48</u> km
57.290344±0.3222±0.1	50	H	<u>0.30.4</u> K	<u>30-x</u> <u>5521x48</u> km	<u>71.2-x</u> <u>63.248x48</u> km
57.290344±0.3222±0.05	20	H	<u>0.30.7</u> K	<u>30-x</u> <u>5521x48</u> km	<u>71.2-x</u> <u>63.248x48</u> km
57.290344±0.3222±0.025	10	H	<u>0.9</u> K	<u>30-x</u> <u>5521x48</u> km	<u>71.2-x</u> <u>63.248x48</u> km
57.290344±0.3222±0.01	5	H	<u>0.31.3</u> K	<u>30-x</u> <u>5521x48</u> km	<u>71.2-x</u> <u>63.248x48</u> km
57.290344±0.3222±0.005	3	H	<u>1.7</u> K	<u>21x48</u> km	<u>48x48</u> km
<u>91.655</u>	<u>2500</u>	V, H	<u>0.6</u> K	<u>14x30</u> km	<u>16x16</u> km
183.31 ± 7.0	1500	V	<u>0.5</u> K	<u>9x21</u> km	<u>32x32</u> km
183.31 ± 3.0	1000	V	0.6 K	12-x <u>229x21</u> km	<u>32x32</u> km
183.31 ± 1.0	500	V	<u>0.8</u> K	<u>9x21</u> km	<u>32x32</u> km

MVIRI	Meteosat Visible Infra-Red Imager
Satellites	Meteosat 1 to 7
Status (Sept 2005)	Operational - Utilisation period: 1977 to ~ 2008
Mission	Multi-purpose VIS/IR imagery and wind derivation by tracking clouds and water vapour features
Instrument type	3-channel VIS/IR radiometer
Coverage/cycle	Full disk each 30 min. Limited areas in correspondingly shorter time intervals
Resolution (s.s.p.)	IFOV: 5.0 km for IR channels, 2.5 km for the VIS channel

Central wavelength	Spectral interval	Radiometric accuracy (SNR or NE Δ T)
0.70 μm	0.50 - 0.90 μm	3 @ 1 % albedo
6.40 μm	5.70 - 7.10 μm	1.0 K @ 250 K
11.5 μm	10.5 - 12.5 μm	0.5 K @ 300 K

MVISR	Multichannel Visible Infrared Scanning Radiometer
Satellites	FY-1 A to D
Status (Sept 2005)	Operational – Utilisation period: 1988 to ~ 2006
Mission	Multi-purpose VIS/IR imagery with emphasis on vegetation and ocean colour
Instrument type	10-channel VIS/IR radiometer
Scanning technique	Cross-track: 2048 pixel of 800 m ssp, swath 2800 km - Along-track: six 1.1-km lines/s
Coverage/cycle	Global coverage twice/day (IR) or once/day (VIS)
Resolution (s.s.p.)	1.1 km

Central wavelength	Spectral interval	Radiometric accuracy (SNR or NE Δ T)
0.455 μm	0.43 - 0.48 μm	3.0. @ 0.5 % albedo
0.505 μm	0.48 - 0.53 μm	3.0. @ 0.5 % albedo
0.555 μm	0.53 - 0.58 μm	3.0. @ 0.5 % albedo
0.630 μm	0.58 - 0.68 μm	3.0. @ 0.5 % albedo
0.865 μm	0.84 - 0.89 μm	3.0. @ 0.5 % albedo
0.932 μm	0.90 - 0.965 μm	3.0. @ 0.5 % albedo
1.600 μm	1.55 - 1.64 μm	3.0. @ 0.5 % albedo
3.740 μm	3.55 - 3.93 μm	0.40 K @ 300 K
10.80 μm	10.3 - 11.3 μm	0.22 K @ 300 K
12.00 μm	11.5 - 12.5 μm	0.22 K @ 300 K

MWHS	Micro-Wave Humidity Sounder
Satellites	FY-3 A to G
Status (Sept 2005)	Close to be launched – To be utilised in the period: 2006 to ~ 2021
Mission	Humidity sounding in nearly-all-weather conditions
Instrument type	4-frequency / 5-channel MW radiometer
Scanning technique	Cross-track: steps of km ssp, swath 2250 km - Along-track: one-km line each s
Coverage/cycle	Global coverage twice/day
Resolution (s.s.p.)	15 km IFOV

Central frequency (GHz)	Bandwidth (MHz)	Polarisations	Accuracy (NE Δ T)
150	2000	V, H	0.9 K
183.31 \pm 7.0	2000	0.9 K
183.31 \pm 3.0	1000	0.9 K

183.31 ± 1.0	500	1.1 K
--------------	-----	-------	-------

MWRI	Micro-Wave Radiation Imager
Satellites	FY-3 A to G
Status (Sept 2005)	Close to be launched – To be utilised in the period 2006 to ~ 2021
Mission	Multi-purpose MW imager
Instrument type	6-frequency, 12-channel MW radiometer
Scanning technique	Conical: 53.1° zenith angle, swath 1400 km – Scan rate: scan/min = km/scan
Coverage/cycle	Global coverage once/day
Resolution (constant)	Changing with frequency, consistent with an antenna diameter of x cm

Central frequency (GHz)	Bandwidth (MHz)	Polarisations	Accuracy (NEΔT)	IFOV	Pixel
~ 10	180	V, H K x km x km
~ 19	200	V, H K x km x km
~ 22	400	V, H K x km x km
~ 37	900	V, H K x km x km
~ 90	4600	V, H K x km x km
~150	3000	V, H K x km x km

OMPS	Ozone Mapping and Profiler Suite
Satellites	NPP, NPOESS 2 and 5
Status (Sept 2005)	Being built – Utilisation period: 2006 to ~ 2025
Mission	Ozone profile and total-column or gross profile of other species. Tracked species: BrO, HCHO, NO ₂ , O ₃ , OCIO, SO ₂
Instrument type	Three UV/VIS/NIR grating spectrometers for mapping, nadir profiling and limb sounding respectively
Scanning technique	Mapper: cross-track swath 2800 km, along-track one 50-km line in 7.6 s. Nadir profiler: one along-track sounding each 38 s (250 km). Limb sounder: 1-km vertical steps between 10 and 60 km
Coverage/cycle	Global coverage: mapper once/day, nadir profiler in 6 days, limb sounder in 4 days. Daylight only
Resolution (s.s.p.)	Mapper: 50 km. Nadir profiler: 250 km. Limb sounder: about 300 km

Subsystem	Spectral range	Spectral resolution	SNR at specified input radiance
Cross-track mapper for total ozone	300 - 380 nm	1 nm	1000
Nadir-viewing ozone profiler	250 - 310 nm	1 nm	35 (at 250 nm) to 400 (at 310 nm)
Limb scanning	290 - 1000 nm	1.5 to 40 nm	320 (at 290 nm) to 1200 (at 600 nm)

OS	Ocean Sensor
Satellites	COMS 1 and 2
Status (Sept 2005)	Being designed – To be utilised in the period 2008 to ~ 2021
Mission	Ocean colour and aerosol

Instrument type	8-channel VIS/NIR radiometer	
Scanning technique	Bushbroom, 6000 pixel/line (3700 useful), swath 1420 km	
Coverage/cycle	Area of 2500 km x 2500 km, hourly in daylight	
Resolution (s.s.p.)	500 m IFOV	
Central wavelength	Band width	Radiometric accuracy (SNR @ specified NEΔL)
412 nm	20 nm	1000 @ 0.100 W m ⁻² sr ⁻¹ μ ⁻¹
443 nm	20 nm	1090 @ 0.086 W m ⁻² sr ⁻¹ μ ⁻¹
490 nm	20 nm	1170 @ 0.067 W m ⁻² sr ⁻¹ μ ⁻¹
555 nm	20 nm	1070 @ 0.056 W m ⁻² sr ⁻¹ μ ⁻¹
625 nm	20 nm	1010 @ 0.032 W m ⁻² sr ⁻¹ μ ⁻¹
670 nm	20 nm	870 @ 0.031 W m ⁻² sr ⁻¹ μ ⁻¹
765 nm	40 nm	860 @ 0.020 W m ⁻² sr ⁻¹ μ ⁻¹
865 nm	40 nm	750 @ 0.016 W m ⁻² sr ⁻¹ μ ⁻¹

Radiomet	Radio-occultation sounder
Satellites	Meteor-M-2
Status (Sept 2005)	Being built – Utilisation period: 2008 to ~ 2012
Mission	Temperature/humidity sounding with highest vertical resolution, space weather
Instrument type	GPS receiver measuring the phase delay due to refraction during occultation between GPS and LEO
Scanning technique	Limb scanning from 830 km to close-to-surface by time sampling – Azimuth 90° fore-and aft-
Coverage/cycle	About 500 soundings/day – Average spacing 1000 km – Global coverage (300 km spacing) in 10 days
Resolution	300 km (horizontal), 0.5-1.0 km (vertical)

SAGE-III	Stratospheric Aerosol and Gas Experiment – III
Satellites	Meteor-3M
Status (Sept 2005)	Operational - Utilisation period: 2001 to ~ 2005
Mission	Atmospheric chemistry in the stratosphere. Species: H ₂ O, NO ₂ , NO ₃ , O ₃ , OClO and aerosol
Instrument type	UV/VIS/NIR/SWIR (290-1550 nm) 9-band solar and lunar occultation grating spectrometer
Scanning technique	Sun and moon tracking during the occultation phase, 1-km step from ~ 10 to ~ 85 km
Coverage/cycle	N/A (few tens of events/day limited to latitudes above ~ 60°)
Resolution	300 km (horizontal), 1-2 km (vertical)

SBUV/2	Solar Backscatter Ultraviolet / 2
Satellites	NOAA 9 to 19 except 12 and 15
Status (Sept 2005)	Operational – Utilisation period: 1984 to ~ 2012
Mission	Vertical profile of ozone and other species. Solar irradiance
Instrument type	UV spectro-radiometer. Either 12 discrete 1-nm bandwidth channels selectable in the interval 252 to 340 nm, or continuous sweep from 160 to 340 nm.
Scanning technique	Nadir view only
Coverage/cycle	About 1650 measurements/day. Global coverage (170 km spacing) in 10 days, in daylight
Resolution	170 km

Severjanin	Onboard Radar Complex
Satellites	Meteor-M 1 and 2
Status (Sept 2005)	Close to launch – To be utilised in the period 2006 to ~ 2013
Mission	High-resolution all-weather land observation
Instrument type	X-band SAR, frequency 9.623 GHz
Scanning technique	Side-looking 25-48°, swath 600 km
Coverage/cycle	Global coverage in 1 month (duty cycle 10-20 %)
Resolution	Two modes: 400-500 m or 700-1000 m

SEVIRI	Spinning Enhanced Visible Infra-Red Imager
Satellites	Meteosat 8 to 11 (Meteosat Second Generation)
Status (Sept 2005)	Operational - Utilisation period: 2002 to ~ 2018
Mission	Multi-purpose VIS/IR imagery and wind derivation by tracking clouds and water vapour features
Instrument type	12-channel VIS/IR radiometer (11 narrow-bandwidth, 1 high-resolution broad-bandwidth)

	VIS)
Coverage/cycle	Full disk each 15 min. Limited areas in correspondingly shorter time intervals
Resolution (s.s.p.)	4.8 km IFOV, 3 km sampling for narrow channels; 1.4 km IFOV, 1 km sampling for broad VIS channel

Central wavelength	Spectral interval (99 % encircled energy)	Radiometric accuracy (SNR or NEAT)
N/A (broad bandwidth channel)	0.6 – 0.9 μm	4.3 @ 1 % albedo
0.635 μm	0.56 – 0.71 μm	10.1 @ 1 % albedo
0.81 μm	0.74 – 0.88 μm	7.28 @ 1 % albedo
1.64 μm	1.50 – 1.78 μm	3 @ 1 % albedo
3.92 μm	3.48 – 4.36 μm	0.35 K @ 300 K
6.25 μm	5.35 – 7.15 μm	0.75 K @ 250 K
7.35 μm	6.85 – 7.85 μm	0.75 K @ 250 K
8.70 μm	8.30 – 9.10 μm	0.28 K @ 300 K
9.66 μm	9.38 – 9.94 μm	1.50 K @ 255 K
10.8 μm	9.80 - 11.8 μm	0.25 K @ 300 K
12.0 μm	11.0 - 13.0 μm	0.37 K @ 300 K
13.4 μm	12.4 - 14.4 μm	1.80 K @ 270 K

SOUNDER	GOES Sounder
Satellites	GOES 8 to 15
Status (Sept 2005)	Operational – Utilisation period: 1994 to ~ 2015
Mission	Temperature/humidity sounding
Instrument type	19-channel IR radiometer (including one VIS)
Coverage/cycle	Full disk in 8 h, 3000x3000 km ² in 42 min, 1000x1000 km ² in 5 min
Resolution (s.s.p.)	8.0 km

Wavelength	Wavenumber	Bandwidth	Radiometric accuracy (SNR or NEAT)
14.71 μm	680 cm ⁻¹	13 cm ⁻¹	1.24 K @ 290 K
14.37 μm	696 cm ⁻¹	13 cm ⁻¹	0.79 K @ 290 K
14.06 μm	711 cm ⁻¹	13 cm ⁻¹	0.68 K @ 290 K
13.64 μm	733 cm ⁻¹	16 cm ⁻¹	0.55 K @ 290 K
13.37 μm	748 cm ⁻¹	16 cm ⁻¹	0.49 K @ 290 K
12.66 μm	790 cm ⁻¹	30 cm ⁻¹	0.23 K @ 290 K
12.02 μm	832 cm ⁻¹	50 cm ⁻¹	0.14 K @ 290 K
11.03 μm	907 cm ⁻¹	50 cm ⁻¹	0.10 K @ 290 K
9.71 μm	1030 cm ⁻¹	25 cm ⁻¹	0.12 K @ 290 K
7.43 μm	1345 cm ⁻¹	55 cm ⁻¹	0.06 K @ 290 K
7.02 μm	1425 cm ⁻¹	80 cm ⁻¹	0.06 K @ 290 K
6.51 μm	1535 cm ⁻¹	60 cm ⁻¹	0.15 K @ 290 K
4.57 μm	2188 cm ⁻¹	23 cm ⁻¹	0.20 K @ 290 K
4.52 μm	2210 cm ⁻¹	23 cm ⁻¹	0.17 K @ 290 K
4.45 μm	2248 cm ⁻¹	23 cm ⁻¹	0.20 K @ 290 K
4.13 μm	2420 cm ⁻¹	40 cm ⁻¹	0.14 K @ 290 K
3.98 μm	2513 cm ⁻¹	40 cm ⁻¹	0.22 K @ 290 K
3.74 μm	2671 cm ⁻¹	100 cm ⁻¹	0.14 K @ 290 K
0.70 μm	N/A	0.05 μm @ % albedo

SOUNDER	INSAT Sounder
Satellites	INSAT-3D
Status (Sept 2005)	Being built – To be utilised in the period 2007 to ~ 2014
Mission	Temperature/humidity sounding
Instrument type	19-channel IR radiometer (including one VIS)
Coverage/cycle	6000 km x 6000 km in 3 h. Smaller areas in correspondingly shorter time intervals
Resolution (s.s.p.)	10.0 km

Wavelength	Wavenumber	Bandwidth	Radiometric accuracy (SNR or NEAT)
14.71 μm	680 cm^{-1}	13 cm^{-1}	1.5 K @ 320 K
14.37 μm	696 cm^{-1}	13 cm^{-1}	1.00 K @ 320 K
14.06 μm	711 cm^{-1}	13 cm^{-1}	0.50 K @ 320 K
13.96 μm	716 cm^{-1}	16 cm^{-1}	0.50 K @ 320 K
13.37 μm	748 cm^{-1}	16 cm^{-1}	0.50 K @ 320 K
12.66 μm	790 cm^{-1}	30 cm^{-1}	0.30 K @ 320 K
12.02 μm	832 cm^{-1}	50 cm^{-1}	0.15 K @ 320 K
11.03 μm	907 cm^{-1}	50 cm^{-1}	0.15 K @ 320 K
9.71 μm	1030 cm^{-1}	25 cm^{-1}	0.20 K @ 320 K
7.43 μm	1345 cm^{-1}	55 cm^{-1}	0.20 K @ 320 K
7.02 μm	1425 cm^{-1}	80 cm^{-1}	0.20 K @ 320 K
6.51 μm	1535 cm^{-1}	60 cm^{-1}	0.20 K @ 320 K
4.57 μm	2188 cm^{-1}	23 cm^{-1}	0.15 K @ 320 K
4.52 μm	2210 cm^{-1}	23 cm^{-1}	0.15 K @ 320 K
4.45 μm	2248 cm^{-1}	23 cm^{-1}	0.15 K @ 320 K
4.13 μm	2420 cm^{-1}	40 cm^{-1}	0.15 K @ 320 K
3.98 μm	2513 cm^{-1}	40 cm^{-1}	0.15 K @ 320 K
3.74 μm	2671 cm^{-1}	100 cm^{-1}	0.15 K @ 320 K
0.695 μm	N/A	0.05 μm	1000 @ 100 % albedo

SSM/I	Special Sensor Microwave - IMAGER
Satellites	DMSP F 8, 10, 11, 13, 14 and 15
Status (Sept 2005)	Operational – Utilisation period: 1987 to ~ 2006
Mission	Multi-purpose MW imager
Instrument type	4-frequency, 7-channel MW radiometer
Scanning technique	Conical: 53.1° zenith angle, swath 1400 km – Scan rate: 31.9 scan/min = 12.5 km/scan
Coverage/cycle	Global coverage once/day
Resolution (constant)	Changing with frequency, consistent with an antenna diameter of 61 x 66 cm

Central frequency (GHz)	Bandwidth (MHz)	Polarisations	Accuracy (NEAT)	IFOV	Pixel
19.35	400	V, H	0.43 K	45 x 68 km	25.0 x 12.5 km
22.235	400	V	0.73 K	40 x 60 km	25.0 x 12.5 km
37.0	1500	V, H	0.38 K	24 x 36 km	25.0 x 12.5 km
85.5	3000	V, H	0.71 K	11 x 16 km	12.5 x 12.5 km

SSM/T	Special Sensor Microwave - Temperature
Satellites	DMSP F 4 to 15
Status (Sept 2005)	Operational – Utilisation period: 1979 to ~ 2006
Mission	Temperature sounding in nearly-all-weather conditions
Instrument type	7-channel MW radiometer
Scanning technique	Cross-track: 7 steps of 174 km ssp, swath 1500 km - Along-track: one 48-km line each 8 s
Coverage/cycle	Global coverage once/day
Resolution (s.s.p.)	200 km IFOV

Central frequency (GHz)	Bandwidth (MHz)	Polarisation	Accuracy (NEAT)

50.50	400	H	0.60 K
53.20	400	H	0.40 K
54.35	400	H	0.40 K
54.90	400	H	0.40 K
58.40	350	H	0.50 K
58.825	300	H	0.40 K
59.40	250	H	0.40 K

SSM/T-2	Special Sensor Microwave - Humidity
Satellites	DMSP F 11, 12, 14, 15
Status (Sept 2005)	Operational – Utilisation period: 1991 to ~ 2006
Mission	Humidity sounding in nearly-all-weather conditions
Instrument type	5-channel MW radiometer
Scanning technique	Cross-track: 28 steps of 42 km ssp, swath 1500 km - Along-track: one 48-km line each 8 s
Coverage/cycle	Global coverage once/day
Resolution (s.s.p.)	48 km IFOV

Central frequency (GHz)	Bandwidth (MHz)	Polarisation	Accuracy (NEΔT)
91.655 \pm 1.250	3000	H	0.6 K
150.0 \pm 1.250	1500	H	0.6 K
183.31 \pm 7.0	500	H	0.6 K
183.31 \pm 3.0	1000	H	0.6 K
183.31 \pm 1.0	1500	H	0.8 K

SSMIS	Special Sensor Microwave – Imager/Sounder				
Satellites	DMSP F 16 and DMSP S 17 to 20				
Status (Sept 2005)	Operational – Utilisation period: 2003 to ~ 2015				
Mission	Multi-purpose MW imager with temperature/humidity sounding channels for improved precipitation				
Instrument type	21-frequency, 24-channel MW radiometer				
Scanning technique	Conical: 53.1° zenith angle, swath 1700 km – Scan rate: 31.9 scan/min = 12.5 km/scan				
Coverage/cycle	Global coverage once/day				
Resolution (constant)	Changing with frequency, consistent with an antenna diameter of 61 x 66 cm				
Central frequency (GHz)	Bandwidth (MHz)	Polarisations	Accuracy (NEΔT)	IFOV	Pixel

19.35	400	V, H	0.7 K	45 x 68 km	25.0 x 12.5 km
22.235	400	V	0.7 K	40 x 60 km	25.0 x 12.5 km
37.0	1500	V, H	0.5 K	24 x 36 km	25.0 x 12.5 km
50.3	400	H	0.4 K	18 x 27 km	37.5 x 12.5 km
52.8	400	H	0.4 K	18 x 27 km	37.5 x 12.5 km
53.596	400	H	0.4 K	18 x 27 km	37.5 x 12.5 km
54.4	400	H	0.4 K	18 x 27 km	37.5 x 12.5 km
55.5	400	H	0.4 K	18 x 27 km	37.5 x 12.5 km
57.29	350	-	0.5 K	18 x 27 km	37.5 x 12.5 km
59.4	250	-	0.6 K	18 x 27 km	37.5 x 12.5 km
60.792668 ± 0.357892 ± 0.050	120	V + H	0.7 K	18 x 27 km	37.5 x 12.5 km
60.792668 ± 0.357892 ± 0.016	32	V + H	0.6 K	18 x 27 km	75.0 x 12.5 km
60.792668 ± 0.357892 ± 0.006	12	V + H	1.0 K	18 x 27 km	75.0 x 12.5 km
60.792668 ± 0.357892 ± 0.002	6	V + H	1.8 K	18 x 27 km	75.0 x 12.5 km
60.792668 ± 0.357892	3	V + H	2.4 K	18 x 27 km	75.0 x 12.5 km
63.283248 ± 0.285271	3	V + H	2.4 K	18 x 27 km	75.0 x 12.5 km
91.655	3000	V, H	0.9 K	10 x 15 km	12.5 x 12.5 km
150	1500	H	0.9 K x km	37.5 x 12.5 km
183.31 ± 6.6	1500	H	1.2 K x km	37.5 x 12.5 km
183.31 ± 3.0	1000	H	1.0 K x km	37.5 x 12.5 km
183.31 ± 1.0	500	H	1.2 K x km	37.5 x 12.5 km

S-VISSR	Stretched Visible and Infrared Spin Scan Radiometer
Satellites	FY-2 A to F
Status (Sept 2005)	Operational – Utilisation period: 1997 to ~ 2015
Mission	Multi-purpose VIS/IR imagery and wind derivation by tracking clouds and water vapour features
Instrument type	5-channel VIS/IR radiometer
Coverage/cycle	Full disk each 30 min. Limited areas in correspondingly shorter time intervals
Resolution (s.s.p.)	5.0 km for IR channels; 1.25 km for the VIS channel

Central wavelength	Spectral interval	Radiometric accuracy (SNR or NE Δ)
0.77 μm	0.55 - 0.99 μm	1.5 @ 0.5 % albedo
3.75 μm	3.50 - 4.00 μm	0.4 K @ 300 K
6.95 μm	6.30 - 7.60 μm	0.5 K @ 300 K
10.8 μm	10.3 - 11.3 μm	0.3 K @ 300 K
12.0 μm	11.5 - 12.5 μm	0.3 K @ 300 K

TOU/SBUS	Total Ozone Unit and Solar Backscatter Ultraviolet Sounder
Satellites	FY-3 A to G
Status (Sept 2005)	Close to launch – Utilisation period: 2006 to ~ 2021
Mission	Ozone total column and vertical profile
Instrument type	Two UV spectro-radiometers. TOU with 6 channels of 1.2 nm bandwidth in the range 308-360 nm, SBUS with 12 discrete channels of 1 nm bandwidth in the range 252-380 nm
Scanning technique	TOU cross-track scanning, swath 3000 km, SBUS nadir view only
Coverage/cycle	TOU: global coverage once/day. SBUS: global coverage (200 km spacing) in 10 days. Daylight
Resolution	50 km for total ozone from TOU, 200 km for ozone profile from SBUS

VHRR (in GEO)	Very High Resolution Radiometer
Satellites	INSAT-1 A/B/C/D, INSAT-2 A/B/D/E, INSAT-3A, Kalpana
Status (Sept 2005)	Operational – Utilisation period: 1982 to ~ 2010
Mission	Multi-purpose VIS/IR imagery and wind derivation by tracking clouds and water vapour features
Instrument type	3-channel VIS/IR radiometer
Coverage/cycle	Full disk each 3 hours, more frequently on demand. Half-hourly triplets around 00 and 12 UT for winds
Resolution (s.s.p.)	8.0 km for IR channels; 2 km for the VIS channel

Central wavelength	Spectral interval	Radiometric accuracy (SNR or NE Δ)
0.65 μm	0.55 - 0.75 μm @ % albedo
6.40 μm	5.70 - 7.10 μm K @ K
11.5 μm	10.5 - 12.5 μm K @ 300 K

VIIRS	Visible/Infrared Imager Radiometer Suite
Satellites	NPP, NPOESS 1 to 6
Status (Sept 2005)	Being built – Utilisation period: 2006 to ~ 2026
Mission	Multi-purpose VIS/IR imagery, including ocean colour
Instrument type	22-channel VIS/IR radiometer, including a day/night 0.7 μm channel
Scanning technique	Cross-track: 16 parallel lines sampled by 2048 pixel of 800 m ssp and 32 parallel lines sampled by 4096 pixel of 400 m ssp; swath 3000 km. Along-track: one 11.9-km strip of 16 or 32 lines in 1.786 s.
Coverage/cycle	Global coverage twice/day (IR) or once/day (VIS)
Resolution (s.s.p.)	400 m for five AVHRR-like channels and the VIS day/night channel, 800 m for all other channels

Channel set and resolution	Central wavelength	Bandwidth or Spectral interval	Radiometric accuracy (SNR or NE Δ T)
High-quality radiometric channels, resolution 800 m	412 nm	20 nm @ % albedo
	445 nm	18 nm @ % albedo
	488 nm	20 nm @ % albedo
	555 nm	20 nm @ % albedo
	672 nm	20 nm @ % albedo
	746 nm	15 nm @ % albedo
	865 nm	39 nm @ % albedo
	1240 nm	20 nm @ % albedo
	1378 nm	15 nm @ % albedo
	1610 nm	60 nm @ % albedo
	2250 nm	50 nm @ % albedo
	3.70 μ m	0.18 μ m K @ 300 K
	4.05 μ m	0.155 μ m K @ 300 K
	8.55 μ m	0.30 μ m K @ 300 K
10.763 μ m	1.00 μ m K @ 300 K	
12.013 μ m	0.95 μ m K @ 300 K	
Day/night band, resolution 400 m	0.7 μ m	0.5 - 0.9 μ m @ % albedo
High-resolution imaging channels, resolution 400 m	0.64 μ m	0.60 - 0.68 μ m @ % albedo
	0.865 μ m	0.845 - 0.884 μ m @ % albedo
	1.61 μ m	1.58 - 1.64 μ m @ % albedo
	3.74 μ m	3.55 - 3.93 μ m K @ 300 K
	11.45 μ m	10.5 - 12.4 μ m K @ 300 K

VIRR	Visible and Infra Red Radiometer
Satellites	FY-3 A to G
Status (Sept 2005)	Close to launch – Utilisation period: 2006 to ~ 2021
Mission	Multi-purpose VIS/IR imagery with emphasis on vegetation and ocean colour
Instrument type	10-channel VIS/IR radiometer
Scanning technique	Cross-track: 2048 pixel of 800 m ssp, swath 2800 km - Along-track: six 1.1-km lines/s
Coverage/cycle	Global coverage twice/day (IR) or once/day (VIS)
Resolution (s.s.p.)	1.1 km IFOV

Central wavelength	Spectral interval	Radiometric accuracy (SNR or NE Δ T)
0.455 μ m	0.43 - 0.48 μ m @ % albedo
0.505 μ m	0.48 - 0.53 μ m @ % albedo
0.555 μ m	0.53 - 0.58 μ m @ % albedo
0.630 μ m	0.58 - 0.68 μ m @ % albedo
0.865 μ m	0.84 - 0.89 μ m @ % albedo
1.360 μ m	1.325 - 1.395 μ m @ % albedo
1.600 μ m	1.55 - 1.64 μ m @ % albedo
3.740 μ m	3.55 - 3.93 μ m K @ 300 K
10.80 μ m	10.3 - 11.3 μ m K @ 300 K
12.00 μ m	11.5 - 12.5 μ m K @ 300 K

A3.2 Research and Development satellites

Table A3.2.1 - List of instruments, corresponding satellites and utilisation period

Acronym	Full name	Satellites	Utilisation	Sheet
ACRIM-2	Active Cavity Radiometer Irradiance Monitor	UARS	1991-2005	
AIRS	Atmospheric Infra-Red Sounder	Aqua	2002-2008	X
ALI	Advanced Land Imager	NMP-EO-1	2000-2005	
ALT	Radar Altimeter	SeaSat	1978	
AMI-SAR	Active Microwave Instrument - SAR mode	ERS-1/2	1991-2006	X
AMI-Scat	Active Microwave Instrument - Scat mode	ERS-1/2	1991-2006	X
AMI-Wave	Active Microwave Instrument - Wave mode	ERS-1/2	1991-2006	X
AMR	Advanced Microwave Radiometer	OSTM	2008-2013	
AMSR-E	Advanced Microwave Scanning Radiometer for EOS (AMSR on ADEOS-2)	EOS-Aqua, ADEOS-2	2002-2008 2002-2003	X
APT	Automatic Picture Transmission	Nimbus-1/2	1964-1969	
ASAR	Advanced Synthetic Aperture Radar – SAR mode	Envisat	2002-2007	X
ASAR-wave	Advanced Synthetic Aperture Radar – wave mode	Envisat	2002-2007	X
ASTER	Advanced Spaceborne Thermal Emission and Reflection radiometer	Terra	1999-2006	X
ATSR	Along-Track Scanning Radiometer (including ATSR-2 and AATSR)	ERS-1/2, Envisat	1991-2007	X
AVCS	Advanced Vidicon Camera System	Nimbus-1/2	1964-1969	
AVNIR-1/2	Advanced Visible and Near-Infrared Radiometer	ADEOS-1 ALOS	1996-1997 2005-2010	X
AWiFS	Advanced Wide Field Sensor	IRS-P6	2003-2009	X
BlackJack	BlackJack	CHAMP	2000-2006	X
BUV	Backscatter Ultraviolet Spectrometer	Nimbus-4	1970-1980	
CERES	Clouds and the Earth's Radiant Energy System	TRMM, Terra, Aqua	1997-2006	X
CLAES	Cryogenic Limb Array Etalon Spectrometer	UARS	1991-2005	
CZCS	Coastal Zone Colour Scanner	Nimbus-7	1978-1994	
DCS	Data Collection System	Landsat-1/2/3	1972-1983	
DCS	Data Collection System	ADEOS-2	2002-2003	
Delta-2D	MW radiometer, conical scanning	Okean-O-1	1999-2000	
DPR	Dual-frequency Precipitation Radar	GPM-core	2010-2015	X
EOS-MLS	Microwave Limb Sounder	Aura	2004-2010	X
ERB	Earth Radiation Budget)	Nimbus-6/7	1975-1994	
ERBE	Earth Radiation Budget Experiment	ERBS, NOAA-9/10	1984-2001	
ESMR	Electrically Scanning Microwave Radiometer	Nimbus-5/6	1972-1983	
ETM	Enhanced Thematic Mapper	Landsat-6	-	
ETM+	Enhanced Thematic Mapper +	Landsat-7	1999-2006	X
FWS	Filter Wedge Spectrometer	Nimbus-4	1970-1980	
Geoton	Panchromatic and multispectral radiometer	Resurs-DK	2006-2009	X
GLAS	Geoscience Laser Altimeter System	ICESat	2003-2005	X
GLI	Global Imager	ADEOS-2	2002-2003	
GMI	GPM Microwave Imager	GPM-core	2010-2015	X
GOLPE	GPS Occultation and Passive reflection Experiment	SAC-C	2000-2002	
GOME	Global Ozone Monitoring Experiment	ERS-2	1995-2006	X
GOMOS	Global Ozone Monitoring by Occultation of Stars	Envisat	2002-2007	X
GPS	Global Positioning System	Landsat-4/5	1982-2005	
GPS/MET	Global Positioning System / Meteorology	MicroLab-1	1995-2001	
HALOE	Halogen Occultation Experiment	UARS	1991-2005	
HIRDLS	High-Resolution Dynamics Limb Sounder	Aura	2004-2010	X
HIRS	High-resolution Infra-Red Sounder	Nimbus-6	1975-1983	
HR	Haut Résolution	Pléiades-1/2	2008-2015	X
HRDI	High-Resolution Doppler Imager	UARS	1991-2005	
HRG	Haut Résolution Géométrique	SPOT-5	2002-2008	X
HRIR	High Resolution Infrared Radiometer	Nimbus-1/2/3	1964-1972	
HRS	Haut Résolution Stéréoscopique	SPOT-5	2002-2008	X
HRV	Haut Résolution dans le Visible	SPOT-1/2/3	1986-2005	X
HRVIR	Haut Résolution dans le Visible et l'Infra-Rouge	SPOT-4	1998-2006	X
HSB	Humidity Sounder for Brazil	Aqua	2002-2008	X
Hyperion	Hyperion	NMP-EO-1	2000-2005	
IDCS	Image Dissector Camera System	Nimbus-3/4	1969-1980	

Table A3.2.1 (cont.) - List of instruments, corresponding satellites and utilisation period

IGOS	Integrated GPS Occultation Receiver	COSMIC	2005-2010	
ILAS-I/II	Improved Limb Atmospheric Spectrometer	ADEOS-1 ADEOS-2	1996-1997 2002-2003	
IMG	Interferometric Monitor for Greenhouse gases	ADEOS-1	1996-1997	
IRIS	Infra-Red Interferometer Spectrometer	Nimbus-3/4	1969-1980	
IRLS	Interrogation, Recording and Location System	Nimbus-3/4	1969-1980	
ISAMS	Improved Stratospheric and Mesospheric Sounder	UARS	1991-2005	
ITPR	Infrared Temperature Profile Radiometer	Nimbus-5	1972-1983	
JMR	JASON Microwave Radiometer	JASON	2001-2006	X
Kondor	Data collection system	Okean-O1, SICH-1	1986-1996	
LEISA	Linear Etalon Imaging Spectrometer Array	NMP-EO-1	2000-2005	
LIS	Lightning Imaging Sensor	TRMM	1997-2006	X
LISS-1	Linear Imaging Self-Scanning Sensor - 1	IRS-1A/1B/1E	1988-????	
LISS-2-A/B	Linear Imaging Self-Scanning Sensor - 2-A/B	IRS-1A/1B	1988-????	
LISS-2-M	Linear Imaging Self-Scanning Sensor - 2-M	IRS-P2	1994-????	
LISS-3	Linear Imaging Self-Scanning Sensor - 3	IRS-1C/1D/P6	1995-2009	X
LISS-4	Linear Imaging Self-Scanning Sensor - 4	IRS-P6	2003-2009	X
LRIR	Limb Radiance Inversion Radiometer	Nimbus-6	1975-1983	
MADRAS	Microwave Analysis & Detection of Rain & Atmospheric Structures	Megha-Tropiques	2009-2014	X
MEOSS	Monocular Electro-Optical Stereo Scanner	IRS-1E/P1	-	
MERIS	Medium Resolution Imaging Spectrometer	Envisat	2002-2007	X
MESSR	Multi-spectral Electronic Self-Scanning Radiometer	MOS 1/1B	1987-1996	
MIPAS	Michelson Interferometer for Passive Atmospheric Sounding	Envisat	2002-2007	X
MISR	Multi-angle Imaging Spectro-Radiometer	Terra	1999-2006	X
MLS	Microwave Limb Sounder	UARS	1991-2005	
MODIS	Moderate-resolution Imaging Spectro-radiometer	Terra, Aqua	1999-2008	X
MOPITT	Measurement Of Pollution In The Troposphere	Terra	1999-2006	X
MOS	Multispectral Opto-electronic Scanner	IRS-P3	1996-????	
MP-900B	TV camera	Resurs-O1-4	1998-1999	
MRIR	Medium Resolution Infrared Radiometer	Nimbus-2/3	1966-1972	
MS	Multispectral radiometer	Monitor-E	2005-2008	X
MSMR	Multi-frequency Scanning Microwave Radiometer	IRS-P4	1999-2005	X
MSR	Microwave Scanning Radiometer	MOS 1/1B	1987-	

			1996	
MSS	Multi-Spectral Scanner)	Landsat-1/2/3	1972-1983	
MSU-E & E1	Multispectral VNIR radiometer	Resurs-O1 1 to 4	1985-1999	
MSU-EU	Multispectral VNIR radiometer	SICH-1M	-	
MSU-M	Multispectral VNIR radiometer	Okean-O-1	1999-2000	
MSU-SK & SK1	Multispectral VNIR/IR conical scanning radiometer	Resurs-O1 1 to 4, Okean-O1, Okean-O, SICH-1	1985-1998 1986-1994 1999-2000	
MSU-V	Multispectral VIS/IR radiometer	Okean-O-1	1999-2000	
MTVZA-OK	Multispectral VIS/IR/MW radiometer	SICH-1M	-	
MUSE	Monitor of Ultraviolet Solar Energy	Nimbus-3/4	1969-1980	
MWR	Micro-Wave Radiometer	ERS-1/2, Envisat	1991-2007	X
MWR	Microwave Radiometer, no-scanning	Okean-O1, SICH-1	1986-1996	
NEMS	Nimbus-E Microwave Sounder	Nimbus-5	1972-1983	
NRA	NASA Radar Altimeter	Topex-Poseidon	1992-2006	
NSCAT	NASA Scatterometer	ADEOS-1	1996-1997	
OCM	Ocean Color Monitor	IRS-P4	1999-2005	X
OCTS	Ocean Color and Temperature Scanner	ADEOS-1	1996-1997	
OLI	Operational Land Imager	LDCM	2010→	X
OMI	Ozone Monitoring Instrument	Aura	2004-2010	X
OPS	Optical Sensor	JERS	1992-1998	
OTD	Optical Transient Detector	MicroLab-1	1995-2001	
PALSAR	Phased-Array L-band Synthetic Aperture Radar	ALOS	2005-2010	X
PAN	Panchromatic Camera	IRS-1C/1D	1995-????	
PAN	Panchromatic radiometer	Monitor-E	2005-2008	X
PAN-A, PAN-F	Panchromatic Cameras	IRS-P5	2005-2010	X
PASTEC	Technology Demonstration Passenger	SPOT-4	1998-2006	
PEM	Particle Environment Monitor	UARS	1991-2005	
PMR	Pressure Modulator Radiometer	Nimbus-6	1975-1983	

Table A3.2.1 (cont.) - List of instruments, corresponding satellites and utilisation period

POAM	Polar Ozone and Aerosol Measurement	SPOT-3/4	1993-2006	X
POLDER	Polarization and Directionality of the Earth's Reflectances	ADEOS-1/2, PARASOL	1996-1997 2004-2006	X
Poseidon-2	Poseidon-2	JASON	2001-2006	X
Poseidon-3	Poseidon-3	OSTM	2008-2013	
PR	Precipitation Radar	TRMM	1997-2006	X
PRISM	Panchromatic Remote-sensing Instrument for Stereo Mapping	ALOS	2005-2010	X
R225	Microwave Radiometer, no-scanning	Okean-O-1	1999-2000	
R600	Microwave Radiometer, no-scanning	Okean-O-1	1999-2000	
RA, RA-2	Radar Altimeter	ERS-1/2, Envisat	1991-2007	X
RBV	Return-Beam Vidicon camera	Landsat-1/2/3	1972-1983	
RIS	Retroreflector In Space	ADEOS-1	1996-1997	
RLSBO	Side-looking radar	Okean-O1, Okean-O, SICH	1986-1994 1999-2000	
RM-08	MW radiometer, conical scanning	Okean-O1, SICH	1986-1996	
SAGE-II	Stratospheric Aerosol and Gas Experiment - II	ERBS	1984-2001	
SAM-II	Stratospheric Aerosol Measurement - II	Nimbus-7	1978-1994	
SAMS	Stratospheric and Mesospheric Sounder	Nimbus-7	1978-1994	
SAPHIR	Sondeur Atmospherique du Profil d'Humidite Intertropicale par Radiometrie	Megha-Tropiques	2009-2014	X
SAR	Synthetic Aperture Radar	SeaSat	1978	
SAR	Synthetic Aperture Radar	JERS	1992-1998	
SAR-Travers	Two-frequency SAR	Resurs-O1-1	1985-1986	
SASS	SeaSat-A Scatterometer System	SeaSat	1978	
SBUV	Solar Backscatter Ultraviolet Spectrometer	Nimbus-7	1978-1994	
SCAMS	Scanning Microwave Spectrometer	Nimbus-6	1975-1983	
ScaRaB	Scanner for Radiation Budget	Megha-Tropiques, Resurs-O1-4	2009-2014 1998-1999	X
SCIAMACHY	Scanning Imaging Absorption Spectrometer for Atmospheric Cartography	Envisat	2002-2007	X
SCR	Selective Chopper Radiometer	Nimbus-4/5	1970-1983	
SCRM	Surface Composition Mapping Radiometer	Nimbus-5	1972-1983	
SeaWiFS	Sea-viewing Wide Field-of-view Sensor	SeaStar	1997-2006	X
SeaWinds	SeaWinds	QuickSCAT, ADEOS-2	1999-2006 2002-2003	X
SIRS	Satellite Infra-Red Spectrometer	Nimbus-3/4	1969-	

			1980	
SMMR	Scanning Multichannel Microwave Radiometer) [Nimbus-7, SeaSat	1978- 1994	
SOLSTICE	Solar/Stellar Irradiance Comparison Experiment	UARS	1991- 2005	
SSALT	Single-frequency Solid-state Altimeter	Topex-Poseidon	1992- 2006	
SUSIM	Solar Ultraviolet Spectral Irradiance Monitor	UARS	1991- 2005	
TANSO-CAI	Thermal And Near infrared Sensor for carbon Observations - Cloud and Aerosol Imager	GOSAT	2008- 2013	X
TANSO-FTS	Thermal And Near infrared Sensor for carbon Observations - Fourier Transform Spectrometer	GOSAT	2008- 2013	X
TES	Tropospheric Emission Spectrometer	Aura	2004- 2010	X
THIR	Temperature-Humidity Infrared Radiometer	Nimbus-4/5/6/7	1970- 1994	
TM	Thematic Mapper	Landsat-4/5	1982- 2005	
TMI	TRMM Microwave Imager	TRMM	1997- 2006	X
TMR	TOPEX Microwave Radiometer	Topex-Poseidon	1992- 2006	
TOMS	Total Ozone Mapping Spectrometer	Nimbus-7, ADEOS-1	1978- 1994 1996- 1997	
Trasser	Polarisation spectro-radiometer	Okean-O1-3, Okean-O-1	1988- 1990 1999- 2000	
TWERLE	Tropical Wind Energy-conversion and Reference Level Experiment	Nimbus-6	1975- 1983	
Végétation	Végétation	SPOT-4/5	1998- 2008	X
VIRR	Visible and Infra-Red Radiometer	SeaSat	1978	
VIRS	Visible and Infra-Red Scanner	TRMM	1997- 2006	X
VTIR	Visible and Thermal Infrared Radiometer	MOS 1/1B	1987- 1996	
WIFS	Wide Field Sensor	IRS-1C/1D/P3	1995- ????	
WINDII	Wind Doppler Imaging Interferometer	UARS	1991- 2005	
WindSat	WindSat	Coriolis	2003- 2008	X
X-AE	X-ray Astronomy Experiment	IRS-P3	1996- ????	

AIRS	Atmospheric Infra-Red Sounder
Satellite	EOS-Aqua
Status (Sept 2005)	Operational – Utilised in the period 2002 to ~ 2008
	TO BE COMPILED

AMI-SAR	Active Microwave Instrument - SAR mode
Satellites	ERS-1 and ERS-2
Status (Sept 2005)	Operational – Utilised in the period 1991 to ~ 2006
	TO BE COMPILED

AMI-Scat	Active Microwave Instrument - Scat mode
Satellites	ERS-1 and ERS-2
Status (Sept 2005)	Operational – Utilised in the period 1991 to ~ 2006
	TO BE COMPILED

AMI-Wave	Active Microwave Instrument - Wave mode
Satellites	ERS-1 and ERS-2
Status (Sept 2005)	Operational – Utilised in the period 1991 to ~ 2006
	TO BE COMPILED
	TO BE COMPILED

AMSR-E	Advanced Microwave Scanning Radiometer for EOS
Satellites	EOS-Aqua (AMSR-E) and ADEOS-2 (AMSR)
Status (mid-2005)	Operational (on EOS-Aqua) - Utilisation period: 2002 to ~ 2008
Mission	Multi-purpose MW imager
Instrument type	MW radiometer with 6 frequencies / 12 channels (AMSR: 8 frequencies / 14 channels)
Scanning technique	Conical: 55° zenith angle; swath: 1450 km (AMSR: 1600 km) - Scan rate: 40 scan/min = 10 km/scan
Coverage/cycle	Global coverage once/day
Resolution	Changing with frequency, consistent with an antenna diameter of 1.6 m (AMSR: 2.0 m)

Central frequency (GHz)	Bandwidth (MHz)	Polarisations	Accuracy (NEΔT)	IFOV	Pixel
6.925	350	V, H	0.3 K	43 x 75 km	10 x 10 km
10.65	100	V, H	0.6 K	29 x 51 km	10 x 10 km
18.7	200	V, H	0.6 K	16 x 27 km	10 x 10 km
23.8	400	V, H	0.6 K	14 x 21 km	10 x 10 km
36.5	1000	V, H	0.6 K	9 x 14 km	10 x 10 km
50.2 (AMSR)	200	H	1.8 K	7 x 10 km	10 x 10 km
53.8 (AMSR)	400	H	1.6 K	7 x 10 km	10 x 10 km
89.0	3000	V, H	1.1 K	4 x 6 km	5 x 5 km

ASAR	Advanced Synthetic Aperture Radar - SAR mode
Satellite	Envisat
Status (Sept 2005)	Operational – Utilised in the period 2002 to ~ 2007
	TO BE COMPILED

ASAR-Wave	Advanced Synthetic Aperture Radar - Wave mode
Satellite	Envisat
Status (Sept 2005)	Operational – Utilised in the period 2002 to ~ 2007
	TO BE COMPILED

ASTER	Advanced Spaceborne Thermal Emission and Reflection radiometer
Satellite	EOS-Terra
Status (Sept 2005)	Operational – Utilised in the period 1999 to ~ 2006
	TO BE COMPILED

ATSR	Along-Track Scanning Radiometer
Satellites	ERS-1 (ATSR), ERS-2 (ATSR-2) and Envisat (AATSR)
Status (Sept 2005)	Operational – Utilised in the period 1991 to ~ 2007
	TO BE COMPILED

AVNIR-2	Advanced Visible and Near-Infrared Radiometer - 2
Satellites	ALOS and ADEOS-1 (AVNIR)
Status (mid-2005)	Close to be launched – To be utilised in the period 2005 to ~ 2010 (AVNIR: 2002-2003)
Mission	Vegetation observation
Instrument type	4-channel VIS/NIR radiometer (AVNIR: 5 channels)
Scanning technique	Bushbroom, 7000 pixel/line, swath 70 km ssp, possible to be pointed cross-track within a swath of 1400 km
Coverage/cycle	Global coverage in 46 days, in daylight. With strategic pointing, one place can be observed each 2 days.
Resolution (s.s.p.)	10 m IFOV

Central wavelength	Spectral interval	Radiometric accuracy (SNR)
0.46 μm	0.42 - 0.50 μm	200 @ 25 % albedo
0.56 μm	0.52 – 0.60 μm	200 @ 29 % albedo
0.65 μm	0.61 – 0.69 μm	200 @ 41 % albedo
0.825 μm	0.76 – 0.89 μm	200 @ 59 % albedo
0.60 μm (AVNIR)	0.52 – 0.69 μm	100 @ 100 % albedo or 5 @ 3.3 % albedo

AWiFS	Advanced Wide Field Sensor
Satellite	IRS-P6 (ResourceSat-1)
Status (mid-2005)	Operational - Utilisation period: 2003 to ~ 2009
Mission	Land and vegetation observation
Instrument type	Two parallel radiometers, 4 VIS/NIR/SWIR channels
Scanning technique	Bushbroom, 12000 pixel/line, swath 740 km (with two instruments)
Coverage/cycle	Global coverage in 5 days, in daylight
Resolution (s.s.p.)	56 m IFOV

Central wavelength	Spectral interval	Radiometric accuracy (SNR)
0.555 μm	0.52 – 0.59 μm @ % albedo
0.650 μm	0.62 – 0.68 μm @ % albedo
0.815 μm	0.77 – 0.86 μm @ % albedo
1.625 μm	1.55 – 1.70 μm @ % albedo

BlackJack	BlackJack
Satellite	CHAMP
Status (Sept 2005)	Operational – Utilised in the period 2000 to ~ 2006
	TO BE COMPILED

CERES	Clouds and the Earth's Radiant Energy System
Satellites	TRMM, EOS-Terra and EOS-Aqua
Status (Sept 2005)	Operational – Utilised in the period 1997 to ~ 2008
	TO BE COMPILED

DPR	Dual-frequency Precipitation Radar
Satellite	GPM-core
Status (Sept 2005)	Planned – To be utilised in the period 2010 to ~ 2015
	TO BE COMPILED

EOS-MLS	Microwave Limb Sounder
Satellite	EOS-Aura
Status (Sept 2005)	Operational – Utilised in the period 2004 to ~ 2010
	TO BE COMPILED

ETM+	Enhanced Thematic Mapper +
Satellite	Landsat-7
Status (Sept 2005)	Operational – Utilised in the period 1999 to ~ 2006
	TO BE COMPILED

Geoton	Panchromatic and multispectral radiometer	
Satellite	Resurs-DK	
Status (Sept 2005)	Planned – To be utilisation in the period 2006 to ~ 2009	
Mission	Land and vegetation observation	
Instrument type	3-channel VIS/NIR radiometer (multispectral), 1 channel in panchromatic mode	
Scanning technique	Bushbroom, 12000 pixel/line; swath 30 km addressable within an area of regard of 450 km	
Coverage/cycle	Global coverage in 80 days, in daylight; locally more frequent by strategic pointing	
Resolution (s.s.p.)	2-3 m in multi-spectral mode, 1 m in panchromatic mode	

Central wavelength	Spectral interval	Radiometric accuracy (SNR)
0.55 μm	0.5 – 0.6 μm @ % albedo
0.65 μm	0.6 – 0.7 μm @ % albedo
0.75 μm	0.7 – 0.8 μm @ % albedo

GLAS	Geoscience Laser Altimeter System
Satellite	ICESat
Status (Sept 2005)	Operational – Utilised in the period 2003 to ~ 2005
	TO BE COMPILED

GMI	GPM Microwave Imager
Satellite	ICESat
Status (Sept 2005)	Planned – To be utilised in the period 2010 to ~ 2015
TO BE COMPILED	

GOME	Global Ozone Monitoring Experiment
Satellite	ERS-2
Status (Sept 2005)	Operational – Utilised in the period 1995 to ~ 2006
Mission	Ozone profile and total-column or gross profile of other species. Tracked species: BrO, ClO, H ₂ O, HCHO, NO, NO ₂ , NO ₃ , O ₂ , O ₃ , O ₄ , OClO, SO ₂ and aerosol
Instrument type	UV/VIS grating spectrometer, four bands, 4096 channels, with 3 polarisation channels
Scanning technique	Cross-track: 3 steps of 40 km or 320 km ssp, swath 120 or 960 km - Along-track: one 40-km line each 6 s
Coverage/cycle	Global coverage each 24 days with high resolution or 3 days with low resolution. Daylight only
Resolution (s.s.p.)	40 x 40 km ² associated to 120 km swath or 40 x 320 km ² associated to 960 km swath

Spectral range	Number of channels	Spectral resolution	SNR at specified input radiance
240 - 295 nm	1024	0.22 nm @ % albedo
290 - 405 nm	1024	0.24 nm @ % albedo
400 - 605 nm	1024	0.40 nm @ % albedo
590 - 790 nm	1024	0.40 nm @ % albedo
290 - 790 nm	3	292-402 nm, 402-597 nm, 597-790 nm @ % albedo

GOMOS	Global Ozone Monitoring by Occultation of Stars
Satellite	Envisat
Status (Sept 2005)	Operational – Utilised in the period 2002 to ~ 2007
TO BE COMPILED	

HIRDLS	High-Resolution Dynamics Limb Sounder
Satellite	EOS-Aura
Status (Sept 2005)	Operational – Utilised in the period 2004 to ~ 2010
TO BE COMPILED	

HR	Haut Résolution
Satellites	Pléiades 1 and 2
Status (mid-2005)	Under development - To be utilised in the period 2008 to ~ 2015
Mission	Land and vegetation observation. Digital Elevation Model (DEM)
Instrument type	Two parallel radiometers, 5 VNIR channels, 4 multi-spectral (MS), one panchromatic (PAN)
Scanning technique	Bushbroom, 7500 pixel/line (MS), 30000 pixel/line (PAN), swath 20 km ssp; cross-track and along-track pointing capability by up to ± 30° off-nadir. By combining cross- and along-track capabilities, composite images of 120 km x 120 km may be built.

	Stereoscopic capability in-orbit and between successive orbits	
Coverage/cycle	Global coverage in 26 days, in daylight. With strategic pointing, one place can be observed each 2 days.	
Resolution (s.s.p.)	2.8 m (MS), 0.7 m (PAN)	
Central wavelength	Spectral interval	Radiometric accuracy (SNR)
0.49 μm	0.45 – 0.53 μm @ % albedo
0.55 μm	0.52 – 0.58 μm @ % albedo
0.66 μm	0.62 – 0.70 μm @ % albedo
0.83 μm	0.78 – 0.89 μm @ % albedo
0.69 μm (PAN)	0.48 – 0.90 μm @ % albedo

HRG	Haut Résolution Géométrique
Satellite	SPOT-5
Status (mid-2005)	Operational – Utilisation period: 2002 to ~ 2009
Mission	Land and vegetation observation. Digital Elevation Model (DEM)
Instrument type	Two parallel radiometers, 5 VIS/NIR/SWIR channels, 4 multi-spectral (MS), one panchromatic (PAN)
Scanning technique	Bushbroom, 6000 pixel/line (MS), 12000 pixel/line (PAN), swath 60 km ssp (117 km with two instruments), cross-track pointing capability within a range of ± 450 km. Stereoscopic capability between successive orbits
Coverage/cycle	Global coverage in 26 days, in daylight. With strategic pointing, one place can be observed each 3 days.
Resolution (s.s.p.)	10 m (the three VNIR channels), 20 m (the SWIR channel), 5 m (PAN) with <i>super-mode</i> at 2.5 m

Central wavelength	Spectral interval	Radiometric accuracy (SNR)
0.545 μm	0.49 – 0.61 μm @ % albedo
0.645 μm	0.61 – 0.68 μm @ % albedo
0.835 μm	0.78 – 0.89 μm @ % albedo
1.645 μm	1.58 – 1.75 μm @ % albedo
0.59 μm (PAN) (2 shifted channels)	0.49 – 0.69 μm @ % albedo

HRS	Haut Résolution Stéréoscopique
Satellite	SPOT-5
Status (mid-2005)	Operational – Utilisation period: 2002 to ~ 2009
Mission	Digital Elevation Model (DEM) by in-orbit stereoscopy
Instrument type	Single VIS channel (0.51-0.73 μm), SNR @ % albedo
Scanning technique	Bushbroom, 12000 pixel/line, swath 120 km ssp, along-track fore- and aft- pointing by $\pm 20^\circ$
Coverage/cycle	Global coverage in 26 days, in daylight
Resolution (s.s.p.)	10 m IFOV cross-track, 5 m sampling along-track

HRV	Haut Résolution dans le Visible
Satellites	SPOT-1, SPOT-2, SPOT-3
Status (mid-2005)	Operational (on SPOT-2) - Utilisation period: 1986 to ~ 2006
Mission	Land and vegetation observation. Digital Elevation Model (DEM)
Instrument type	Two parallel radiometers, 4 VIS/NIR channels, three multi-spectral (MS), one panchromatic (PAN)
Scanning technique	Bushbroom, 3000 pixel/line (MS), 6000 pixel/line (PAN), swath 60 km ssp (117 km with two instruments), cross-track pointing capability within a range of ± 450 km. Stereoscopic capability between successive orbits
Coverage/cycle	Global coverage in 26 days, in daylight. With strategic pointing, one place can be observed each 3 days.
Resolution (s.s.p.)	20 m (MS), 10 (PAN)

Central wavelength	Spectral interval	Radiometric accuracy (SNR)
0.545 μm	0.50 – 0.59 μm @ % albedo
0.645 μm	0.61 – 0.68 μm @ % albedo
0.84 μm	0.79 – 0.89 μm @ % albedo

0.62 μm (PAN)	0.51 – 0.73 μm @ % albedo
--------------------------	---------------------------	------------------------

HRVIR	Haut Résolution dans le Visible et l'Infra-Rouge
Satellite	SPOT-4
Status (mid-2005)	Operational - Utilisation period: 1998 to ~ 2007
Mission	Land and vegetation observation. Digital Elevation Model (DEM)
Instrument type	Two parallel radiometers, 4 VIS/NIR/SWIR multi-spectral (MS) channels, one also panchromatic (PAN)
Scanning technique	Bushbroom, 3000 pixel/line (MS), 6000 pixel/line (PAN), swath 60 km ssp (117 km with two instruments), cross-track pointing capability within a range of ± 450 km. Stereoscopic capability between successive orbits
Coverage/cycle	Global coverage in 26 days, in daylight. With strategic pointing, one place can be observed each 3 days.
Resolution (s.s.p.)	20 m (MS), 10 (PAN)

Central wavelength	Spectral interval	Radiometric accuracy (SNR)
0.545 μm	0.50 – 0.59 μm @ % albedo
0.645 μm (MS)	0.61 – 0.68 μm @ % albedo
0.645 μm (PAN)	0.61 – 0.68 μm @ % albedo
0.84 μm	0.79 – 0.89 μm @ % albedo
1.64 μm	1.58 – 1.75 μm @ % albedo

HSB	Humidity Sounder for Brazil
Satellite	EOS-Aqua
Status (Sept 2005)	Operational – Utilised in the period 2002 to ~ 2008
	TO BE COMPILED

JMR	JASON Microwave Radiometer
Satellite	Jason (it follows TMR of TOPEX-Poseidon and will be followed by AMR on OSTM)
Status (Sept 2005)	Operational – Utilised in the period 2001 to ~ 2006. To continue with Poseidon-3 on OSTM till ~ 2013
Mission	Water vapour correction for the Poseidon-2 radar altimeter
Instrument type	3-frequency MW radiometer, 18.7, 23.8 and 34 GHz
Scanning technique	Nadir-only viewing, associated to the Poseidon-2 radar altimeter
Coverage/cycle	Global coverage in 30 days
Resolution (s.s.p.)	25 km

LIS	Lightning Imaging Sensor
Satellite	TRMM
Status (Sept 2005)	Operational – Utilised in the period 1997 to ~ 2006
	TO BE COMPILED

LISS-3	Linear Imaging Self-Scanning Sensor - 3
Satellites	IRS-1C, IRS-1D and IRS-P6 (ResourceSat-1)
Status (mid-2005)	Operational - Utilisation period: 1995 to ~ 2009
Mission	Land and vegetation observation
Instrument type	Two parallel radiometers, 4 VIS/NIR/SWIR channels
Scanning technique	Bushbroom, 6000 pixel/line (SWIR 2100 pixel/line on IRS-1C/1D), swath 140 km (with two instruments)
Coverage/cycle	Global coverage in 24 days, in daylight
Resolution (s.s.p.)	IRS-P6: 23.5 m in all channels. IRS-1C/1D: 23.5 m (the three VNIR channels), 70 m (the SWIR channel)

Central wavelength	Spectral interval	Radiometric accuracy (SNR)
0.555 μm	0.52 – 0.59 μm @ % albedo
0.650 μm	0.62 – 0.68 μm @ % albedo
0.815 μm	0.77 – 0.86 μm @ % albedo
1.625 μm	1.55 – 1.70 μm @ % albedo

LISS-4	Linear Imaging Self-Scanning Sensor - 4
Satellite	IRS-P6 (ResourceSat-1)
Status (mid-2005)	Operational – Utilisation period: 2003 to ~ 2009
Mission	Land and vegetation observation
Instrument type	3-channel VIS/NIR radiometer, one camera each channel
Scanning	Bushbroom, 4096 pixel/line per camera; swath 23.9 km if the 3 cameras are used each

technique	for 1 different channel (thus multi-spectral), or 70 km if all cameras are used for viewing parallel strips in the same channel (thus panchromatic). Cross-track pointing capability $\pm 26^\circ$ for stereoscopy in between orbits
Coverage/cycle	Global coverage in 24 days, in daylight. 5 days for a target area by using cross-track pointing
Resolution (s.s.p.)	5.8 m IFOV

Central wavelength	Spectral interval	Radiometric accuracy (SNR)
0.555 μm	0.52 – 0.59 μm @ % albedo
0.650 μm	0.62 – 0.68 μm @ % albedo
0.815 μm	0.77 – 0.86 μm @ % albedo

MADRAS	Microwave Analysis & Detection of Rain & Atmospheric Structures
Satellite	Megha-Tropiques
Status (mid-2005)	Planned - To be utilised in the period 2009 to ~ 2014
Mission	Contribution to the Global Precipitation Measurement mission (GPM)
Instrument type	MW radiometer with 5 frequencies / 9 channels
Scanning technique	Conical: 56° zenith angle; swath: 1740 km - Scan rate: 24.6 scan/min = 16 km/scan
Coverage/cycle	Intertropical coverage 2 to 5 times/day depending on latitude (max coverage at 15°N and 15°S)
Resolution	IFOV ranging from 7 km at 157 GHz to 50 km at 18.7 GHz

Central frequency (GHz)	Bandwidth (MHz)	Polarisations	Radiometric accuracy (NE Δ T)	IFOV	Pixel
18.7	180	V, H	1.0 K	40 x 60 km	40 x 40 km
23.8	360	V	0.86 K	40 x 60 km	40 x 40 km
36.5	900	V, H	0.72 K	40 x 60 km	40 x 40 km
89.0	1100	V, H	1.23 K	11 x 16 km	10 x 10 km
157.0	1100	V, H	3.3 K	6 x 9 km	6 x 6 km

MERIS	Medium Resolution Imaging Spectrometer
Satellite	Envisat
Status (Sept 2005)	Operational – Utilised in the period 2002 to ~ 2007
	TO BE COMPILED

MIPAS	Michelson Interferometer for Passive Atmospheric Sounding
Satellite	Envisat
Status (Sept 2005)	Operational – Utilised in the period 2002 to ~ 2007
	TO BE COMPILED

MISR	Multi-angle Imaging Spectro-Radiometer
Satellite	EOS-Terra
Status (Sept 2005)	Operational – Utilised in the period 1999 to ~ 2006
	TO BE COMPILED

MODIS	Moderate-resolution Imaging Spectro-radiometer
Satellites	EOS-Terra and EOS-Aqua
Status (Sept 2005)	Operational – Utilised in the period 1999 to ~ 2008

2005)	
	TO BE COMPILED

MOPITT	Measurement Of Pollution In The Troposphere
Satellites	EOS-Terra
Status (Sept 2005)	Operational – Utilised in the period 1999 to ~ 2006
	TO BE COMPILED

MS	Multi-Spectral radiometer
Satellite	Monitor-E
Status (Sept2005)	Operational – Utilisation period: 2005 to ~ 2008
Mission	Land and vegetation observation
Instrument type	3-channel VIS/NIR radiometer
Scanning technique	Bushbroom, 8000 pixel/line; swath 160 km addressable within an area of regard of 890 km
Coverage/cycle	Global coverage in 14 days, in daylight; locally more frequent by strategic pointing
Resolution (s.s.p.)	20 m IFOV

Central wavelength	Spectral interval	Radiometric accuracy (SNR)
0.565 μm	0.54 – 0.59 μm @ % albedo
0.660 μm	0.63 – 0.69 μm @ % albedo
0.845 μm	0.79 – 0.90 μm @ % albedo

MSMR	Multi-frequency Scanning Microwave Radiometer				
Satellite	IRS-P4 (OceanSat-1)				
Status (mid-2005)	Operational – Utilisation period: 1999 to ~ 2006				
Mission	Sea-surface temperature, wind on sea-surface, total-column water vapour over the sea				
Instrument type	MW radiometer with 4 frequencies / 8 channels				
Scanning technique	Conical: 55° zenith angle; swath: 1360 km - Scan rate: 11.16 scan/min = 36 km/scan				
Coverage/cycle	Global coverage once/day				
Resolution	Changing with frequency, consistent with an antenna diameter of 80 cm				

Central frequency	Bandwidth	Polarisations	Radiometric accuracy (NE Δ T)	IFOV	Pixel
6.6 GHz	350 MHz	V, H	< 1.0 K	68 x 105 km	50 x 36 km
10.65 GHz	100 MHz	V, H	< 1.0 K	43 x 66 km	50 x 36 km
18.0 GHz	200 MHz	V, H	< 1.0 K	26 x 40 km	25 x 36 km
21.0 GHz	400 MHz	V, H	< 1.0 K	22 x 34 km	25 x 36 km

MWR	Micro-Wave Radiometer	
Satellites	ERS-1, ERS-2 and Envisat	
Status (Sept 2005)	Operational – Utilised in the period 1991 to ~ 2007	
	TO BE COMPILED	

OCM	Ocean Color Monitor	
Satellite	IRS-P4 (OceanSat-1)	
Status (mid-2005)	Operational – Utilisation period: 1999 to ~ 2006	
Mission	Ocean colour and aerosol	
Instrument type	8-channel VIS/NIR radiometer	
Scanning technique	Bushbroom, 6000 pixel/line (3700 useful), swath 1420 km	
Coverage/cycle	Global coverage in 2 days, in daylight	
Resolution (s.s.p.)	360 m x 236 m IFOV	

Central wavelength	Band width	Radiometric accuracy (SNR @ specified NESR)
412 nm	20 nm	1300 @ 0.26 W m ⁻² sr ⁻¹ μm^{-1}
442 nm	20 nm	1300 @ 0.23 W m ⁻² sr ⁻¹ μm^{-1}
489 nm	20 nm	1300 @ 0.17 W m ⁻² sr ⁻¹ μm^{-1}

512 nm	20 nm	1500 @ 0.17 W m ⁻² sr ⁻¹ μ ⁻¹
557 nm	20 nm	1500 @ 0.15 W m ⁻² sr ⁻¹ μ ⁻¹
670 nm	20 nm	1800 @ 0.10 W m ⁻² sr ⁻¹ μ ⁻¹
768 nm	40 nm	1800 @ 0.05 W m ⁻² sr ⁻¹ μ ⁻¹
867 nm	40 nm	2000 @ 0.08 W m ⁻² sr ⁻¹ μ ⁻¹

OLI	Operational Land Imager
Satellites	LDCM
Status (Sept 2005)	Planned – To be utilised in the period 2010 onwards
	TO BE COMPILED

OMI	Ozone Monitoring Instrument
Satellite	EOS-Aura
Status (Sept 2005)	Operational – Utilised in the period 2004 to ~ 2010
	TO BE COMPILED

PALSAR	Phased-Array L-band Synthetic Aperture Radar
Satellite	ALOS
Status (mid-2005)	Close to be launched – To be utilised in the period 2005 to ~ 2010
Mission	High-resolution all-weather soil moisture and ocean surface features observation
Instrument type	L-band SAR, frequency 1.27 GHz, multi-polarisation and variable pointing/resolution
Scanning technique	Side-looking, 10-51° off-nadir, swath 40 to 350 km, depending on operation mode – See table
Coverage/cycle	Global coverage in minimum 2 weeks, depending on operation mode (duty cycle 17.5 min/orbit)
Resolution	7 to 100 m, depending on operation mode – See table

Operation mode	Resolution	Swath	Polarisation	Incidence angle
Highest resolution	7-44 m	40-70 km	HH or VV	8-60°
High resolution	14-89 m	40-70 km	HH/HV or VV/VH	8-60°
ScanSAR	100 m	250-350 km	HH or VV	18-43°
Polarimetry	24-89 m	30 km	HH/HV + VV/VH	8-30°

PAN	Panchromatic radiometer
Satellite	Monitor-E
Status (Sept 2005)	Operational – Utilisation period: 2005 to ~ 2008
Mission	Vegetation monitoring, Digital Elevation Model (DEM) by in-orbit stereoscopy
Instrument type	Single VNIR channel (0.51-0.85 μm), SNR @ % albedo
Scanning technique	Bushbroom, 12000 pixel/line, swath 94 km addressable within an area of regard of 730 km
Coverage/cycle	Global coverage in 26 days, in daylight; locally more frequent by strategic pointing
Resolution (s.s.p.)	8 m IFOV

PAN-A, PAN-F	Panchromatic Cameras
Satellite	IRS-P5 (CartoSat-1)
Status (mid-2005)	Operational – Utilisation period: 2005 to ~ 2011
Mission	Digital Elevation Model (DEM) by in-orbit stereoscopy
Instrument type	Single VIS channel (0.50-0.75 μm), SNR @ % albedo
Scanning technique	Bushbroom, 12000 pixel/line, swath 30 km; PAN-A aft- view 10°, PAN-F fore- view 26°
Coverage/cycle	Global coverage in 126 days, in daylight

Resolution (s.s.p.)	2.5 m IFOV
----------------------------	------------

POAM	Polar Ozone and Aerosol Measurement
Satellites	SPOT-3 (POAM-2), SPOT-4 (POAM-3)
Status (mid-2005)	Operational (on SPOT-4) - Utilisation period: 1993 to ~ 2007
Mission	Atmospheric chemistry in high troposphere and stratosphere. Species: H ₂ O, NO ₂ , O ₂ , O ₃ and aerosol
Instrument type	9-channel photometer operating in the range 350-1024 nm (POAM-3) or 350-1064 nm (POAM-2)
Scanning technique	Limb scanning in solar occultation; vertical range 10-60 km
Coverage/cycle	N/A (few tens of events/day limited to latitudes above ~ 60°)
Resolution	300 km (horizontal), 0.6 km (vertical)

POLDER	Polarization and Directionality of the Earth's Reflectances
Satellites	PARASOL, ADEOS-1, ADEOS-2
Status (mid-2005)	Operational (on PARASOL) - Utilisation period: 2004 to ~ 2007 (ADEOS-1: 1996-97; ADEOS-2: 2002-03)
Mission	Aerosol, ocean colour, vegetation, Bidirection Reflectance Distribution Function (BRDF)
Instrument type	9-wavelength radiometer with 3 polarisations at three wavelengths (total: 15 channels)
Scanning technique	242 x 274 CCD arrays, 2200 km swath, each earth's spot viewed from more directions as satellite moves
Coverage/cycle	Near-global coverage each day in daylight.
Resolution (s.s.p.)	6 km IFOV (PARASOL), 6.5 km IFOV (ADEOS)

Central wavelength		Band width	Polarisation		Radiometric accuracy (SNR)
PARASOL	ADEOS		PARASOL	ADEOS	
-	443 nm	20 nm	-	three @ % albedo
443 nm	443 nm	20 nm	none	none @ % albedo
490 nm	490 nm	20 nm	three	none @ % albedo
565 nm	565 nm	20 nm	none	none @ % albedo
670 nm	670 nm	20 nm	three	three @ % albedo
763 nm	763 nm	10 nm	none	none @ % albedo
765 nm	765 nm	40 nm	none	none @ % albedo
865 nm	865 nm	40 nm	three	three @ % albedo
910 nm	910 nm	20 nm	none	none @ % albedo
1020 nm	-	20 nm	none	 @ % albedo

Poseidon-2	Poseidon-2
Satellite	Jason (it follows NRA + SSALT of TOPEX-Poseidon and will be followed by Poseidon-3 on OSTM)
Status (Sept 2005)	Operational – Utilised in the period 2001 to ~ 2006. To continue with Poseidon-3 on OSTM till ~ 2013
Mission	Ocean topography, significant wave height, wind speed
Instrument type	Two-frequency (5.3 and 13.58 GHz) radar altimeter
Scanning technique	Nadir-only viewing, sampling at 30 km intervals along track
Coverage/cycle	17100 measurements/day at 30 km intervals – Global coverage (30 km average spacing) in 30 days
Resolution	30 km IFOV

PR	Precipitation Radar
Satellite	TRMM

Status (Sept 2005)	Operational – Utilised in the period 1997 to ~ 2006
	TO BE COMPILED

PRISM	Panchromatic Remote-sensing Instrument for Stereo Mapping
Satellite	ALOS
Status (mid-2005)	Close to be launched – To be utilised in the period 2005 to ~ 2010
Mission	Digital Elevation Model (DEM) by stereoscopy
Instrument type	Single-channel (0.52-0.77 μm) radiometer with three views, fore-, nadir and aft- ($\pm 24^\circ$ and nadir)
Scanning technique	Push-broom, nadir image 28000 pixel/line / 70 km swath, fore- and aft- 14000 pixel/line / 35 km swath
Coverage/cycle	Global coverage in 46 days for nadir imagery, 96 days for stereoscopy
Resolution (s.s.p.)	2.5 m IFOV for the nadir image

RA, RA-2	Radar Altimeter
Satellites	ERS-1, ERS-2 and Envisat
Status (Sept 2005)	Operational – Utilised in the period 1991 to ~ 2007
	TO BE COMPILED

SAPHIR	Sondeur Atmospherique du Profil d'Humidite Intertropicale par Radiometrie
Satellite	Megha-Tropiques
Status (end-2005)	Planned - To be utilised in the period 2009 to ~ 2014
Mission	Humidity sounding in nearly-all-weather conditions. Also precipitation
Instrument type	6-channel MW radiometer
Scanning technique	Cross-track: 127 steps of 10 km ssp, swath 1700 km - Along-track: one 10-km lines each 1.6 s
Coverage/cycle	Intertropical coverage 2 to 5 times/day depending on latitude (max coverage at 15°N and 15°S)
Resolution (s.s.p.)	10 km IFOV

Central frequency (GHz)	Bandwidth (MHz)	Polarisation	Radiometric accuracy (NE Δ)
183.31 \pm 0.2	200	V	2.35 K
183.31 \pm 1.1	350	V	1.45 K
183.31 \pm 2.8	500	V	1.36 K
183.31 \pm 4.2	700	V	1.38 K
183.31 \pm 6.8	1200	V	1.03 K
183.31 \pm 11	2000	V	1.10 K

ScaRaB	Scanner for Radiation Budget
Satellites	Megha-Tropiques (also Meteor-3-7 and Resurs-O1-4)
Status (mid-2005)	Planned - To be utilised in the period 2009 to ~ 2014 (1994-95 on Meteor-3-7, in 1998-99 on Resurs-O1-4)
Mission	Earth radiation budget at Top Of Atmosphere (TOA)
Instrument type	4-channel radiometer, two broad-band, two narrow-band
Scanning technique	Cross-track: 51 pixel/scan, swath 3200 km - Along-track: 1 scan / 6 s
Coverage/cycle	Intertropical coverage 2 to 6 times/day depending on latitude (max coverage at 15°N and 15°S)
Resolution (s.s.p.)	40 km IFOV

Channel	Spectral interval	Noise Equivalent Radiance	Absolute accuracy	SNR
Short-wave	0.2 - 4.0 μm	$< 0.5 \text{ W m}^{-2} \text{ sr}^{-1}$	1 to 2 %	850
Total radiance	0.2 - 50 μm	$< 0.5 \text{ W m}^{-2} \text{ sr}^{-1}$	1 to 2 %	1000
VIS	0.55 – 0.65 μm	$< 1.0 \text{ W m}^{-2} \text{ sr}^{-1}$	1 to 2 %	120
TIR	10.5-12.5 μm	$< 0.5 \text{ W m}^{-2} \text{ sr}^{-1}$	1 to 2 %	60

SCIAMACHY	Scanning Imaging Absorption Spectrometer for Atmospheric Cartography
Satellite	Envisat
Status (Sept 2005)	Operational – Utilised in the period 2002 to ~ 2007
	TO BE COMPILED

SeaWiFS	Sea-viewing Wide Field-of-view Sensor
Satellite	SeaStar
Status (Sept 2005)	Operational – Utilised in the period 1997 to ~ 2006
	TO BE COMPILED

SeaWinds	SeaWinds
Satellites	QuickSCAT and ADEOS-2
Status (mid-2005)	Operational (on QuickSCAT) - Utilisation period: 1999 to ~ 2006
Mission	Sea surface wind vector
Instrument type	Ku-band radar scatterometer (13.4 GHz)
Scanning technique	Conical scanning, two beams, to provide four views of each spot from different angles; swath 1800 km
Coverage/cycle	Global coverage each day
Resolution	50 km

TANSO-FTS	Thermal And Near infrared Sensor for carbon Observations - Fourier Transform Spectrometer
Satellite	GOSAT
Status (mid-2005)	Under development – To be utilised in the period 2008 to ~ 2013
Mission	Measurements of CO ₂ , CH ₄ and other species
Instrument type	4-band SWIR/TIR interferometer
Scanning technique	Cross-track mechanical pointing, swath 790 km
Coverage/cycle	Global coverage in 3 days
Resolution (s.s.p.)	10.5 km IFOV

Spectral range (µm)	Spectral range (cm⁻¹)	Spectral resolution (unapodised)	Radiometric accuracy (NEΔT or SNR)
14.28 - 5.55 µm	700 - 1800 cm ⁻¹	0.2 cm ⁻¹ K @ 280 K
1.92 – 2.08 µm	4800 - 5200 cm ⁻¹	0.2 cm ⁻¹	300 @ 30 % albedo
1.56 – 1.72 µm	5800 - 6400 cm ⁻¹	0.2 cm ⁻¹	300 @ 30 % albedo
0.757 – 0.775 µm	12900 - 13200 cm ⁻¹	0.5 cm ⁻¹	300 @ 30 % albedo

TANSO-CAI	Thermal And Near infrared Sensor for carbon Observations - Cloud and Aerosol Imager
Satellite	GOSAT
Status (mid-2005)	Under development – To be utilised in the period 2008 to ~ 2013
Mission	Cloud and aerosol observation
Instrument type	4-channel UV/ VIS/NIR/SWIR radiometer
Scanning technique	Push-broom, 2000 pixel/line (three VNIR channels), 500 pixels/line (SWIR channel); 1000 km swath
Coverage/cycle	Global coverage in 3 days
Resolution (s.s.p.)	0.5 km IFOV in VNIR, 1.5 km in SWIR

Central wavelength	Bandwidth	Radiometric accuracy (SNR)
380 nm	20 nm	200 @ 15 % albedo
674 nm	20 nm	200 @ 11 % albedo

870 nm	20 nm	200 @ 11 % albedo
1600 nm	90 nm	200 @ 10 % albedo

TES	Tropospheric Emission Spectrometer
Satellite	EOS-Aura
Status (Sept 2005)	Operational – Utilised in the period 2004 to ~ 2010
	TO BE COMPILED

Végétation	Végétation
Satellites	SPOT-4, SPOT-5
Status (mid-2005)	Operational - Utilisation period: 1998 to ~ 2009
Mission	Vegetation observation
Instrument type	4-channel VIS/NIR/SWIR radiometer
Scanning technique	Bushbroom, 1728 pixel/line, swath 2200 km
Coverage/cycle	Near-global coverage in one day
Resolution (s.s.p.)	1.15 km IFOV

Central wavelength	Spectral interval	Radiometric accuracy (SNR)
0.450 μm	0.43 – 0.47 μm @ % albedo
0.645 μm	0.61 – 0.68 μm @ % albedo
0.835 μm	0.78 – 0.89 μm @ % albedo
1.645 μm	1.58 – 1.75 μm @ % albedo